

Algebraic Structures for Bundle Gerbes and the Wess-Zumino Term in Conformal Field Theory

Dissertation
zur Erlangung des Doktorgrades
der Fakultät für Mathematik, Informatik
und Naturwissenschaften
der Universität Hamburg

vorgelegt
im Department Mathematik
von

Konrad Waldorf

aus Wermelskirchen

Hamburg
2007

Als Dissertation angenommen vom Department
Mathematik der Universität Hamburg

auf Grund der Gutachten von Prof. Dr. Christoph Schweigert
und Prof. Dr. Birgit Richter

Hamburg, den 19. Dezember 2007

Prof. Dr. Jens Struckmeier
Leiter des Departments Mathematik

Table of Contents

Introduction	III
Outline	VI
1 Motivation:	
Bundle Gerbes and the Wess-Zumino Term	1
1.1 From Line Bundles to Bundle Gerbes	1
1.2 Stable Isomorphisms between Bundle Gerbes	6
1.3 Deligne Cohomology	12
1.4 Bundle Gerbes over Lie Groups	22
1.5 Surface Holonomy	26
1.6 Application: Sigma Models with Wess-Zumino Term	31
2 Bundle Gerbes as a 2-Category	37
2.1 Morphisms between Bundle Gerbes revisited	37
2.2 Composition of Morphisms	43
2.3 The 2-Category of Bundle Gerbes	48
2.4 Descent Theory for Morphisms	54
2.5 Pullbacks, Tensor Products and Duality	58
2.6 The Čech-Deligne Complex as a 2-Category	64
3 Algebraic Structure for Bundle Gerbes I:	
Modules and Bimodules	68
3.1 D-Branes, relative Cohomology and Gerbe Modules	68
3.2 Bi-Branes I: Birelative Cohomology	75
3.3 Bi-Branes II: Gerbe Bimodules	81
3.4 Application: Worldsheets with Boundaries and Defects	85
3.5 Symmetric Branes in Wess-Zumino-Witten Models	89
3.6 Towards a geometric Realization of the Verlinde Algebra	92
4 Algebraic Structure for Bundle Gerbes II:	
Jandl Structures	96
4.1 Oriented, orientable and unoriented Surfaces	96
4.2 Jandl Structures on Bundle Gerbes	101
4.3 Unoriented Surface Holonomy	108
4.4 Local Description of unoriented Surface Holonomy	111
4.5 Application: Sigma Models for unoriented Surfaces	116
5 Twisted Equivariant Bundle Gerbes	
and finite Group Cohomology	121
5.1 Twisted equivariant Structures on Bundle Gerbes	121

5.2 Twisted equivariant Deligne Cohomology	128
5.3 Obstruction Theory and Classification	132
5.4 Quotients of Equivariant Bundle Gerbes	136
5.5 Jandl Structures on Quotient Bundle Gerbes	143
5.6 Application: Wess-Zumino-Witten Orientifolds	148
Summary	154
Zusammenfassung (Summary in german)	156
Bibliography	158
List of Notations	162
Index	165

Introduction

This thesis is based on a link between differential geometry and quantum field theory, which has been developed during the past twenty years by both mathematicians and physicists. On the mathematical side it concerns connections on gerbes over a smooth manifold, on the physical side two-dimensional non-linear sigma models with Wess-Zumino term on this manifold. Such a sigma model assigns to any smooth map $\phi : \Sigma \rightarrow M$ between surfaces Σ and the manifold M a so-called Feynman amplitude: a complex number $\mathcal{A}(\phi)$ which is the integrand in the path integral of the quantum theory. Sigma models are for instance considered in string theory. Here, Σ parameterizes the surface that is swept out by a string moving through M . It has now turned out that connections on gerbes provide an important contribution to the definition of the Feynman amplitude $\mathcal{A}(\phi)$.

A first indication for a link between gerbes and sigma models with Wess-Zumino term is the observation that both theories develop remarkable properties when considered on a Lie group $M = G$. In order to motivate this, let us exhibit some details of the theory of gerbes. Gerbes on a smooth manifold M are geometric objects whose isomorphism classes parameterize the cohomology group $H^3(M, \mathbb{Z})$. Such a situation is called a geometric realization; it is analogous to a classical result of Weil that identifies isomorphism classes of complex line bundles with elements of the cohomology group $H^2(M, \mathbb{Z})$ [Wei52]. In this identification the cohomology class associated to a line bundle is just its first Chern class, while in the case of gerbes the class of a gerbe \mathcal{G} is called its Dixmier-Douady class $dd(\mathcal{G}) \in H^3(M, \mathbb{Z})$.

There are various approaches to the actual geometric definition of a gerbe, among them projective Hilbert space bundles [DD63], sheaves of groupoids [Gir71], bundle gerbes [Mur96] and 2-bundles [Bar04, BS07]. In this thesis we use bundle gerbes: they are manifestly finite-dimensional objects defined by basic differential-geometric structures.

The particular behaviour of gerbes over Lie groups becomes clear if one takes into account that for an important class of Lie groups, namely for compact, simple and simply-connected ones, the classifying cohomology group $H^3(G, \mathbb{Z})$ is canonically isomorphic to the integers. These Lie groups are thus not only Riemannian manifolds, but also carry a family of canonical gerbes \mathcal{G}_k , one for each integer k . While this is based on purely topological properties, the Lie group structure can be used even further. In particular in the case of bundle gerbes explicit constructions of the canonical gerbes \mathcal{G}_k could be developed by Lie-theoretical considerations [GR02, Mei02, GR03]. The existence of these constructions emphasizes the role of Lie groups among all manifolds on which gerbes can live.

On the physical side, the prominent role of sigma models on Lie groups can be traced back to a paper by Witten, where he defines the amplitude $\mathcal{A}(\phi)$

of the sigma model in such a way that the resulting quantum field theory is conformally invariant [Wit84]. This has been achieved by adding a new term to the usual kinetic term: this new term is called the Wess-Zumino term, and the resulting sigma models are known as Wess-Zumino-Witten models. They are of great importance in theoretical physics: they describe physical systems with non-abelian symmetries, gauge sectors in heterotic string compactifications and are a starting point for many constructions in conformal field theory.

The observation that Lie groups are important both for gerbes and for sigma models is indeed essential for the link between the two. Furthermore, Witten's definition of the Wess-Zumino term is restricted to exactly that class of Lie groups over which we have already found canonical gerbes, i.e. to compact, simple and simply-connected Lie groups. Let us therefore have a closer look at Witten's definition of the Wess-Zumino term. We shall thus explain how to assign a complex number $\mathcal{A}^{\text{WZ}}(\phi)$ to a smooth map $\phi : \Sigma \rightarrow G$. Here one has to restrict oneself to oriented and closed surfaces Σ . First, we consider a three-dimensional oriented manifold B whose boundary is the surface Σ ; such a manifold always exists, but is in general not unique. Now two properties of the Lie group G become important. The first is the vanishing of its second fundamental group, $\pi_2(G) = 0$. This allows one to choose an extension $\Phi : B \rightarrow G$ of the map ϕ , but again, this extension will not be unique. Secondly, there exists a canonical bi-invariant 3-form η on G characterized by the property that its de Rham cohomology class coincides with the image of $1 \in \mathbb{Z} = H^3(G, \mathbb{Z})$ under the homomorphism $H^3(G, \mathbb{Z}) \rightarrow H^3(G, \mathbb{R}) \cong H_{\text{dR}}^3(G)$. Equipped with the extension Φ and this 3-form η , Witten's definition of the Wess-Zumino term is

$$S_k^{\text{WZ}}(\phi) := k \int_B \Phi^* \eta,$$

where k is a real parameter. An important question is now to what extent this expression depends on the choices of B and Φ . According to Witten, the above-mentioned property of the 3-form η ensures that Wess-Zumino terms based on different choices differ by a number in $k\mathbb{Z}$. If one now demands k to be an integer, the amplitude

$$\mathcal{A}_k^{\text{WZ}}(\phi) := \exp(2\pi i S_k^{\text{WZ}}(\phi))$$

is independent of all choices. This amplitude, together with a second factor coming from the kinetic term, defines the Wess-Zumino-Witten model at level k . The condition that the level is an integer can actually be understood analogously to Dirac's quantization of the electric charge [GR02].

In order to finally understand the link between the amplitude $\mathcal{A}_k^{\text{WZ}}(\phi)$ and the canonical gerbes \mathcal{G}_k , we need to introduce another aspect of these geometric objects, namely connections. Connections on gerbes reveal more similarities between complex line bundles and gerbes, in addition to the analogous classification by the cohomology groups $H^n(M, \mathbb{Z})$ for $n = 2$ and 3 , respectively.

A possible way of understanding the algebraic aspects of all these analogies is provided by Deligne cohomology [Del91, Bry93]. In recent years, the geometric aspects have motivated the use of higher category theory; gerbes for instance have the structure of a 2-category [Ste00], see also [Wal07]. This 2-category can be viewed as the third step in a ladder of geometric structures over a manifold: a set of $U(1)$ -valued functions, a category of complex line bundles, a 2-category of gerbes, and so forth.

Let us return to connections on gerbes and discover some of the analogies between line bundles and gerbes. A connection on a gerbe \mathcal{G} over a smooth manifold M has two characteristic quantities: its curvature, a closed 3-form on M , and its holonomy, a complex number $\text{Hol}_{\mathcal{G}}(\phi)$ for each smooth map $\phi : \Sigma \rightarrow M$ from a closed and oriented surface Σ to M . Not only are these two quantities themselves similar to the respective quantities of connections on complex line bundles, but also their properties. First of all, the relation between the curvature of a connection on a line bundle and its first Chern class – fundamental for Chern-Weil theory – persists for gerbes: the curvature $H \in \Omega^3(M)$ of a connection on a gerbe \mathcal{G} represents the image of its Dixmier-Douady class $dd(\mathcal{G})$ under the homomorphism $H^3(M, \mathbb{Z}) \rightarrow H_{\text{dR}}^3(M)$. A second similar property is the relation between curvature and holonomy: for a three-dimensional, oriented manifold B and a smooth map $\Phi : B \rightarrow M$, this relation is

$$\exp\left(2\pi i \int_B \Phi^* H\right) = \text{Hol}_{\mathcal{G}}(\Phi|_{\partial B}).$$

Just as the analogous relation for connections on line bundles, this equation can be understood as a generalization of Stokes's Theorem: the integral of a closed 3-form over a three-dimensional manifold is reduced to a calculation on the boundary. However, while Stokes's Theorem is restricted to exact 3-forms, the curvature H of a connection on a gerbe is generally not exact.

It turns out that compact, simple and simply-connected Lie groups do not only carry the before-mentioned canonical gerbes \mathcal{G}_k , but also provide canonical connections on these. Their curvature H_k is just the 3-form $k\eta$ from the definition of the Wess-Zumino term. From the above relation between curvature and holonomy of connections on gerbes then follows

$$\mathcal{A}_k^{\text{WZ}}(\phi) = \text{Hol}_{\mathcal{G}_k}(\phi).$$

We have thus interpreted Witten's original Wess-Zumino term as the holonomy of a connection on a gerbe. This interpretation has first been discovered in terms of Deligne cohomology [Gaw88]. It provides significant advantages.

First, the holonomy of a connection on a gerbe over a manifold M is defined independently of topological properties of M . It is hence possible to consider for instance Wess-Zumino-Witten models on non-simply connected Lie groups, for which the original definition of the Wess-Zumino term fails because the second fundamental group may not vanish. The only thing one needs now is a gerbe with connection; the Wess-Zumino term is then defined

as the holonomy of this connection. Indeed, all relevant gerbes with connection on compact and simple Lie groups are classified, in the case of bundle gerbes there even exist concrete constructions [GR03]. An important observation on Wess-Zumino-Witten models defined by connections on bundle gerbes is that they are no longer parameterized by their level k : there may be no or even several Wess-Zumino-Witten models for a given level k .

Of course these considerations extend to arbitrary manifolds M , and one can now discuss sigma models with Wess-Zumino term on the basis of a given gerbe with connection over M . We have thus arrived at the advertised link between differential geometry and quantum field theory.

The study of sigma models with Wess-Zumino term benefits a lot from this link, not only with a view to the target space M of the model, but also concerning the class of permitted surfaces Σ . As we have described, both the holonomy of a connection on a gerbe and the original definition of the Wess-Zumino term require closed and oriented surfaces. Connections on gerbes, however, have the potential to discuss extensions of the notion of holonomy to a larger class of surfaces in a purely mathematical way. An interesting class consists for instance of oriented surfaces with boundary. In this case, it has turned out that a well-defined notion of holonomy for such surfaces requires the choice of additional structures, so-called gerbe modules [Kap00, CJM02]. Applied to sigma models, these gerbe modules have substantially improved the understanding of D-branes. In particular, it was now possible to study symmetric D-branes in Wess-Zumino-Witten models on non-simply connected Lie groups [Gaw05]. Furthermore, gerbe modules allow a geometrical description of the relationship between twisted K-theory and D-brane charges [BCM⁺02, Wit98].

In this thesis, we introduce further extensions of the holonomy of connections on gerbes and study their application to quantum field theory. In the following, we shall give an outline.

Outline

Gerbe modules extend the notion of holonomy of a gerbe with connection from closed and oriented surfaces to oriented surfaces with boundary. Beyond that, the applications of holonomy to Wess-Zumino terms in sigma models motivate further generalizations, namely to

- 1.) surfaces with defect lines; these are in the simplest case embedded circles which divide a surface into several regions on which different gerbes with connection are relevant, and to
- 2.) unoriented, in particular unorientable surfaces, like the Klein bottle.

In this thesis, we introduce new structures for bundle gerbes with connection and use them to define holonomy in both situations. As applications of these

generalized holonomies, we discuss Wess-Zumino terms in sigma models for worldsheets with defect lines and unoriented worldsheets.

In the first chapter we review fundamental notions from the theory of bundle gerbes and their connections, and expand on important points mentioned in the introduction. Among other things, we describe the classifying cohomology theory, Deligne cohomology, and the canonical gerbes over compact, simple and simply-connected Lie groups. We discuss in detail the well-known definition of holonomy for closed oriented surfaces and their application to Wess-Zumino terms in sigma models.

In the second chapter we investigate the algebraic structure of bundle gerbes; here we come to the first original results of this thesis. Bundle gerbes over a smooth manifold M form a 2-category: there are objects as in an ordinary category, but instead of Hom-sets it has Hom-categories. We give a new definition of these Hom-categories, which improves the existing definition from [Ste00]: first of all there are now also non-invertible morphisms, and secondly it enables a very elegant definition of the composition rule.

Bundle gerbes allow several natural constructions like pullbacks, tensor products and a duality, which we describe here for the first time as structures on a 2-category. We then show that each of the new Hom-categories carries the structure of a module category over the monoidal category of flat vector bundles over M . These fundamental results about the new Hom-categories are of crucial importance for the subsequent chapters.

We begin the third chapter with an overview of gerbe modules and their applications to D-Branes and Wess-Zumino terms in sigma models for worldsheets with boundary [Gaw05]. We show that the non-invertible morphisms in our new Hom-categories enable a clearer and more conceptual formulation of holonomy for surfaces with boundary.

To discuss defect lines, we introduce gerbe bimodules and the related notion of a bi-brane. In the case of a defect line that separates two regions, which are assigned to manifolds M_1 and M_2 with gerbes \mathcal{G}_1 and \mathcal{G}_2 , respectively, a bi-brane is a submanifold Q of the cartesian product $M_1 \times M_2$ as well as a gerbes bimodule for the pullbacks of \mathcal{G}_1 and \mathcal{G}_2 to Q . While D-branes in topologically simple situations are described by classes in relative cohomology, we show a similar result for bi-branes; for this purpose, we introduce a new cohomology theory which is based on two manifolds and a submanifold of their cartesian product.

In the applications to Wess-Zumino terms we concentrate particularly on Wess-Zumino-Witten models, for which only special, so-called symmetric D-branes and bi-branes are relevant. In case that both manifolds of a bi-brane are a fixed Lie group G , we show that the relevant submanifolds Q are biconjugacy classes in $G \times G$. Pursuing the relationship between Wess-Zumino-Witten models and conformal field theories, we discover a new geometric realization of the moduli space of flat connections on the three-punctured sphere. This hints a geometric realization of the Verlinde algebra, motivated by physics.

In the fourth chapter we turn to the holonomy for unoriented surfaces. It requires a further structure on a bundle gerbe with connection, which we call Jandl structure. A Jandl structure consists of an involution of the base manifold, and each an object and a morphism of one of the Hom-categories, which we have introduced in the second chapter. We study the holonomy for unoriented surfaces defined by Jandl structures. For instance, we deduce a local formulation which we evaluate on the Klein bottle. Then we show how the theory of gerbes with Jandl structure can be applied to Wess-Zumino terms in unoriented sigma models. Unoriented sigma models with Wess-Zumino term have been considered in string theory for a long time [BPS92, PSS95b, PSS95a]. On the basis of the theory of gerbes with Jandl structure introduced in this thesis, we are in particular able to reproduce some results of this research in a geometrical way. This concerns the 2-dimensional torus and the Lie groups $SU(2)$ and $SO(3)$.

The goal of the fifth chapter is the classification of all those bundle gerbes with Jandl structure which are relevant for Wess-Zumino-Witten models on compact simple Lie groups. Since each of these Lie groups is a quotient of its simply-connected cover by a finite group, we introduce a general theory of twisted equivariant structures on bundle gerbes with connection.

These combine the action of a finite group Z on a smooth manifold M with the involution arising as one ingredient of the Jandl structure. We show that a gerbe equipped with a twisted equivariant structure over M defines a gerbe with Jandl structure over the quotient M/Z , and that this relationship is a bijection. According to these geometrical structures, we introduce a twisted equivariant version of Deligne cohomology, and use it to classify gerbes with twisted equivariant structures. We discuss the application of these results to the canonical gerbes over compact, simple and simply-connected Lie groups. It leads us to a complete classification of all unoriented Wess-Zumino-Witten models on compact simple Lie groups.

I want to express my gratitude to Christoph Schweigert for the past years, in which I wrote this thesis under his outstanding support. His lively interest on every little progress, his dedication in each aspect of my graduation and his confidence in me to let me talk at important conferences right from the start motivated me always very much. Also many thanks to my office mates Niko Wilbert, Katarina Kring and Hannah König, and the remaining members of our group for the nice and familiar atmosphere. I thank Jürgen Fuchs and Urs Schreiber for the fruitful collaboration which led to parts of this thesis; likewise I thank Krzysztof Gawędzki and Rafał Suszek, additionally for their kind hospitality during two stays at the École normale Supérieure in Lyon. Financial support by the Rudolf und Erika Koch-Stiftung, Hamburg, and by the German-Israeli-Foundation (GIF) is gratefully acknowledged.

The chapters of this thesis are based on the following publications:

Chapter 1: K. Waldorf, *Surface Holonomy*, to appear in the „Handbook of Pseudo-Riemannian Geometry and Supersymmetry“, V. Cortes (ed.), European Mathematical Society, Zürich, 2006.

Chapter 2: K. Waldorf, *More Morphisms between Bundle Gerbes*, Theory Appl. Categories, Vol. 18, No. 9, 2007, pp. 240-273.

Chapter 3: J. Fuchs, C. Schweigert and K. Waldorf, *Bi-Branes: Target Space Geometry for World Sheet topological Defects*, submitted to the Journal of Geometry and Physics.

Chapter 4: U. Schreiber, C. Schweigert and K. Waldorf, *Unoriented WZW Models and Holonomy of Bundle Gerbes*, Commun. Math. Phys. **274** (1), 31–64 (2007).

Chapter 5: K. Gawędzki, R. R. Suszek and K. Waldorf, *WZW Orientifolds and Finite Group Cohomology*, submitted to Commun. Math. Phys.

Chapter 1

Motivation:

Bundle Gerbes and the Wess-Zumino Term

This first chapter is to serve as an introduction into the theory of bundle gerbes, and shall provide the reader with a deeper understanding of the relation between the surface holonomy of a bundle gerbe and the Wess-Zumino term; this relation is essential for the applications to sigma models. We give the basic definitions and review relevant results.

1.1 From Line Bundles to Bundle Gerbes

As indicated in the introduction, bundle gerbes can be understood as categorified line bundles. One of the basic features of a complex line bundle $L \rightarrow M$ over a smooth manifold M is that it is locally trivializable. This is usually stated with respect to an open cover, but here we state it with respect to a surjective submersion $\pi : Y \rightarrow M$. Notice that we can produce such a surjective submersion from any open cover $\mathfrak{U} = \{V_i\}_{i \in I}$ of M by defining Y as the disjoint union of its patches,

$$Y := M_{\mathfrak{U}} := \bigsqcup_{i \in I} V_i,$$

and π as the inclusion $V_i \hookrightarrow M$ on each component. With this notation, a line bundle is locally trivializable, if there is a surjective submersion $\pi : Y \rightarrow M$ and a commutative diagram

$$\begin{array}{ccc} Y \times \mathbb{C} & \longrightarrow & L \\ \downarrow & & \downarrow \\ Y & \xrightarrow{\pi} & M, \end{array}$$

meaning that the pullback line bundle π^*L is isomorphic to the trivial line bundle $\mathbf{1}$ over Y .

A local trivialization defines a transition function $g : Y^{[2]} \rightarrow \mathbb{C}^\times$, where we denote by $Y^{[k]} := Y \times_M \dots \times_M Y$ the k -fold fibre product of Y with itself. If the line bundle L is equipped with an hermitian metric, the transition function can furthermore be normalized to values in $U(1)$. Notice that since $\pi : Y \rightarrow M$ is a surjective submersion, the fibre products $Y^{[k]}$ are again smooth manifolds in such a way that the canonical projections $\pi_{i_1 \dots i_r} : Y^{[k]} \rightarrow Y^{[r]}$ are smooth maps. The transition function g is smooth and satisfies the cocycle condition

$$\pi_{12}^* g \cdot \pi_{23}^* g = \pi_{13}^* g \quad (1-1)$$

over $Y^{[3]}$. In the particular case that Y comes from an open cover \mathfrak{U} , the fibre product $Y^{[k]}$ is the disjoint union of all k -fold intersections of the open sets V_i . Accordingly, the transition function g decomposes into smooth functions $g_{ij} : V_i \cap V_j \rightarrow U(1)$, and the cocycle condition (1-1) becomes $g_{ij} \cdot g_{jk} = g_{ik}$ as functions defined on $V_i \cap V_j \cap V_k$.

Bundle gerbes do not have a total space like line bundles. For the definition of a bundle gerbe we step in after having locally trivialized, i.e. after having chosen a surjective submersion $\pi : Y \rightarrow M$,

$$\begin{array}{ccc} & ? & \\ & \downarrow & \\ Y & \xrightarrow{\pi} & M. \end{array}$$

Now we define the bundle gerbe analogous to what remains of the locally trivialized line bundle. We take the following point of view: if an hermitian line bundle generalizes $U(1)$ -valued functions, and its transition function is a $U(1)$ -valued function on $Y^{[2]}$, the transition data of a bundle gerbe should be a hermitian line bundle L over $Y^{[2]}$. The next steps are predicted: because we can not multiply line bundles like the pullbacks of the transition function g in (1-1), the cocycle condition has to be relaxed to an isomorphism

$$\mu : \pi_{12}^* L \otimes \pi_{23}^* L \rightarrow \pi_{13}^* L$$

of hermitian line bundles over $Y^{[3]}$ – called the *multiplication* of the bundle gerbe. To capture an essential aspect of the multiplication of functions, we demand that this isomorphism is associative.

It is straightforward to define a connection on a bundle gerbe. Consider first a unitary connection on an hermitian line bundle L over M . In a local trivialization $\pi : Y \rightarrow M$, this connection defines a 1-form $A \in \Omega^1(Y)$, which is related to the transition function g by

$$\frac{1}{i} g^{-1} dg = \pi_2^* A - \pi_1^* A.$$

Its curvature can be identified with a 2-form $\text{curv}(L) \in \Omega^2(M)$ that is given by dA_i on V_i . We call the pair (g, A) a cocycle for the line bundle L with

connection. For the bundle gerbe, we take a unitary connection on the hermitian line bundle L over $Y^{[2]}$ and impose that the isomorphism μ respects the connections. Additionally, we take a 2-form $C \in \Omega^2(Y)$ – called the *curving* – which has to be related to the connection on L by its curvature

$$\text{curv}(L) = \pi_2^* C - \pi_1^* C.$$

The connection on L together with the curving C form the connection on the bundle gerbe. It is shown in [Mur96] that every bundle gerbe admits a connection.

In some situations, for example generalized geometry [Hit01, Hit03], it seems to be adequate to discuss the two parts of a connection on a bundle gerbe, namely the connection on the line bundle and the curving, separately. Then, the solely choice of a connection on the line bundle is addressed as a *connective structure* on the bundle gerbe. In this thesis, however, we only discuss bundle gerbes with connective structure *and* curving.

Remark 1.1.1. To avoid a lot of cumbersome notation, we fix the following conventions for the complete thesis: we will only be concerned with bundle gerbes with connection, and hence just speak of *bundle gerbes*. We will also understand a *line bundle* as a hermitian line bundle with unitary connection. Accordingly, all *isomorphisms* between line bundles will be isomorphisms of line bundles which preserve the hermitian metric and the connections.

Summarizing, and using the above conventions, we are arrived at the following definition:

Definition 1.1.2 (Murray [Mur96]). *A bundle gerbe \mathcal{G} over M consists of a surjective submersion $\pi : Y \rightarrow M$, a 2-form $C \in \Omega^2(Y)$, a line bundle L over $Y^{[2]}$ and an isomorphism*

$$\mu : \pi_{12}^* L \otimes \pi_{23}^* L \rightarrow \pi_{13}^* L$$

of line bundles over $Y^{[3]}$. Two axioms have to be satisfied:

(G1) *the curvature of L is related to the curving by*

$$\text{curv}(L) = \pi_2^* C - \pi_1^* C.$$

(G2) *the multiplication is associative in the sense that the diagram*

$$\begin{array}{ccc} \pi_{12}^* L \otimes \pi_{23}^* L \otimes \pi_{34}^* L & \xrightarrow{\pi_{123}^* \mu \otimes 1} & \pi_{13}^* L \otimes \pi_{34}^* L \\ \downarrow 1 \otimes \pi_{234}^* \mu & & \downarrow \pi_{134}^* \mu \\ \pi_{12}^* L \otimes \pi_{24}^* L & \xrightarrow{\pi_{124}^* \mu} & \pi_{14}^* L \end{array}$$

of isomorphisms of line bundles over $Y^{[4]}$ is commutative.

Notice that in the formulation of axiom (G2) we have tacitly assumed that pullbacks and tensor products of line bundles are strictly associative. We will continue in doing so to avoid unessential notation. In the same way we proceed with pullbacks and fibre products of surjective submersions.

Similar as line bundles (i.e. hermitian line bundles with unitary connection) have a curvature 2-form, each bundle gerbe \mathcal{G} determines a closed 3-form $\text{curv}(\mathcal{G})$ on M , also called the *curvature of \mathcal{G}* : the derivative of axiom (G1) gives $\pi_1^*dC = \pi_2^*dC$, since the curvature of the line bundle L is a closed form. This means that dC descends along $\pi : Y \rightarrow M$ to a 3-form on M – the very curvature of the bundle gerbe \mathcal{G} . It is obviously a closed form, and it will turn out later that it has an integral class. We call a bundle gerbe *flat*, if its curvature vanishes.

To give an example of a bundle gerbe, we introduce *trivial bundle gerbes*. Just as for every 1-form $A \in \Omega^1(M)$ there is a trivial line bundle over M having this 1-form as its connection, we find a trivial bundle gerbe for every 2-form $\rho \in \Omega^2(M)$. The construction of this bundle gerbe is quite easy: as surjective submersion we take the identity $\text{id} : M \rightarrow M$, and the curving is the given 2-form ρ . The line bundle L is the trivial line bundle with the trivial flat connection, and the multiplication is the identity isomorphism between trivial line bundles. Now, axiom (G1) is satisfied since $\text{curv}(L) = 0$ and $\pi_1 = \pi_2 = \text{id}_M$. The associativity axiom (G2) is surely satisfied by the identity isomorphism. Thus we have defined a bundle gerbe, which we denote by \mathcal{I}_ρ . The curvature of a trivial gerbe is $\text{curv}(\mathcal{I}_\rho) = d\rho$. Another important class of examples of bundle gerbes is studied in §1.4.

Let us again assume that the surjective submersion $\pi : Y \rightarrow M$ of a bundle gerbe \mathcal{G} comes from an open cover $\{V_i\}_{i \in I}$ of M , which is exactly a gerbe in the sense of [Hit01]. Remember that we introduced the structure of a bundle gerbe – namely the line bundle L , the multiplication μ and the curving C – as analogues of a cocycle for a line bundle. To get a similar cocycle for the bundle gerbe, we trivialize once more: if the open sets V_i are chosen such that every non-empty double intersection $V_i \cap V_j$ is contractible, we are able to choose sections

$$\sigma_{ij} : V_i \cap V_j \rightarrow L$$

of unit length. Then, the connection on L pulls back to 1-forms A_{ij} on each double intersection $V_i \cap V_j$. Furthermore, over a three-fold intersection $V_i \cap V_j \cap V_k$, we can multiply two sections using the multiplication μ , and compare the result with a third section,

$$\mu(\sigma_{ij} \otimes \sigma_{jk}) = g_{ijk} \cdot \sigma_{ik}$$

via a smooth function $g_{ijk} : V_i \cap V_j \cap V_k \rightarrow \text{U}(1)$. Finally, the curving clearly restricts to a 2-form B_i on each open set V_i . Summarizing, we have extracted $\text{U}(1)$ -valued functions g_{ijk} on three-fold intersections, 1-forms A_{ij} on two-fold intersections, and 2-forms B_i on each open set. We call the collection (g, A, B)

a cocycle for the bundle gerbe \mathcal{G} . We deduce the following relations for such a cocycle:

$$\begin{aligned} g_{ijk} \cdot g_{ikl} &= g_{jkl} \cdot g_{ijl} \\ A_{ik} &= A_{ij} + A_{jk} + \frac{1}{i} g_{ijk}^{-1} dg_{ijk} \\ dA_{ij} &= B_j - B_i. \end{aligned} \tag{1-2}$$

The first one is a consequence of the associativity of μ from axiom (G2), the second describes the fact that μ preserves connections, and the third is the curvature condition (G1). These equations look like analogues of the two conditions for a cocycle for a line bundle namely

$$\begin{aligned} g_{ij} \cdot g_{jk} &= g_{ik} \\ \frac{1}{i} g_{ij}^{-1} dg_{ij} &= A_j - A_i. \end{aligned} \tag{1-3}$$

The natural way to sort these cocycles and the conditions thereon is Deligne cohomology, as it will be explained in §1.3.

There are three standard constructions one can do with bundle gerbes: duals, pullbacks and tensor products, all of them have been defined in [Mur96]. To each bundle gerbe \mathcal{G} , we associate a *dual bundle gerbe* \mathcal{G}^* as follows: It has the same surjective submersion $\pi : Y \rightarrow M$, but the dual line bundle L^* over $Y^{[2]}$ with multiplication

$$(\mu^*)^{-1} : \pi_{12}^* L^* \otimes \pi_{23}^* L^* \rightarrow \pi_{13}^* L^*,$$

and the negative curving $-C$. Accordingly, the curvature of the dual bundle gerbe is

$$\text{curv}(\mathcal{G}^*) = -\text{curv}(\mathcal{G}).$$

It is easy to see that the axioms are satisfied. To define the *pullback bundle gerbe* $f^*\mathcal{G}$ for a smooth map $f : N \rightarrow M$ we consider the pullback diagram

$$\begin{array}{ccc} Y_f & \xrightarrow{\tilde{f}} & Y \\ \pi_f \downarrow & & \downarrow \pi \\ N & \xrightarrow{f} & M \end{array}$$

of the surjective submersion $\pi : Y \rightarrow M$ of \mathcal{G} . Here, $\pi_f : Y_f \rightarrow N$ is again a surjective submersion, and the covering map \tilde{f} induces smooth maps

$$\tilde{f} : Y_f^{[k]} \rightarrow Y^{[k]}$$

on all fibre products. Now, the surjective submersion π_f , the pullback line bundle $\tilde{f}^* L$ over $Y_f^{[2]}$, the isomorphism $\tilde{f}^* \mu$ and the 2-form $\tilde{f}^* C$ over Y_f define the bundle gerbe $\tilde{f}^*\mathcal{G}$. The curvature of the pullback bundle gerbe satisfies

$$\text{curv}(f^*\mathcal{G}) = f^*\text{curv}(\mathcal{G}).$$

Finally, the *tensor product* of two bundle gerbes \mathcal{G}_1 and \mathcal{G}_2 is defined in the following way: we form the fibre product $Z := Y_1 \times_M Y_2$ regarded as a new surjective submersion $\zeta : Z \rightarrow M$ sending $(y_1, y_2) \in Y_1 \times Y_2$ to the point $\pi_1(y_1) = \pi_2(y_2)$ in M . The two projections $p_i : Z \rightarrow Y_i$ induce smooth maps between higher fibre products. We define the tensor product $\mathcal{G}_1 \otimes \mathcal{G}_2$ to have the surjective submersion $\zeta : Z \rightarrow M$, the line bundle $L := p_1^*L_1 \otimes p_2^*L_2$, the multiplication $\mu := p_1^*\mu_1 \otimes p_2^*\mu_2$ and the curving $p_1^*C_1 + p_2^*C_2$. For the curvatures this means

$$\text{curv}(\mathcal{G}_1 \otimes \mathcal{G}_2) = \text{curv}(\mathcal{G}_1) + \text{curv}(\mathcal{G}_2).$$

The tensor product for bundle gerbes is strictly associative, and we will discuss it in more detail in §2.5, considered as a monoidal structure on a certain 2-category.

The three constructions we just have described behave naturally for the trivial bundle gerbes \mathcal{I}_ρ :

$$\mathcal{I}_\rho^* = \mathcal{I}_{-\rho} \quad , \quad f^*\mathcal{I}_\rho = \mathcal{I}_{f^*\rho} \quad \text{and} \quad \mathcal{I}_{\rho_1} \otimes \mathcal{I}_{\rho_2} = \mathcal{I}_{\rho_1 + \rho_2}.$$

Furthermore, the trivial bundle gerbe \mathcal{I}_0 is a tensor unit, $\mathcal{G} \otimes \mathcal{I}_0 = \mathcal{G} = \mathcal{I}_0 \otimes \mathcal{G}$ for any bundle gerbe \mathcal{G} over M . The three constructions are also compatible with cocycles for the involved bundle gerbes: if (g, A, B) is a cocycle for a bundle gerbe \mathcal{G} , one can choose $(g^{-1}, -A, -B)$ as a cocycle for the dual bundle gerbe \mathcal{G} , and one can choose (f^*g, f^*A, f^*B) as a cocycle for the pullback bundle gerbe $f^*\mathcal{G}$. The discussion of cocycles for the tensor product of two bundle gerbes is postponed after Lemma 1.2.3 in the next section, where we also explain how to extract cocycles from bundle gerbes whose surjective submersion does not come from an open cover.

1.2 Stable Isomorphisms between Bundle Gerbes

To find the appropriate notion of equivalence between two bundle gerbes \mathcal{G}_1 and \mathcal{G}_2 , we assume again for a moment that their two surjective submersions $\pi_i : Y_i \rightarrow M$ both come from open covers. To compare the bundle gerbe structure, it would be natural to go to a common refinement of these covers. On the double intersections of this common refinement the line bundles L_1 and L_2 could be compared. For general surjective submersions π_1 and π_2 the common refinement amounts to consider the fibre product

$$Z := Y_1 \times_M Y_2,$$

which was also relevant for the tensor product of bundle gerbes. The two-fold intersections amount to consider $Z^{[2]} = Z \times_M Z$. The restriction of the line

bundle L_i to $Z^{[2]}$ is implemented by the pullback along the canonical map $p_i : Z^{[2]} \rightarrow Y_i^{[2]}$. A first idea is to require that the line bundles $p_1^*L_1$ and $p_2^*L_2$ are isomorphic. In fact, this was the original definition of an isomorphism between bundle gerbes [Mur96]. However, it turned out that this definition was too restrictive.

A solution to this was presented in [CMM97]: the line bundles should not be isomorphic but stably isomorphic in the sense that there is a line bundle A over Z and an isomorphism

$$p_1^*L_1 \otimes \zeta_2^*A \cong \zeta_1^*A \otimes p_2^*L_2$$

of line bundles over $Z^{[2]}$. Here ζ_1 and ζ_2 are the two projections from $Z^{[2]}$ to Z . It is natural to demand that the data of an isomorphism of bundle gerbes – the line bundle A and an isomorphism α as above – is compatible with the rest of the structure of the bundle gerbes, namely the curvings and the multiplications. Summarizing, we have

Definition 1.2.1 (Carey-Mickelsson-Murray [CMM97]). *A stable isomorphism $A : \mathcal{G}_1 \rightarrow \mathcal{G}_2$ between bundle gerbes \mathcal{G}_1 and \mathcal{G}_2 over M is a line bundle A over Z together with an isomorphism*

$$\alpha : p_1^*L_1 \otimes \zeta_2^*A \rightarrow \zeta_1^*A \otimes p_2^*L_2$$

of line bundles over $Z^{[2]}$. Two axioms have to be satisfied:

(SI1) the curvature of A is fixed by

$$\text{curv}(A) = p_2^*C_2 - p_1^*C_1,$$

(SI2) the isomorphism α commutes with the multiplications μ_1 and μ_2 of the bundle gerbes in the sense that the diagram

$$\begin{array}{ccc} p_1^*\pi_{12}^*L_1 \otimes p_1^*\pi_{23}^*L_1 \otimes \zeta_3^*A & \xrightarrow{p_1^*\mu_1 \otimes \text{id}} & p_1^*\pi_{13}^*L_1 \otimes \zeta_3^*A \\ \downarrow 1 \otimes \zeta_{23}^*\alpha & & \downarrow \zeta_{13}^*\alpha \\ \zeta_{12}^*p_1^*L_1 \otimes \zeta_2^*A \otimes \zeta_{23}^*p_2^*L_2 & & \\ \downarrow \zeta_{12}^*\alpha \otimes 1 & & \downarrow \\ \zeta_1^*A \otimes p_2^*\pi_{12}^*L_2 \otimes p_2^*\pi_{23}^*L_2 & \xrightarrow{1 \otimes p_2^*\mu_2} & \zeta_1^*A \otimes p_2^*\pi_{13}^*L_2 \end{array}$$

of isomorphisms of line bundles over $Z^{[3]}$ is commutative.

We call two bundle gerbes *stably isomorphic*, if there exists a stable isomorphism between them. This is in fact an equivalence relation, which is not at all a trivial result: the proof of its transitivity requires descent theory of

line bundles [Ste00]. We postpone the discussion of the transitivity and the symmetry of this equivalence relation to Chapter 2, where we introduce a generalized definition of morphisms between bundle gerbes, for which these problems become trivial.

Anyway, to give an example of a stable isomorphism, that at the same time shows that being stably isomorphic is a reflexive relation, we define the *identity stable isomorphism*

$$\text{id}_{\mathcal{G}} : \mathcal{G} \rightarrow \mathcal{G}$$

associated to any bundle gerbe \mathcal{G} over M . It is defined by the line bundle L of \mathcal{G} over $Z = Y \times_M Y = Y^{[2]}$ and the isomorphism λ of line bundles over $Z^{[2]}$ defined from the multiplication of \mathcal{G} by

$$\pi_{13}^* L \otimes \pi_{34}^* L \xrightarrow{\pi_{134}^* \mu} \pi_{14}^* L \xrightarrow{\pi_{124}^* \mu^{-1}} \pi_{12}^* L \otimes \pi_{24}^* L,$$

where we identified $Z^{[2]} = Y^{[4]}$, $y_1 = \pi_{13}$, $\zeta_2 = \pi_{34}$, $\zeta_1 = \pi_{12}$ and $y_2 = \pi_{24}$. Axiom (SI1) is the same as axiom (G1) for the bundle gerbe \mathcal{G} and axiom (SI2) follows from axiom (G2).

A second example is the *duality stable isomorphism*

$$\mathcal{D}_{\mathcal{G}} : \mathcal{G}^* \otimes \mathcal{G} \rightarrow \mathcal{I}_0$$

associated to any bundle gerbe \mathcal{G} [Wal07]. To construct it, notice that the bundle gerbe $\mathcal{G}^* \otimes \mathcal{G}$ has the surjective submersion $Y^{[2]} \rightarrow M$, the curving $\pi_2^* C - \pi_1^* C$ and the line bundle $\pi_{13}^* L^* \otimes \pi_{24}^* L$ over $Y^{[4]}$. We have $Z = Y^{[2]}$ and define $A := L^*$ as the line bundle of $\mathcal{D}_{\mathcal{G}}$ and

$$\delta_{\mathcal{G}} := \pi_{123}^* \mu^* \otimes \pi_{234}^* \mu^{-1} \otimes \text{id} : \pi_{13}^* L^* \otimes \pi_{24}^* L \otimes \pi_{34}^* L^* \rightarrow \pi_{12}^* L^*$$

as its isomorphism, which is an isomorphism of line bundles over $Z^{[2]} = Y^{[4]}$. Axiom (SI1) is satisfied because of axiom (G1), and axiom (SI2) can be reduced to several copies of axiom (G2).

The duality stable isomorphism is important for the following reason: we consider the set of stable isomorphism classes of bundle gerbes over M as a monoid, whose product is the tensor product \otimes defined in the previous section, and whose unit element is the trivial bundle gerbe \mathcal{I}_0 . The existence of the duality stable isomorphism infers that this monoid is even a group, the inverse elements represented by dual bundle gerbes.

There is another important point to notice from the definition of a stable isomorphism. Given two such stable isomorphisms

$$\mathcal{A} : \mathcal{G}_1 \rightarrow \mathcal{G}_2 \quad \text{and} \quad \mathcal{A}' : \mathcal{G}_1 \rightarrow \mathcal{G}_2$$

providing line bundles A and A' over the same manifold Z , to compare both stable isomorphisms it does not make sense to say that they are equal or not:

to compare line bundles one needs isomorphisms between them. This leads us forthright to the fact that bundle gerbes form a 2-category [Ste00, Wal07], which will be the subject of investigation in Chapter 2. Let us nevertheless introduce now the correct way to compare stable isomorphisms.

Definition 1.2.2 ([Ste00]). *Let $\mathcal{A} : \mathcal{G}_1 \rightarrow \mathcal{G}_2$ and $\mathcal{A}' : \mathcal{G}_1 \rightarrow \mathcal{G}_2$ be two stable isomorphisms. A 2-isomorphism*

$$\beta : \mathcal{A} \Rightarrow \mathcal{A}'$$

is an isomorphism $\beta : A \rightarrow A'$ of line bundles over Z , which is compatible with the isomorphisms α and α' in the sense that the diagram

$$\begin{array}{ccc} p_1^* L_1 \otimes \zeta_2^* A & \xrightarrow{\alpha} & \zeta_1^* A \otimes p_2^* L_2 \\ 1 \otimes \zeta_2^* \beta \downarrow & & \downarrow \zeta_1^* \beta \otimes 1 \\ p_1^* L_1 \otimes \zeta_2^* A' & \xrightarrow{\alpha'} & \zeta_1^* A' \otimes p_2^* L_2 \end{array}$$

of isomorphisms of line bundles over $Z^{[2]}$ is commutative.

We now use stable isomorphisms to obtain cocycles for general bundle gerbes and not just for those whose surjective submersion comes from an open cover. We prepare this by the following general consideration. For two surjective submersions $\xi : X \rightarrow M$ and $\pi : Y \rightarrow M$ we call a smooth map $f : X \rightarrow Y$ a *morphism of surjective submersions*, if $\xi = \pi \circ f$. Any such morphism induces smooth maps $f : X^{[k]} \rightarrow Y^{[k]}$ between the fibre products. Notice that if \mathcal{G} is a bundle gerbe over M with surjective submersion $\pi : Y \rightarrow M$, and $f : X \rightarrow Y$ is a morphism of surjective submersions, then the surjective submersion $\xi : X \rightarrow M$, the line bundle $f^* L$, the isomorphism $f^* \mu$ and the 2-form $f^* C$ form again a bundle gerbe over M , that we denote by \mathcal{G}_f .

Lemma 1.2.3 (Murray-Stevenson [MS00]). *Let $f : X \rightarrow Y$ be a morphism of surjective submersions over M , and let \mathcal{G} be a bundle gerbe with surjective submersion $\pi : Y \rightarrow M$. Then, the bundle gerbes \mathcal{G} and \mathcal{G}_f are stably isomorphic.*

Proof. We define a stable isomorphism in the following way: the line bundle A over $Z := X \times_M Y$ is the pullback of the line bundle L over $Y^{[2]}$ along the mixed map $f_1 : (x, y) \mapsto (f(x), y)$ which is well-defined since f preserves the fibres, $A := f_1^* L$. Now consider the isomorphism λ of line bundles over $Y^{[4]}$ used in the definition of the identity stable isomorphism $\text{id}_{\mathcal{G}}$. Its pullback $f_1^* \lambda$ gives the isomorphism α :

$$\alpha := f_1^* \lambda : p_1^* f^* L \otimes \zeta_2^* A \rightarrow \zeta_1^* A \otimes p_2^* L.$$

The axioms for the stable isomorphism defined by (A, α) can easily be identified as the pullbacks of the axioms of $\text{id}_{\mathcal{G}}$ along f_1 . ■

Now let \mathcal{G} be any bundle gerbe over M . Since its surjective submersion $\pi : Y \rightarrow M$ admits local sections, there exists an open cover \mathfrak{V} of M with smooth sections $s_i : V_i \rightarrow Y$. They define a smooth map $s : M_{\mathfrak{V}} \rightarrow Y$ that sends a point $x \in V_i$ to $s_i(x) \in Y$. Since s is moreover a morphism of surjective submersions, we have

Corollary 1.2.4. *Every bundle gerbe over M is stably isomorphic to a bundle gerbe whose surjective submersion comes from an open cover of M .*

Recall that in the previous section we have described how to obtain a cocycle from a bundle gerbe, whose surjective submersion comes from an open cover. Corollary 1.2.4 now tells us how to proceed for an arbitrary bundle gerbe.

Let us also extract local expressions for a stable isomorphism $\mathcal{A} : \mathcal{G} \rightarrow \mathcal{G}'$ of bundle gerbes, that is to relate cocycles for the two bundle gerbes \mathcal{G} and \mathcal{G}' . Without loss of generality we may assume that both bundle gerbes have the same surjective submersion $\pi : M_{\mathfrak{V}} \rightarrow M$, coming from an open cover \mathfrak{V} with contractible open sets and contractible two-fold intersections. Like explained above, the fibre product Z is the common refinement of the open cover \mathfrak{V} with itself, so that we have in particular an inclusion $\iota_i : V_i \hookrightarrow Z$ of any open set V_i into the component $V_i \cap V_i$ of Z .

Recall that we have chosen sections $\sigma_{ij} : V_i \cap V_j \rightarrow L$ and $\sigma'_{ij} : V_i \cap V_j \rightarrow L'$ by which we obtained local connection 1-forms A_{ij} and A'_{ij} of the line bundles, and smooth $U(1)$ -valued functions g_{ijk} and g'_{ijk} on three-fold intersections. Now consider the pullback $\iota_i^* A$ of the line bundle A of the stable isomorphism \mathcal{A} to a contractible open set V_i . We choose new sections $\sigma_i : V_i \rightarrow \iota_i^* A$ and obtain local connection 1-forms $W_i \in \Omega^1(V_i)$. Since the inclusions ι_i induce inclusions on two-fold intersections $\iota_{ij} : V_i \cap V_j \rightarrow Z^{[2]}$ we are able to pull back the isomorphism α of the stable isomorphism \mathcal{A} , whereby we obtain smooth functions $t_{ij} : V_i \cap V_j \rightarrow U(1)$ defined by

$$\iota_{ij}^* \alpha(\sigma_{ij} \otimes \sigma_j) = t_{ij} \cdot (\sigma_i \otimes \sigma'_{ij}).$$

We call the collection (t, W) a cochain for the stable isomorphism \mathcal{A} . Let us gather some conditions on this cochain using the axioms from Definition 1.2.1. We obtain:

$$\begin{aligned} t_{ik} \cdot g_{ijk} &= g'_{ijk} \cdot t_{ij} \cdot t_{jk} \\ A'_{ij} + W_i &= W_j + A_{ij} + \frac{1}{i} t_{ij}^{-1} dt_{ij} \\ dW_i &= B'_i - B_i. \end{aligned} \tag{1-4}$$

The first identity comes from axiom (SI2), the second from the fact that α preserves the connections, and the third follows directly from (SI1). So, a cochain for a stable isomorphism relates cocycles for the two bundle gerbes in a certain way.

Let us also find a local expression for a 2-isomorphism $\beta : \mathcal{A} \Rightarrow \mathcal{A}'$. We may have chosen sections $\sigma_i : V_i \rightarrow \iota_i^* A$ and $\sigma'_i : V_i \rightarrow \iota_i^* A'$ and extracted 1-forms W_i and W'_i , and smooth functions t_{ij} and t'_{ij} . It is clear that the isomorphism $\beta : A \rightarrow A'$ of line bundles over Z pulls back to V_i , so that it determines smooth functions $b_i : V_i \rightarrow \mathbb{U}(1)$ by

$$\iota_i^* \beta : \iota_i^* A \rightarrow \iota_i^* A'.$$

The compatibility of β with the isomorphisms α and α' , and the condition that β preserves connections leads to the following two conditions:

$$\begin{aligned} b_j \cdot t_{ij} &= t'_{ij} \cdot b_i \\ W'_i &= W_i + \frac{1}{i} b_i^{-1} db_i. \end{aligned} \tag{1-5}$$

We call the collection (b) of locally defined functions a cochain for the 2-isomorphism β . Again, a natural arrangement of all these cochains and conditions is provided by Deligne cohomology, and described in §1.3.

We are now able to relate cocycles for the tensor product $\mathcal{G} \otimes \mathcal{G}'$ of two bundle gerbes over M to cocycles for \mathcal{G} and \mathcal{G}' . If we choose an open cover \mathfrak{V} which is fine enough to admit local sections to both surjective submersions $\pi : Y \rightarrow M$ and $\pi' : Y' \rightarrow M$ of the two bundle gerbes involved, with a choice of sections $\sigma_{ij} : V_i \cap V_j \rightarrow L$ and $\sigma'_{ij} : V_i \cap V_j \rightarrow L'$ we may have obtained cocycles (g, A, B) for \mathcal{G} and (g', A', B') for \mathcal{G}' . We use the inclusion maps $\iota_i : V_i \rightarrow Z$ described above and obtain a morphism $\iota : M_{\mathfrak{V}} \rightarrow Z$ of surjective submersions. Applying Lemma 1.2.3 to this morphism s and the tensor product bundle gerbe $\mathcal{G} \otimes \mathcal{G}'$, we obtain a stably isomorphic bundle gerbe \mathcal{H} whose surjective submersion is again $M_{\mathfrak{V}} \rightarrow M$. By construction, the line bundle of the bundle gerbe \mathcal{H} is $\iota_{ij}^* L \otimes \iota_{ij}^* L'$ over $V_i \cap V_j$, so that we may use the sections $\sigma_{ij} \otimes \sigma'_{ij}$. This way we obtain the functions $g_{ijk} \cdot g'_{ijk}$, the 1-forms $A_{ij} + A'_{ij}$ and the 2-forms $B_i + B'_i$. Summarizing, the sum $(g \cdot g', A + A', B + B')$ is a cocycle for the tensor product $\mathcal{G} \otimes \mathcal{G}'$.

To close this section, let us discuss an important type of stable isomorphisms between bundle gerbes, that will be an essential tool for the definition of surface holonomy given in §1.5.

Definition 1.2.5. A trivialization of a bundle gerbe \mathcal{G} over M is a 2-form $\rho \in \Omega^2(M)$ and a stable isomorphism

$$\mathcal{T} : \mathcal{G} \rightarrow \mathcal{I}_\rho.$$

A bundle gerbe is called trivializable, if it admits a trivialization.

Let us briefly exhibit the details of a trivialization, which follow from the definition of a stable isomorphism and the one of the trivial bundle gerbe \mathcal{I}_ρ . The isomorphism \mathcal{T} consists of a line bundle T over the space $Z = Y \times_M M$

which we identify canonically with Y itself. Under this identification, the two projections p_1 and p_2 become the identity $\text{id} : Y \rightarrow Y$ and the surjective submersion $\pi : Y \rightarrow M$, respectively, so that axiom (SI1) is

$$\text{curv}(T) = \pi^* \rho - C. \quad (1-6)$$

We further have an isomorphism $\tau : L \otimes \pi_2^* T \rightarrow \pi_1^* T$ of line bundles over $Z^{[2]} = Y^{[2]}$. Because the multiplication of the trivial bundle gerbe \mathcal{I}_ρ is the identity, axiom (SI2) for τ reduces to the equation

$$\pi_{13}^* \tau \circ \mu = \pi_{12}^* \tau \circ \pi_{23}^* \tau$$

of isomorphisms of line bundles over $Z^{[3]} = Y^{[3]}$.

Remark 1.2.6. Often a trivialization is defined as a pair (T, τ) of a line bundle and an isomorphism τ with the compatibility condition with μ as above. One can then show that the 2-form $\text{curv}(T) + C$ descends along $\pi : Y \rightarrow M$ to a unique 2-form ρ on M . So, this definition gives exactly the same information as Definition 1.2.5. What we have gained here is the insight that a trivialization is nothing but a certain stable isomorphism.

Of course not every bundle gerbe admits a trivialization. We discuss the obstruction to find a trivialization in detail in §1.3. Note that, if a trivialization exists, the curvature of the bundle gerbe \mathcal{G} is an exact form, and

$$\text{curv}(\mathcal{G}) = d\rho$$

for any trivialization $\mathcal{T} : \mathcal{G} \rightarrow \mathcal{I}_\rho$. This follows from the derivative of equation (1-6). Notice, however, that the 2-form ρ is in general not unique.

1.3 Deligne Cohomology

In this section we describe the appropriate way to sort all local expressions for line bundles (i.e. hermitian line bundles with unitary connection) and bundle gerbes. In the first place, these local expressions are differential forms, so it is natural to consider the de Rham sheaf complex

$$\underline{\Omega}_M^0 \xrightarrow{d} \underline{\Omega}_M^1 \xrightarrow{d} \underline{\Omega}_M^2 \xrightarrow{d} \dots$$

where $\underline{\Omega}_M^k$ denotes the sheaf of (smooth) k -forms on M , and d is the exterior derivative. We make two modifications in this complex. First notice that no 0-forms appear in the local expressions of line bundles or bundle gerbes but only $\text{U}(1)$ -valued functions. To consider such functions in the context of the de Rham sheaf complex, we use the sheaf homomorphism

$$d\log : \underline{\text{U}(1)}_M \rightarrow \underline{\Omega}_M^1$$

which is defined for a smooth function $g : V \rightarrow \mathbb{U}(1)$ on an open subset V of M by

$$\mathrm{dlog}(g) := \frac{1}{i} g^* \theta \in \Omega^1(V),$$

where $\theta \in \Omega^1(\mathbb{U}(1), i\mathbb{R})$ is the left-invariant Maurer-Cartan form on $\mathbb{U}(1)$. Since $\mathrm{d}\theta = 0$ as a 2-form on $\mathbb{U}(1)$, it has the property $\mathrm{d} \circ \mathrm{dlog} = 0$. This allows us to replace the sheaf $\underline{\Omega}_M^0$ of 0-forms in the de Rham sheaf complex by the sheaf $\underline{\mathbb{U}(1)}_M$ of smooth $\mathbb{U}(1)$ -valued functions.

The second modification is motivated by the fact that the local connection 1-forms A_i of a line bundle, or, analogously, the local 2-forms B_i of a bundle gerbe are not closed unless the line bundle or the bundle gerbe is flat. So we have to truncate our complex at some degree n , whereby we are arrived at the sheaf complex

$$\underline{\mathbb{U}(1)}_M \xrightarrow{\mathrm{dlog}} \underline{\Omega}_M^1 \xrightarrow{\mathrm{d}} \underline{\Omega}_M^2 \xrightarrow{\mathrm{d}} \cdots \xrightarrow{\mathrm{d}} \underline{\Omega}_M^n$$

that is called the *Deligne complex in degree n* and that we denote by $\mathcal{D}^\bullet(n)$.

Definition 1.3.1. *The hypercohomology of the complex $\mathcal{D}^\bullet(n)$ is called Deligne cohomology in degree n , and its cohomology groups are denoted by $H^p(M, \mathcal{D}(n))$.*

Remark 1.3.2. Deligne cohomology sometimes refers to the hypercohomology of the following complex $\mathbb{Z}^\bullet(n)_{\mathcal{D}}^\infty$ of sheaves [Bry93]:

$$\mathbb{Z}_M \xrightarrow{i} \underline{\Omega}_M^0 \longrightarrow \underline{\Omega}_M^1 \longrightarrow \cdots \longrightarrow \underline{\Omega}_M^{n-1}.$$

This complex is quasi-isomorphic to our Deligne complex $\mathcal{D}^\bullet(n-1)$, so that the cohomology groups can be identified [Gom03].

We will not introduce sheaf cohomology, and use instead the description of the sheaf cohomology groups by Čech cohomology. This description is based on the fact that any sheaf \mathcal{A} of abelian groups over M has a resolution by the Čech cochain groups $\check{C}^k(\mathfrak{U}, \mathcal{A})$ for any open cover \mathfrak{U} of M . Applied to a complex \mathcal{K}^\bullet of sheaves like $\mathcal{D}^\bullet(n)$, this leads to a double complex $\check{C}^\bullet(\mathfrak{U}, \mathcal{K}^\bullet)$, which is in our example called the *Čech-Deligne double complex*, see Figure 1.1. Note that the squares of this double complex are commutative diagrams. The total cohomology of this double complex is the cohomology of a complex composed of diagonal sums

$$\mathrm{Tot}^k(\mathfrak{U}, \mathcal{K}) := \bigoplus_{k=p+q} \check{C}^p(\mathfrak{U}, \mathcal{K}^q)$$

and of a coboundary operator, which is in our example of $\mathcal{K}^\bullet = \mathcal{D}^\bullet(n)$ the *Deligne coboundary operator*

$$\begin{array}{ccccc}
\vdots & & \vdots & & \vdots \\
\uparrow \delta & & \uparrow \delta & & \uparrow \delta \\
\check{C}^1(\mathfrak{A}, \underline{U}(1)) & \xrightarrow{\text{dlog}} & \check{C}^1(\mathfrak{A}, \underline{\Omega}^1) & \xrightarrow{\text{d}} \dots \xrightarrow{\text{d}} & \check{C}^1(\mathfrak{A}, \underline{\Omega}^n) \\
\uparrow \delta & & \uparrow \delta & & \uparrow \delta \\
\check{C}^0(\mathfrak{A}, \underline{U}(1)) & \xrightarrow{\text{dlog}} & \check{C}^0(\mathfrak{A}, \underline{\Omega}^1) & \xrightarrow{\text{d}} \dots \xrightarrow{\text{d}} & \check{C}^0(\mathfrak{A}, \underline{\Omega}^n)
\end{array}$$

Figure 1.1: The Čech-Deligne double complex, where δ denotes the usual Čech coboundary operator.

$$D|_{\check{C}^p(\mathfrak{A}, \mathcal{D}^q(n))} := \begin{cases} \delta + (-1)^p \text{d} & \text{for } q > 0 \\ \delta + (-1)^p \text{dlog} & \text{for } q = 0. \end{cases}$$

The sign in this definition guarantees the complex condition $D \circ D = 0$. The total cohomology is denoted by $\check{H}^\bullet(\mathfrak{A}, \mathcal{K})$. By standard arguments in Čech cohomology, the cohomology groups $\check{H}^k(\mathfrak{A}, \mathcal{K})$ form a directed system over the directed set of open covers of M , whose direct limit is denoted by

$$\check{H}^k(M, \mathcal{K}) := \varinjlim_{\mathfrak{A}} \check{H}^k(\mathfrak{A}, \mathcal{K}) \tag{1-7}$$

and called the Čech cohomology of M with values in the sheaf complex \mathcal{K}^\bullet . It is often convenient to use a *good* open cover \mathfrak{A} , where all non-empty double intersections are contractible. In this case the canonical projection $\check{H}^k(\mathfrak{A}, \mathcal{K}) \rightarrow \check{H}^k(M, \mathcal{K})$ is an isomorphism, so that every element in $\check{H}^k(M, \mathcal{K})$ can be represented by a cocycle in the total complex $\text{Tot}^k(\check{C}^\bullet(\mathfrak{A}, \mathcal{K}^\bullet))$.

Lemma 1.3.3 (Godement [God58]). *For any complex of sheaves \mathcal{K}^\bullet , there exists natural group homomorphisms*

$$\check{H}^k(M, \mathcal{K}) \rightarrow H^k(M, \mathcal{K})$$

from the Čech cohomology to the sheaf hypercohomology. If M is paracompact, these homomorphisms are isomorphisms.

This lemma provides us with a hands on method to compute the sheaf hypercohomology $H^k(M, \mathcal{D}(n))$ of the Deligne complex. Let us exemplarily demonstrate this by finding a representative for Deligne cohomology classes in $H^k(M, \mathcal{D}(n))$ with $n = k$. We choose a good open cover \mathfrak{A} , so that by Lemma 1.3.3 and the remark above $H^k(M, \mathcal{D}(k)) \cong \check{H}^k(\mathfrak{A}, \mathcal{D}(k))$. Then, a class is represented by a cocycle

$$\alpha := (\alpha^0, \dots, \alpha^k) \in \text{Tot}^k(\mathfrak{A}, \mathcal{D}(k)),$$

where $\alpha^0 \in \check{C}^k(\mathfrak{V}, \underline{U}(1))$ is nothing but a family of smooth $U(1)$ -valued functions

$$\alpha_{i_0 \dots i_k}^0 : V_{i_0} \cap \dots \cap V_{i_k} \rightarrow U(1)$$

defined on each $(k+1)$ -fold intersection of open sets of \mathfrak{V} , and α^q , $q > 0$, is a family of q -forms $\alpha_{i_0 \dots i_{k-q}}^q \in \Omega^q(V_{i_0} \cap \dots \cap V_{i_{k-q}})$ defined on each $(k-q+1)$ -fold intersection. The coboundary of the cocycle α is

$$0 = D(\alpha) = (\delta\alpha^0, (-1)^k \text{dlog}(\alpha^0) + \delta\alpha^1, (-1)^{k-1} \text{d}\alpha^1 + \delta\alpha^2, \dots, -\text{d}\alpha^{k-1} + \delta\alpha^k).$$

Even more concrete, let us give examples for cocycles in the case $k = 1$. Let L be a line bundle over M – by which we still mean an hermitian line bundle with unitary connection according to Remark 1.1.1 – which is trivializable over \mathfrak{V} . Then, with a choice of section $s_i : V_i \rightarrow L$, its transition functions $g_{ij} : V_i \cap V_j \rightarrow U(1)$ and its local connection 1-forms $A_i \in \Omega^1(V_i)$ define a cocycle (g, A) , which now naturally becomes an element of $\text{Tot}^1(\mathfrak{V}, \mathcal{D}(1))$. The conditions (1–3) can be rewritten as

$$(\delta g)_{ijk} = 1 \quad \text{and} \quad -\text{dlog}(g_{ij}) + (\delta A)_{ij} = 0;$$

these are exactly the components of the cocycle condition $D(g, A) = 0$. Thus, cocycles for line bundles are cocycles in $\text{Tot}^1(\mathfrak{V}, \mathcal{D}(1))$. It is a nice exercise to check that its cohomology class

$$[(g, A)] \in H^1(M, \mathcal{D}(1))$$

depends neither on the choice of the open cover \mathfrak{V} nor of the choice of the sections $s_i : V_i \rightarrow L$, and depends only on the isomorphism class of L : concerning the choice of the open cover it suffices to discuss a refinement \mathfrak{U} of \mathfrak{V} , for which one may choose the restrictions of the sections s_i to the smaller open sets. This gives a cochain (g', A') which is the image of (g, A) under the induced map $\text{Tot}^1(\mathfrak{V}, \mathcal{D}(1)) \rightarrow \text{Tot}^1(\mathfrak{U}, \mathcal{D}(1))$, and thus defines the same class in the direct limit $H^1(M, \mathcal{D}(1))$. Furthermore, both a change of sections and an isomorphism $\varphi : L \rightarrow L'$ give rise to smooth functions $h_i : V_i \rightarrow U(1)$ on each open set. This defines an element $h \in \text{Tot}^0(\mathfrak{V}, \mathcal{D}(1))$ in such a way that the respective cocycles differ by the coboundary of h ,

$$(g', A') = (g, A) + D(h). \tag{1-8}$$

So we have a well-defined map from the set of isomorphism classes of line bundles over M to the Deligne cohomology group $H^1(M, \mathcal{D}(1))$. It is easy to see that this map is even a group homomorphism, with respect to the tensor product of line bundles.

Theorem 1.3.4 (Kostant [Kos70]). *The group homomorphism from the group of isomorphism classes of hermitian line bundles over M with unitary connection to the Deligne cohomology group $H^1(M, \mathcal{D}(1))$ is an isomorphism.*

Proof. Assume that cocycles (g', A') and (g, A) for two line bundles L and L' differ by the coboundary of a cochain h as in (1-8). Then one can construct an isomorphism $\varphi : L \rightarrow L'$ patched together from the functions $h_i : V_i \rightarrow \mathbb{U}(1)$. This proves that the group homomorphism is injective. The surjectivity is just the usual reconstruction procedure of a line bundle from given transition functions and local connection 1-forms. \blacksquare

Note that without the truncation of the Deligne complex in degree $n = 1$, the cocycle condition for a cocycle (g, A) would have a further component, namely $dA_i = 0$. Accordingly, the group isomorphism from Theorem 1.3.4 restricts to a group isomorphism from the group of isomorphism classes of flat line bundles to $H^1(M, \mathcal{D}(n))$ with $n > 1$. We will later prove that this group is isomorphic to $H^1(M, \mathbb{U}(1))$.

Next we are going to construct examples for the Deligne cohomology group $H^k(M, \mathcal{D}(k))$ for $k = 2$. Let \mathcal{G} be a bundle gerbe over M with surjective submersion $\pi : Y \rightarrow M$, let \mathfrak{V} be a good open cover which admits local sections $s_i : V_i \rightarrow Y$, and let $s : M_{\mathfrak{V}} \rightarrow Y$ be the corresponding morphism of surjective submersions. Recall that we have defined a bundle gerbe \mathcal{G}_s with surjective submersion $M_{\mathfrak{V}} \rightarrow M$, which is by Lemma 1.2.3 stably isomorphic to \mathcal{G} . As discussed in section 1.1, with a choice of sections $\sigma_{ij} : V_i \cap V_j \rightarrow s^*L$ we obtain smooth functions $g_{ijk} : V_i \cap V_j \cap V_k \rightarrow \mathbb{U}(1)$, 1-forms $A_{ij} \in \Omega^1(V_i \cap V_j)$ and 2-forms $B_i \in \Omega^2(V_i)$. The cocycle (g, A, B) for the bundle gerbe \mathcal{G} obtained like this is now naturally a cochain in $\text{Tot}^2(\mathfrak{V}, \mathcal{D}(2))$. If we rewrite the equations (1-2) as

$$(\delta g)_{ijkl} = 1 \quad , \quad \text{dlog}(g_{ijk}) + (\delta A)_{ijk} = 0 \quad \text{and} \quad -dA_{ij} + (\delta B)_{ij} = 0$$

they are nothing but the cocycle condition $D(g, A, B) = 0$. Thus, cocycles for bundle gerbes are cocycles in $\text{Tot}^2(\mathfrak{V}, \mathcal{D}(2))$. We will show in a minute that the class $[(g, A, B)] \in H^2(M, \mathcal{D}(2))$ of a cocycle depends neither on the choice of the open cover nor on the choice of the morphism s , nor on the choice of the sections σ_{ij} .

Before we do so, it is convenient to consider a stable isomorphism $\mathcal{A} : \mathcal{G} \rightarrow \mathcal{G}'$. We choose a good open cover \mathfrak{V} of M which admits sections in the surjective submersions of both bundle gerbes. We obtain two bundle gerbes \mathcal{G}_s and $\mathcal{G}'_{s'}$, and with the stable isomorphisms from Lemma 1.2.3, \mathcal{A} induces a stable isomorphism $\mathcal{G}_s \rightarrow \mathcal{G}'_{s'}$. As discussed in §1.2, with respect to choices σ_{ij} and σ'_{ij} as above, we have derived a cochain (t, W) for the stable isomorphism \mathcal{A} , which now appears as a cochain in $\text{Tot}^1(\mathfrak{V}, \mathcal{D}(2))$. It relates the cocycles (g, A, B) and (g', A', B') by equations (1-4), which we rewrite here as

$$g'_{ijk} \cdot g_{ijk}^{-1} = (\delta t)_{ijk} \quad , \quad A'_{ij} - A_{ij} = (\delta W)_{ij} - \text{dlog}(t_{ij}) \quad \text{and} \quad B'_i - B_i = dW_i,$$

or, equivalently, in short,

$$(g', A', B') = (g, A, B) + D(t, W).$$

So, the cocycles of stably isomorphic gerbes differ by a coboundary.

It is an easy exercise to calculate cochains for the three examples of stable isomorphisms we have introduced in the previous section. Since $(1, 0, \rho)$ is a cochain for the trivial bundle gerbe \mathcal{I}_ρ for any 2-form ρ on M , a cochain (t, W) for a trivialization $\mathcal{T} : \mathcal{G} \rightarrow \mathcal{I}_\rho$ satisfies

$$(1, 0, \rho) = (g, A, B) + D(t, W)$$

for any choice of a cocycle (g, A, B) for \mathcal{G} . Further, the trivial cochain $(1, 0)$ is a cochain for both the identity stable isomorphism $\text{id}_{\mathcal{G}}$,

$$(g, A, B) = (g, A, B) + D(1, 0),$$

and the duality stable isomorphism $\mathcal{D}_{\mathcal{G}}$, if one has chosen the cochain $(g^{-1}, -A, -B)$ for the dual bundle gerbe \mathcal{G}^* ,

$$(1, 0, 0) = ((g, A, B) + (g^{-1}, -A, -B)) + D(1, 0).$$

For completeness, let us also look at a 2-morphism between two stable isomorphisms $\mathcal{A} : \mathcal{G} \rightarrow \mathcal{G}'$ and $\mathcal{A}' : \mathcal{G} \rightarrow \mathcal{G}'$ both with cochains (t, W) and (t', W') respectively, satisfying the above condition. The isomorphism $\beta : A \rightarrow A'$ together with sections σ_i and σ'_i used to extract the cochains for \mathcal{A} and \mathcal{A}' , defines a cochain (b) , which is nothing but a cochain in $\text{Tot}^0(\mathfrak{A}, \mathcal{D}(2))$, and equations (1–5) assure

$$(t', W') = (t, W) + D(b).$$

Now we have interpreted cocycles for bundle gerbes, and cochains for 1- and 2-isomorphisms as elements in the total complex $\text{Tot}^k(\mathfrak{A}, \mathcal{D}(2))$.

Lemma 1.3.5. *The Deligne cohomology class $[(g, A, B)] \in H^2(M, \mathcal{D}(2))$ of a cocycle for a bundle gerbe \mathcal{G} is independent of all choices made. Furthermore, stably isomorphic bundle gerbes define the same class.*

Proof. For the choice of different open covers, we refer to the same argument given before the proof of Theorem 1.3.4. Let s and s' be different choices of morphisms $M_{\mathfrak{A}} \rightarrow Y$ of surjective submersions, leading to bundle gerbes \mathcal{G}_s and $\mathcal{G}_{s'}$. Since they are both stably isomorphic to \mathcal{G} , the associated cocycles differ by a coboundary as shown above. Finally, a choice of different sections σ'_{ij} defines smooth functions $t_{ij} : V_i \cap V_j \rightarrow \text{U}(1)$ with the property $g' = g \cdot \delta t$ and $A' - A = -\text{dlog}(t)$. This is a particular case of a cochain $(t, 0)$ by whose coboundary the two cocycles differ. \blacksquare

Summarizing, we have a well-defined map from the set of stable isomorphism classes of bundle gerbes over M to the Deligne cohomology group $H^2(M, \mathcal{D}(2))$. Recall that the set of stable isomorphism classes is even a group; now the discussion of local expressions for dual bundle gerbes and tensor products implies that the map to Deligne cohomology is a group homomorphism.

Theorem 1.3.6 (Murray-Stevenson [MS00]). *The group homomorphism*

$$\left\{ \begin{array}{l} \text{Stable isomorphism classes} \\ \text{of bundle gerbes over } M \end{array} \right\} \longrightarrow H^2(M, \mathcal{D}(2))$$

is an isomorphism.

Proof. To show the surjectivity, assume that $(g, A, B) \in \text{Tot}^2(\mathfrak{A}, \mathcal{D}(2))$ is a cocycle for some open cover \mathfrak{A} . We construct a bundle gerbe $\text{Con}(g, A, B)$ in the following way: let $Y := M_{\mathfrak{A}}$ be the disjoint union of the open sets of \mathfrak{A} , and let $\pi : Y \rightarrow M$ be the canonical projection. The curving is defined by $C|_{V_i} := B_i$. Consider the trivial hermitian line bundle L over $Y^{[2]}$, which we equip with a unitary connection using the 1-forms $A_{ij} \in \Omega^1(V_i \cap V_j)$. Finally, the cocycle g_{ijk} defines an associative isomorphism, which is the multiplication. Evidently, by choosing the trivial unit sections $\sigma_{ij}(x) = (x, 1)$, $x \in V_i \cap V_j$, we obtain exactly the cocycle (g, A, B) as a cocycle for the bundle gerbe $\text{Con}(g, A, B)$.

To prove the injectivity, assume that a bundle gerbe \mathcal{G} has vanishing Deligne class. So there exists an open cover \mathfrak{A} of M , a morphism $s : M_{\mathfrak{A}} \rightarrow Y$ of surjective submersions, by Lemma 1.2.3 a stably isomorphic bundle gerbe \mathcal{G}_s , together with sections $\sigma_{ij} : V_i \cap V_j \rightarrow L$ such that the corresponding cocycle (g, A, B) is a coboundary,

$$(g, A, B) = \text{D}(t, W). \quad (1-9)$$

We construct a trivialization $\mathcal{T}_{(t, W)} : \mathcal{G} \rightarrow \mathcal{I}_0$ as follows. The line bundle A over V_i is the trivial line bundle equipped with the connection 1-form W_i . It has the correct curvature, namely $\text{curv}(A)|_{V_i} = dW_i = B_i = C|_{V_i}$. We define the isomorphism

$$\alpha|_{V_i \cap V_j} : L|_{V_i \cap V_j} \otimes A|_{V_j} \rightarrow A|_{V_i} : (l, a) \mapsto (t_{ij}(l) \cdot a).$$

It respects the connections because of the second component of (1-9). Furthermore, it satisfies axiom (SI2) due to the third component. \blacksquare

Now that we have discovered the relation between Deligne cohomology and bundle gerbes, let us return to a general discussion of Deligne cohomology. From this discussion we will obtain important results for the theory of line bundles and bundle gerbes, using the two theorems above.

The Deligne complex has a natural projection to the sheaf $\underline{\mathbf{U}}(1)_M$, which is a chain map when we regard $\underline{\mathbf{U}}(1)_M$ as a trivial complex aside from degree 0. So it induces a homomorphism

$$\kappa : H^k(M, \mathcal{D}(n)) \rightarrow \check{H}^k(M, \underline{\mathbf{U}}(1)_M).$$

The exponential sequence

$$0 \longrightarrow \mathbb{Z}_M \longrightarrow \mathbb{R}_M \xrightarrow{\exp 2\pi i} \underline{\mathbf{U}}(1)_M \longrightarrow 0$$

Thus, (a) follows immediately, and for (b) it remains to calculate the image of the connecting homomorphism

$$\omega : H^{k-1}(M, \underline{U}(1)_M) \rightarrow \Omega^k(M)/d(\Omega^{k-1}(M)),$$

which indeed consists exactly of closed k -forms with integral class. \blacksquare

Similar to the chain map $\mathcal{D}^\bullet(n) \rightarrow \underline{U}(1)_M$ we have used before, we can regard the exterior derivative d as a chain map

$$\begin{array}{ccccccc} \underline{U}(1)_M & \xrightarrow{d \log} & \underline{\Omega}_M^1 & \xrightarrow{d} & \underline{\Omega}_M^2 & \xrightarrow{d} & \dots \xrightarrow{d} & \underline{\Omega}_M^k \\ & & & & & & & \downarrow d \\ & & & & & & & \underline{\Omega}_{\text{cl}, M}^{k+1} \end{array}$$

which induces a group homomorphism in cohomology,

$$d : H^k(M, \mathcal{D}(k)) \rightarrow \Omega_{\text{cl}}^{k+1}(M).$$

The two homomorphisms κ and d are related by the following

Proposition 1.3.8 (Brylinski [Bry93]). *Let $\alpha \in H^k(M, \mathcal{D}(k))$ be a Deligne cohomology class. The image of the class $\kappa(\alpha) \in H^{k+1}(M, \mathbb{Z})$ in real cohomology corresponds to the de Rham cohomology class $[d(\alpha)] \in H_{\text{dR}}^{k+1}(M)$ under the identification*

$$H^{k+1}(M, \mathbb{R}) \cong \check{H}^{k+1}(M, \mathbb{R}) \cong H_{\text{dR}}^{k+1}(M)$$

between singular cohomology, Čech cohomology and de Rham cohomology.

Proof. Let α be represented by a cochain $(\alpha_0, \dots, \alpha_k) \in \text{Tot}^k(\mathfrak{A}, \mathcal{D}(k))$, in particular $\alpha_0 \in \check{C}^k(\mathfrak{A}, \underline{U}(1)_M)$. The connecting homomorphism of the exponential sequence sends α_0 to the Čech cocycle $\delta \log(\alpha_0) \in \check{C}^{k+1}(\mathfrak{A}, \mathbb{R}_M)$ whose class is the image of $\kappa(\alpha)$ in $\check{H}^{k+1}(M, \mathbb{R})$. Now we recall that elements $[\beta_0]$ in Čech- and $[\beta_n]$ in de Rham cohomology correspond to each other, if and only if there exists a cochain (c_0, \dots, c_n) in the total complex $\text{Tot}^n(\check{C}^\bullet(\mathfrak{A}, \underline{\Omega}_M^\bullet))$ of the Čech-de Rham double complex whose total boundary is $(\delta c_0, \dots, dc_n) = (\beta_0, 0, \dots, 0, \beta_n)$. For $c_0 = \log(\alpha_0)$ and $c_i := \alpha_i$, this gives the correspondence between $\kappa(\alpha) = [\delta \log(\alpha_0)]$ and $[d\alpha]$. \blacksquare

To finish the general discussion of Deligne cohomology, consider the inclusion of the trivial complex which only consists of the sheaf $\underline{U}(1)_M$ of locally constant $\underline{U}(1)$ -valued functions on M and trivial groups else, into the Deligne sheaf complex,

$$\iota : \underline{U}(1)_M \hookrightarrow \mathcal{D}^\bullet(n).$$

Proposition 1.3.9. *The induced group homomorphism*

$$\iota^* : H^k(M, \mathbb{U}(1)) \rightarrow H^k(M, \mathcal{D}(n))$$

in cohomology has the following properties:

- (a) *for $0 \leq k < n$, it is an isomorphism.*
- (b) *for $k = n$, it fits into the exact sequence*

$$0 \longrightarrow H^k(M, \mathbb{U}(1)) \xrightarrow{\iota^*} H^k(M, \mathcal{D}(k)) \xrightarrow{d} \Omega_{\text{cl}, \mathbb{Z}}^{k+1}(M) \longrightarrow 0.$$

Proof. We use the same method as in the proof of Proposition 1.3.7, see [Gom03]. We denote by $\mathcal{D}_{\text{cl}}^\bullet(n)$ the Deligne complex in degree n but with $\mathcal{D}_{\text{cl}}^n(n) := \underline{\Omega}_{\text{cl}, M}^n$ only the closed n -forms instead of $\mathcal{D}^n(n) = \underline{\Omega}_M^n$. We have an obviously exact sequence

$$0 \longrightarrow \mathcal{D}_{\text{cl}}^\bullet(n) \longrightarrow \mathcal{D}^\bullet(n) \xrightarrow{d} \underline{\Omega}_{\text{cl}, M}^{n+1} \longrightarrow 0 \quad (1-10)$$

of sheaf complexes. By the Poincaré Lemma, it is easy to see that the inclusion ι defined above is a quasi-isomorphism $\iota : \mathbb{U}(1)_M \hookrightarrow \mathcal{D}_{\text{cl}}^\bullet(n)$, so that it induces isomorphisms $H^k(M, \mathbb{U}(1)) \cong H^k(M, \mathcal{D}_{\text{cl}}(n))$. Under this identification, the long exact sequence associated to the short exact sequence (1-10) proves both claims. \blacksquare

Let us now draw some consequences from the last three propositions on Deligne cohomology, first for the Deligne cohomology group $H^1(M, \mathcal{D}(1))$ which classifies line bundles. For a line bundle L over M and its Deligne class α , we identify the following geometric notions.

- (a) The class $\kappa(\alpha) \in H^2(M, \mathbb{Z})$ is the first Chern class of L , $\kappa(\alpha) = c_1(L)$; in particular, isomorphic line bundles have the same Chern class.
- (b) The 2-form $d(\alpha) \in \Omega^2(M)$ is the curvature of L , $d(\alpha) = \text{curv}(L)$; in particular, isomorphic line bundles have the same curvature.
- (c) The homomorphism $t^* : \Omega^1(M) \rightarrow H^1(M, \mathcal{D}(1))$ in the exact sequence from Proposition 1.3.7 can be represented by the assignment of the trivial line bundle $\mathbb{1}$ over M with the given 1-form as global connection 1-form.

With these identifications, it is easy to translate the assertions of the propositions into a geometric language, by which one can reproduce many familiar statements about line bundles.

Concerning bundle gerbes and Deligne cohomology, let \mathcal{G} be a bundle gerbe and let $\alpha \in H^2(M, \mathcal{D}(2))$ be the corresponding Deligne class. We call the characteristic class

$$dd(\mathcal{G}) := \kappa(\alpha) \in H^3(M, \mathbb{Z})$$

the *Dixmier-Douady class* of the bundle gerbe \mathcal{G} . An important impetus for the theory of gerbes was, that the Dixmier-Douady class provides geometric representatives for characteristic classes in degree three cohomology. We further reproduce the following geometric definitions:

- (a) The 3-form $d(\alpha) \in \Omega^3(M)$ is the curvature of \mathcal{G} , $d(\alpha) = \text{curv}(\mathcal{G})$; in particular, stably isomorphic bundle gerbes have the same curvature.
- (b) The homomorphism $t^* : \Omega^2(M) \rightarrow H^2(M, \mathcal{D}(1))$ in the exact sequence from Proposition 1.3.7 can be represented by the assignment of the trivial bundle gerbe \mathcal{I}_ρ over M for the given 2-form ρ .

Now we reformulate the statements of Propositions 1.3.7 b), 1.3.8 and 1.3.9 b) as follows.

Corollary 1.3.10. *Let M be a smooth manifold.*

- (i) *to every class $\alpha \in H^3(M, \mathbb{Z})$ there exists a bundle gerbe \mathcal{G} whose Dixmier-Douady class is $dd(\mathcal{G}) = \alpha$.*
- (ii) *a bundle gerbe is trivializable if and only if its Dixmier-Douady class vanishes.*
- (iii) *if $\mathcal{T}_1 : \mathcal{G} \rightarrow \mathcal{I}_{\rho_1}$ and $\mathcal{T}_2 : \mathcal{G} \rightarrow \mathcal{I}_{\rho_2}$ are two trivializations of the same bundle gerbe \mathcal{G} , the difference $\rho_2 - \rho_1$ is a closed 2-form with integral class.*
- (iv) *for any bundle gerbe \mathcal{G} over M , the de Rham cohomology class of the curvature $\text{curv}(\mathcal{G})$ corresponds to the image of the Dixmier-Douady class $dd(\mathcal{G})$ in real cohomology.*
- (v) *the set of stable isomorphism classes of bundle gerbes over M with fixed curvature is a torsor over the group $H^2(M, \mathbb{U}(1))$.*

In particular (iii) will prove to be essential for the definition of holonomy in §1.4. In §2.4 we will give an alternative proof of (iii) using the 2-categorical features.

To close this section, let us remark that we have seen that we gained a lot of information about bundle gerbes using the cohomological classification by Deligne cohomology. However, in some situations one appreciates the geometric nature of bundle gerbes, for example in the following section, where we construct examples of bundle gerbes.

1.4 Bundle Gerbes over Lie Groups

After we have introduced bundle gerbes as geometric objects over arbitrary manifolds, we now specialize to bundle gerbes over Lie groups. We describe in this section, how the Lie group structure allows constructions of examples of bundle gerbes, whose Dixmier-Douady classes realize the degree three cohomology of the Lie group. First constructions of gerbes over different types of compact Lie groups can be found in [Bry93, Cha98, Bry]. Bundle gerbes (with connection) have been constructed in [GR02, Mei02, GR03].

We consider a compact, simple (in particular connected) and simply-connected Lie group G . For the sake of completeness, let us recall the following well-known fact.

Theorem 1.4.1 (Cartan [Car36]). *Let G be a compact, simple and simply-connected Lie group. Then,*

$$\pi_2(G) = 0 \quad \text{and} \quad H_3(G) = \mathbb{Z},$$

where the second equation means a canonical isomorphism (not just up to sign).

We denote the generator of $H_3(G)$ corresponding to $1 \in \mathbb{Z}$ by γ . One can show that there exists a unique bi-invariant 3-form $\omega \in \Omega^3(G)$ such that $\int_\gamma \omega = 1$. This 3-form is called the *canonical 3-form* of the Lie group G . Since bi-invariant forms are always closed, ω is a closed 3-form with integral class.

To realize this canonical 3-form concretely, consider a symmetric Ad-invariant bilinear form $\langle -, - \rangle$ on the Lie algebra \mathfrak{g} of any compact simple Lie group G . We define the 3-form

$$\eta := \frac{1}{6} \langle \theta \wedge [\theta \wedge \theta] \rangle.$$

on G , where θ denotes the left invariant Maurer-Cartan form. The 3-form η is bi-invariant and hence closed.

Lemma 1.4.2 (Pressley-Segal [PS86]). *If G is compact, simple and simply-connected, and $\langle -, - \rangle$ is normalized such that $\langle \check{\alpha}, \check{\alpha} \rangle = 4\pi$ for each coroot $\check{\alpha}$ corresponding to a long root α , the canonical 3-form ω coincides with the 3-form η .*

Provided that the normalization condition of the above Lemma is satisfied, by Proposition 1.3.8 there exists over any compact, simple and simply-connected Lie group G a bundle gerbe \mathcal{G} with curvature $\text{curv}(\mathcal{G}) = \eta$. We also have $H^2(G, \text{U}(1)) = 0$, so that this bundle gerbe is unique up to stable isomorphism by Proposition 1.3.9. This unique bundle gerbe is called the *basic bundle gerbe*, and denoted by \mathcal{G}_0 . The bundle gerbes \mathcal{G}_k of curvature $k\eta$, $k \in \mathbb{Z}$ can then be obtained from \mathcal{G}_0 or \mathcal{G}_0^* by a k -fold tensor product. Bundle gerbes of curvature $k\eta$, not only over simply-connected but also over general compact simple Lie groups, play an important role in Wess-Zumino-Witten models, as we shall see in §1.6.

We restrict ourselves to the construction given in [GR02], from which we obtain the basic bundle gerbe \mathcal{G}_0 over the special unitary groups $\text{SU}(n)$ and the symplectic groups $\text{Sp}(2n)$, and only tensor products $\mathcal{G}_0^{k_0}$ for the other groups. First we consider a general compact, simple and simply-connected Lie group G with Lie algebra \mathfrak{g} . We choose a maximal torus T with Lie algebra \mathfrak{t} of rank r . We further choose a set of simple roots $\alpha_1, \dots, \alpha_r$ and denote the associated positive Weyl chamber by C . Let α_0 the highest root and let

$$\mathfrak{A} := \{\xi \in C \mid \alpha_0(\xi) \leq 1\}.$$

be the fundamental alcove. It is bounded by the hyperplanes H_i perpendicular to the roots α_i , and the additional hyperplane H_0 consisting of elements $\xi \in \mathfrak{t}$

with $\alpha_0(\xi) = 1$. So it is an r -dimensional simplex in \mathfrak{t} with vertices μ_0, \dots, μ_r determined by the condition that $\mu_i \in H_j$ for all $j \neq i$.

For simple and simply connected groups, the fundamental alcove parameterizes conjugacy classes of G in the sense that each conjugacy class contains a unique point $\exp \xi$ with $\xi \in \mathfrak{A}$. This defines a smooth map

$$q : G \rightarrow \mathfrak{A}.$$

Let \mathfrak{A}_i be the open complement of the face opposite to the vertex μ_i in \mathfrak{A} , and consider the open sets $V_i := q^{-1}(\mathfrak{A}_i)$. More generally, for any subset $I \subset \underline{r} = \{0, \dots, r\}$ we denote by V_I the intersection of all V_i with $i \in I$, and similarly by \mathfrak{A}_I the intersection of all \mathfrak{A}_i with $i \in I$. Of course $V_I = q^{-1}(\mathfrak{A}_I)$. We use the open sets V_i to construct a surjective submersion $\pi : Y \rightarrow G$ as usual. It is the first ingredient of the basic bundle gerbe we want to construct. To construct the line bundle L over $Y^{[2]}$ we show next that $Y^{[2]}$, the disjoint union of all two-fold intersections, projects onto a union of coadjoint orbits.

For any $I \subset \underline{r}$, all group elements $\exp \xi$ with ξ in the open face spanned by the vertices μ_i with $i \in I$ have the same centralizer G_I [Mei02]. For any inclusion $I \subset J$ it follows $G_J \subset G_I$; for $I = \underline{r}$ we obtain $G_{\underline{r}} = T$. Let S_I be the orbit of $\exp \mathfrak{A}_I \subset T$ under the conjugation with G_I . We consider the set $G \times_{G_I} S_I$ consisting of equivalence classes of pairs $(g, s) \in G \times S_I$ under the equivalence relation $(g, s) \sim (gh, h^{-1}sh)$ for $h \in G_I$. We have the canonical projection $\rho_I : G \times_{G_I} S_I \rightarrow G/G_I$ and a smooth map

$$u_I : G \times_{G_I} S_I \rightarrow V_I$$

which sends a representative (g, s) to $gsg^{-1} \in G$. This is well-defined on equivalence classes, and for $h \in G_I$ and $\xi \in \mathfrak{A}_I$ with $s := h \exp \xi h^{-1}$ we find $q(gsg^{-1}) = \xi$ and hence $gsg^{-1} \in V_I$. The map u_I is even a diffeomorphism: for $g \in V_I$ let $\xi := q(g) \in \mathfrak{A}_I$ and $h \in G$ such that $g = h \exp \xi h^{-1}$. Then, the inverse sends g to the equivalence class of $(h, \exp \xi)$.

Since G_{ij} fixes the difference $\mu_{ij} := \mu_j - \mu_i$, we can identify G/G_{ij} with the coadjoint orbit \mathcal{O}_{ij} of μ_{ij} in \mathfrak{g}^* . Now we specialize our construction to the case that μ_{ij} is a weight. This is the case for $SU(n)$ and $Sp(2n)$, where the vertices of the fundamental alcove are contained in the weight lattice. For μ_{ij} being a weight there is a canonical associated line bundle L_{ij} over the coadjoint orbit \mathcal{O}_{ij} . Let us recall the construction of this line bundle: if $\chi_{ij} : G_{ij} \rightarrow U(1)$ is the character associated to the weight μ_{ij} , it is the one-dimensional complex vector bundle associated to the principal G_{ij} -bundle G over G/G_{ij} in virtue of the character χ_{ij} , namely

$$L_{ij} := G \times_{G_{ij}} \mathbb{C}.$$

It inherits a hermitian metric from the standard metric on \mathbb{C} , and can also be equipped with a connection: we consider the 1-form $A_{ij} := \langle \mu_{ij}, \theta \rangle$ as a connection 1-form on the principal G_{ij} -bundle G . It induces a connection on

the associated line bundle L_{ij} because μ_{ij} is preserved under the action of G_{ij} . This way we have defined a hermitian line bundle with unitary connection. The curvature of this line bundle is the very symplectic form on the henceforth integral coadjoint orbit \mathcal{O}_{ij} .

The line bundles L_{ij} over \mathcal{O}_{ij} can be pulled back along

$$V_i \cap V_j \xrightarrow{\sim} G \times_{G_{ij}} S_{ij} \longrightarrow G/G_{ij} \xrightarrow{\sim} \mathcal{O}_{ij}$$

to line bundles over $V_i \cap V_j$, and their disjoint union gives a line bundle L over Y ^[2]. Now we define the multiplication of the basic bundle gerbe, i.e. an isomorphism

$$\mu : \pi_{12}^* L \otimes \pi_{23}^* L \rightarrow \pi_{13}^* L$$

of line bundles over Y ^[3]. Over the component $V_i \cap V_j \cap V_k$, this can be chosen as the pullback of the canonical identification

$$L_{ij} \otimes L_{jk} \cong L_{ik}$$

of line bundles over G/G_{ijk} , which comes from the coincidence $\mu_{ik} = \mu_{ij} + \mu_{jk}$ of the weights from which the line bundles are constructed. This identification is obviously associative, so that axiom (G2) is satisfied.

To finish the definition of the basic bundle gerbe, we define its curving, i.e. a 2-form $C \in \Omega^2(Y)$. We use the fact that the linear retraction r_i of \mathfrak{A}_i to the vertex μ_i lifts along the smooth map $q : G \rightarrow \mathfrak{A}$ to a smooth retraction \tilde{r}_i of V_i to the conjugacy class $\mathcal{C}_{\mu_i} := q^{-1}(\mu_i)$ [Mei02]:

$$\begin{array}{ccc} V_i \times [0, 1] & \xrightarrow{\tilde{r}_i} & V_i & \tilde{r}_i(-, 0) = \text{id}_{V_i} \text{ and } \tilde{r}_i(-, 1) = \mathcal{C}_{\mu_i} \\ q \times \text{id} \downarrow & & \downarrow q & \\ \mathfrak{A}_i \times [0, 1] & \xrightarrow{r_i} & \mathfrak{A}_i & r_i(-, 0) = \text{id}_{\mathfrak{A}_i} \text{ and } r_i(-, 1) = \mu_i \end{array}$$

Another well-known fact is that the 3-form η becomes exact when restricted to a conjugacy class

$$\iota_i^* \eta = d\omega_{\mu_i}, \quad (1-11)$$

where $\iota_i : \mathcal{C}_{\mu_i} \rightarrow G$ is the inclusion. A choice of the 2-form ω is for example the bi-invariant 2-form

$$\omega_{\mu_i} := \left\langle \iota_i^* \theta \wedge \frac{\text{Ad}_g^{-1} + \text{id}_{\mathfrak{g}}}{\text{Ad}_g^{-1} - \text{id}_{\mathfrak{g}}} \iota_i^* \theta \right\rangle \in \Omega^2(\mathcal{C}_{\mu_i}),$$

which also becomes important for the theory of D-branes and bi-branes in Chapter 3. Here, the homomorphism $\text{Ad}_g^{-1} - \text{id}_{\mathfrak{g}} : \mathfrak{g} \rightarrow \mathfrak{g}$ is invertible on the image of the restricted Maurer-Cartan form, and nominator and denominator commute.

Now the de Rham homotopy operator provides us with a 2-form C_i defined on V_i , for which equation (1–11) holds on the whole V_i rather than on the retract \mathcal{C}_{μ_i} . Namely, the pullback of ω_{μ_i} along the retraction \tilde{r}_i , followed by a fibre integration, yields a 2-form $C_i \in \Omega^2(V_i)$ with

$$\eta|_{V_i} = dC_i.$$

The particular choice of ω_{μ_i} above ensures $C_j - C_i = \langle \mu_{ij}, d\theta \rangle$ on $V_i \cap V_j$ [Mei02], which is axiom (SI1).

Summarizing, we have constructed a bundle gerbe over $SU(n)$ and $Sp(2n)$ with curvature η , thus the basic bundle gerbe. According to Lemma 1.4.2, its Dixmier-Douady class is $1 \in \mathbb{Z} = H^3(G, \mathbb{Z})$. For the other compact, simple and simply-connected Lie groups there exist integers k_0 for which the vertices of $k_0\mathfrak{A}$ lie in the weight lattice. Using the weights $k_0\mu_{ij}$ in the construction of the line bundles L_{ij} , and the 2-forms k_0C_i in the definition of the curving, we obtain bundle gerbes with curvature $k\eta$ with Dixmier-Douady classes $k_0 \in \mathbb{Z}$ [Mei02]. These are the powers $\mathcal{G}_0^{k_0}$ of the basic bundle gerbes over these groups. The smallest such integer k_0 is tabulated in [Bou68]:

G	$SU(n)$	$Spin(n)$	$Sp(2n)$	E_6	E_7	E_8	F_4	G_2
k_0	1	2	1	3	12	60	6	2

To construct the basic bundle gerbes on the groups with $k_0 > 1$ one has to use more advanced constructions [Mei02, GR03]. Here it becomes in particular important that the definition of a bundle gerbes admits $\pi : Y \rightarrow G$ to be a surjective submersion, which is more general than an open cover of G .

1.5 Surface Holonomy

Just as we have introduced bundle gerbes as categorified line bundles, surface holonomy of a bundle gerbe should generalize the holonomy of a line bundle around a loop. So, it is worthwhile to recall how the holonomy of a line bundle L (still understood as a hermitian line bundle with unitary connection according to Remark 1.1.1) over M around a loop $\gamma : S^1 \rightarrow M$ is defined.

The pullback of L along γ gives a line bundle over the circle, whose first Chern class vanishes for dimensional reasons. Hence, it becomes isomorphic to a trivial line bundle $\mathbb{1}_\omega$ with some connection 1-form $\omega \in \Omega^1(S^1)$ according to Proposition 1.3.7 b). Then,

$$\text{Hol}_L(\gamma) := \exp \left(2\pi i \int_{S^1} \omega \right)$$

is a number in $U(1)$ which is in fact independent of the choice of the trivialization: if ω' is another 1-form, also by Proposition 1.3.7 b) the difference $\omega' - \omega$ is closed and has integral class; hence, the difference of the integrals gives an integer, whose exponential vanishes.

We also write out this definition in terms of local expressions. Let $(g, A) \in \text{Tot}^1(\mathfrak{V}, \mathcal{D}(1))$ be a cocycle for the line bundle L with respect to an open cover $\mathfrak{V} = \{V_i\}_{i \in I}$. Note that a choice of a 1-form ω is related to this cocycle by

$$\gamma^*[(g, A)] = t^*(\omega) = [(1, \omega)] \tag{1-12}$$

We choose a triangulation Δ of S^1 that is subordinated to \mathfrak{V} by a map $i : \Delta \rightarrow I$ such that $\gamma(e) \subset V_{i(e)}$ for any edge $e \in \Delta$ and $\gamma(v) \in V_{i(v)}$ for any vertex $v \in \Delta$. Then, by splitting the integral over ω with respect to the triangulation, and using (1-12) and Stokes's Theorem, one can derive the formula

$$\text{Hol}_L(\gamma) = \prod_{e \in \Delta} \exp\left(2\pi i \int_e \gamma^* A_{i(e)}\right) \cdot \prod_{v \in \partial \Delta} g_{i(e)i(v)}^{\epsilon(e,v)}(\gamma(v))$$

where $\epsilon(e, v) \in \{-1, 1\}$ is positive, if v is the endpoint of e with respect to the orientation induced from S^1 , and negative otherwise.

Remark 1.5.1. The definition of holonomy of line bundles we have given here coincides with the one obtained by piecewise horizontal lifts of the curve ϕ , although this is not completely obvious. The coincidence is based on the fact that the exponential factors in the above local formula solve the very differential equations which determine the horizontal lifts, see [SWb].

For the definition of the surface holonomy of a bundle gerbe \mathcal{G} we start with a configuration like in Figure 1.2 and mimic the same procedure as for line

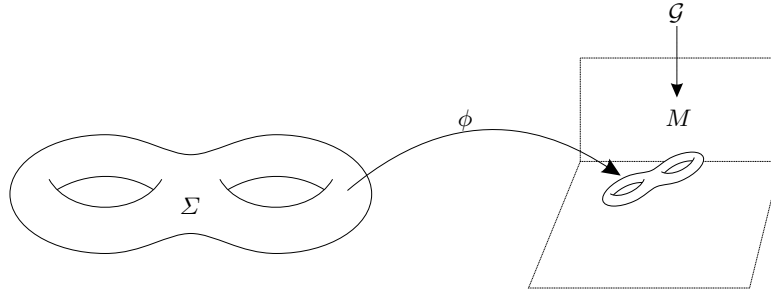

Figure 1.2: A closed surface is mapped into some space M with bundle gerbe \mathcal{G}

bundles. Since we have used that the circle is a closed and oriented manifold, we consider analogously closed and oriented surfaces.

Definition 1.5.2 (Carey-Johnson-Murray [CJM02]). *Let \mathcal{G} be a bundle gerbe over M . For a closed oriented surface Σ and a smooth map $\phi : \Sigma \rightarrow M$, let*

$$\mathcal{T} : \phi^* \mathcal{G} \rightarrow \mathcal{I}_\rho$$

be a trivialization of the pullback of the bundle gerbe \mathcal{G} along ϕ . Then we define

$$\text{Hol}_{\mathcal{G}}(\phi, \Sigma) := \exp \left(2\pi i \int_{\Sigma} \rho \right)$$

to be the oriented surface holonomy of the bundle gerbe \mathcal{G} around $\phi : \Sigma \rightarrow M$.

Notice that we have used the orientation on Σ . To show that oriented surface holonomy is well-defined, we use that Σ is closed: we have to assure that the number $\text{Hol}_{\mathcal{G}}(\phi, \Sigma)$ is independent of the choice of the trivialization, which – first of all – exists since the Dixmier-Douady class of the pullback bundle gerbe vanishes for dimensional reasons. Different trivializations may have different 2-forms ρ , however, by Corollary 1.3.10 the difference $\rho_2 - \rho_1$ between two such 2-forms is a closed form with integral class, whose integral over the closed surface Σ vanishes. Then, the calculation

$$\exp \left(2\pi i \int_{\Sigma} \rho_2 \right) = \exp \left(2\pi i \int_{\Sigma} \rho_2 - \rho_1 \right) \cdot \exp \left(2\pi i \int_{\Sigma} \rho_1 \right) = \exp \left(2\pi i \int_{\Sigma} \rho_1 \right)$$

shows that the definition $\text{Hol}_{\mathcal{G}}(\phi, \Sigma)$ is independent of the choice of the trivialization.

The following proposition collects several rather obvious properties of Definition 1.5.2.

Proposition 1.5.3. *Oriented surface holonomy of the gerbe \mathcal{G} has the following properties:*

- i) *it is invariant under orientation-preserving diffeomorphisms of Σ .*
- ii) *if $\bar{\Sigma}$ denotes the surface with the opposite orientation,*

$$\text{Hol}_{\mathcal{G}}(\phi, \Sigma) = \text{Hol}_{\mathcal{G}}(\phi, \bar{\Sigma})^{-1}.$$

- iii) *for a stable isomorphism $\mathcal{A} : \mathcal{G} \rightarrow \mathcal{G}'$, the holonomies $\text{Hol}_{\mathcal{G}}(\phi, \Sigma)$ and $\text{Hol}_{\mathcal{G}'}(\phi, \Sigma)$ coincide.*
- iv) *the holonomy of the dual gerbe \mathcal{G}^* is $\text{Hol}_{\mathcal{G}^*}(\phi, \Sigma) = \text{Hol}_{\mathcal{G}}(\phi, \Sigma)^{-1}$.*

Now we reformulate the holonomy in terms of local data of the bundle gerbe, analogous the formula for the holonomy of a line bundle. Recall that the trivialization $\mathcal{T} : \phi^* \mathcal{G} \rightarrow \mathcal{I}_\rho$ chosen in Definition 1.5.2 implies the relation

$$(1, 0, \rho) = \phi^*(g, A, B) + D(t, W)$$

between a cocycle for the bundle gerbe \mathcal{G} and the cocycle for the trivial gerbe, with respect to some open cover \mathfrak{U} . Now, following the strategy we have applied to obtain the local expression for the holonomy of a line bundle, we choose a triangulation Δ of the surface Σ , consisting of faces f , edges e and

vertices v . It should be chosen subordinated to the open cover $\mathfrak{V} = \{V_i\}_{i \in I}$ by means of a map $i : \Delta \rightarrow I$, assigning to each face, edge or vertex f an index $i(f)$ so that $\phi(f) \subset V_{i(f)}$. Now the integral of the 2-form ρ over Σ which defines the holonomy is decomposed with respect to the triangulation. By a subsequent use of Stokes's Theorem and the above formula for the local data, one ends up with the following formula, see [CJM02]:

$$\begin{aligned} \text{Hol}_{\mathcal{G}}(\phi, \Sigma) &= \prod_{f \in \Delta} \exp \left(\int_f \phi^* B_{i(f)} \right) \\ &\cdot \prod_{e \in \partial f} \exp \left(\int_e \phi^* A_{i(f), i(e)} \right) \cdot \prod_{v \in \partial e} g_{i(f), i(e), i(v)}^{\epsilon(f, e, v)}(\phi(v)). \quad (1-13) \end{aligned}$$

Here, $\epsilon(f, e, v)$ is positive if the vertex v is the endpoint of the edge v with respect to the orientation induced from the face f . Formula (1-13) shows explicitly what is going on: surface holonomy is the sum of local integrals over the 2-forms B_i and on the edges and vertices one has corrections by the rest of the cocycle for the bundle gerbe. This way, the triangulated surface gets decorated like shown in Figure 1.3.

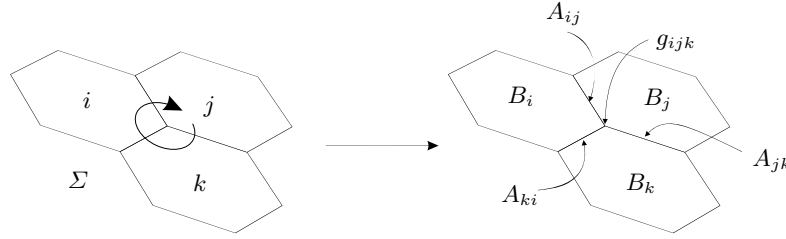

Figure 1.3: The triangulated surface Σ is decorated by local data of a bundle gerbe: the faces with 2-forms B_i , the edges with 1-forms A_{ij} and the vertices with the functions g_{ijk} .

Of course one can define the last expression without knowing bundle gerbes just by starting with a class in Deligne cohomology represented by a cocycle (g, A, B) . In fact, surface holonomy appeared first in this form [Alv85, Gaw88], and has then been interpreted geometrically [Bry93, CJM02].

We close this section with the following theorem that provides one of the facts which are important for the relation between bundle gerbes and Wess-Zumino terms.

Theorem 1.5.4 (Gawędzki [Gaw88]). *Let M be a smooth manifold, \mathcal{G} a bundle gerbe over M , and let B be a smooth oriented three-dimensional manifold with boundary, which is then a closed oriented surface ∂B . For any smooth map $\Phi : B \rightarrow M$,*

$$\mathrm{Hol}_{\mathcal{G}}(\Phi|_{\partial B}, \partial B) = \exp \left(2\pi i \int_B \Phi^* \mathrm{curv}(\mathcal{G}) \right).$$

Proof. We choose a triangulation Δ of B subordinated to an open cover $\mathfrak{U} = \{U_i\}_{i \in I}$ of B which admits a cocycle $(g, A, B) \in \mathrm{Tot}^2(\mathfrak{U}, \mathcal{D}(2))$ for $\Phi^* \mathcal{G}$. The triangulation consists of 3-faces V , 2-faces f , edges e and vertices v , and the subordinating map is denoted by $i : \Delta \rightarrow I$. Note that the triangulation Δ induces a triangulation of the boundary ∂B . Our aim is now to decompose the integral on the right hand side with respect to Δ , and to show that it (a) vanishes in the interior of B and (b) produces exactly the formula (1–13) on the boundary, which is the left hand side of the claimed equation.

The right hand side of the claimed equation is, using Stokes's Theorem and the third component of the cocycle condition $D(g, A, B) = 0$,

$$\sum_{V \in \Delta} \int_V dB_{i(V)} = \sum_{V \in \Delta} \sum_{f \in \partial V} \int_f B_{i(V)} = \sum_{V \in \Delta} \sum_{f \in \partial V} \int_f B_{i(f)} - dA_{i(V)i(f)}.$$

Every 2-face f appears twice in the sum but with opposite orientations, except those at the boundary. So from the first summand it remains only the first constituent of the local holonomy formula (1–13). The second summand gives, for a fixed 3-face V , by the second component of the cocycle condition,

$$\sum_{f \in \partial V} \sum_{e \in \partial f} \int_e A_{i(V)i(f)} = \sum_{f \in \partial V} \sum_{e \in \partial f} \int_e A_{i(V)i(e)} - A_{i(f)i(e)} + d \log g_{i(V)i(f)i(e)}.$$

Again, since every edge e appears twice but with different orientations, the first summand vanishes. The second summand vanishes in the interior of B by the same reason. On the boundary, it contributes the second constituent of the holonomy formula (1–13). Finally, the remaining terms are, using the first and last cocycle condition,

$$\prod_{f \in \partial V} \prod_{e \in \partial f} \prod_{p \in \partial e} g_{i(V)i(f)i(e)}^{\epsilon(V,f,e,p)} = \prod_{f \in \partial V} \prod_{e \in \partial f} \prod_{p \in \partial e} g_{i(f)i(e)i(p)}^{\epsilon(V,f,e,p)} \cdot g_{i(V)i(e)i(p)}^{-\epsilon(V,f,e,p)} \cdot g_{i(V)i(f)i(p)}^{\epsilon(V,f,e,p)}.$$

The second and the third factor again vanish since they appear twice with different exponents, and for the first factor the same argument as above applies. Summarizing, all terms have vanished except those on the boundary, where we have cooked up the local formula (1–13). \blacksquare

Note that we have now generalized Stokes's Theorem: let $H \in \Omega^3(M)$ be any 3-form on a three-dimensional manifold M with boundary, and assume

that H has integral class. Then there exists a bundle gerbe \mathcal{G} over M with $\text{curv}(\mathcal{G}) = H$. By Theorem 1.5.4 we have expressed the integral of H over M by the holonomy of \mathcal{G} around the boundary ∂M ,

$$\exp\left(2\pi i \int_M H\right) = \text{Hol}_{\mathcal{G}}(\partial M).$$

The original Stokes's Theorem in contrast can only be applied to exact forms. In particular, the above theorem can *not* be proven by Stokes's Theorem alone, as claimed in various proofs one finds in the literature.

1.6 Application: Sigma Models with Wess-Zumino Term

Let us first summarize Witten's original definition of the Wess-Zumino term from [Wit84] and put it in a more general context. We consider a 2-connected smooth manifold M , i.e. M is connected, simply-connected, and $\pi_2(M) = 0$, and a closed 3-form $H \in \Omega^3(M)$ with integral class. Now let Σ be a connected, oriented closed surface, and let $\phi : \Sigma \rightarrow M$ be a smooth map. Since Σ is two-dimensional and oriented, all its Stiefel-Whitney classes vanish, hence, by Thom's Theorem [Bre93] it is the boundary of a three-dimensional manifold B . Because M is 2-connected, there exists an extension of ϕ to B , i.e. a smooth map $\Phi : B \rightarrow M$ such that $\Phi|_{\Sigma} = \phi$. According to Witten, the Wess-Zumino term is given by

$$S_H^{\text{WZ}}(\Phi, B) = \int_B \Phi^* H.$$

Witten argues that, given other choices B' and Φ' , one can glue B and B' along its common boundary Σ to a closed three-dimensional manifold \tilde{B} , on which a map $\tilde{\Phi} : \tilde{B} \rightarrow M$ is defined componentwise by Φ and Φ' . Then, the difference between the Wess-Zumino terms $S_H^{\text{WZ}}(\Phi, B)$ and $S_H^{\text{WZ}}(\Phi', B')$ is the integral of H over \tilde{B} , that is, by the integrality condition on H , an integer. This way, the Wess-Zumino term is well-defined up to integers.

Now let \mathcal{G} be a bundle gerbe over M with curvature H . Such a bundle gerbe always exists by Corollary 1.3.10. Then, by Theorem 1.5.4,

$$\text{Hol}_{\mathcal{G}}(\phi, \Sigma) = \exp\left(2\pi i S_H^{\text{WZ}}(\Phi, B)\right).$$

This is the basic relation between the Wess-Zumino term and bundle gerbes, first discovered in [Gaw88]. It is fundamental for all applications of the theory of bundle gerbes to sigma models we discuss in this thesis.

Notice two important advantages of the holonomy term on the left hand side, compared to the Wess-Zumino term on the right hand side:

- 1.) it makes it unnecessary to choose three-dimensional manifolds and extensions.

2.) it is unambiguously defined for manifolds M with arbitrary topology.

Summarizing, we can give the following definition of a sigma model with Wess-Zumino term.

Definition 1.6.1. *A sigma model for oriented worldsheets is a smooth Riemannian manifold (M, g) together with a bundle gerbe \mathcal{G} . The Feynman amplitude of a smooth map $\phi : \Sigma \rightarrow M$, where Σ is a closed, oriented conformal surface, is the complex number*

$$\mathcal{A}_{g, \mathcal{G}}(\phi, \Sigma) := \exp(2\pi i S_g^{\text{kin}}(\phi, \Sigma)) \cdot \mathcal{A}_{\mathcal{G}}^{\text{WZ}}(\phi, \Sigma) \in \text{U}(1),$$

whose two constituents are given by

$$S_g^{\text{kin}}(\phi, \Sigma) := \frac{1}{2} \int_{\Sigma} g(d\phi \wedge \star d\phi) \quad \text{and} \quad \mathcal{A}_{\mathcal{G}}^{\text{WZ}}(\phi, \Sigma) := \text{Hol}_{\mathcal{G}}(\phi, \Sigma).$$

To introduce some terminology from physics, we call the manifold M of a sigma model the *target space*, and the metric g and the bundle gerbe \mathcal{G} the *B-fields*. $S_g^{\text{kin}}(\phi, \Sigma)$ is called the *kinetic term*, and the curvature

$$H := \text{curv}(\mathcal{G}) \in \Omega^3(M)$$

of the bundle gerbe \mathcal{G} is called the *field strength*.

To classify sigma models, we consider two sigma models with the same target space M and bundle gerbes \mathcal{G}_1 and \mathcal{G}_2 to be *gauge equivalent*, if there exists a stable isomorphism $\mathcal{G}_1 \rightarrow \mathcal{G}_2$. In this context, we call such a stable isomorphism a *gauge transformation*. Before we come to the advantages of the definition of the Wess-Zumino term via surface holonomy on a general manifold, let us rediscover Witten's situation.

Definition 1.6.2. *A sigma model is called topologically trivial, if its target space is 2-connected.*

We obtain the following classification of topologically trivial sigma models.

Proposition 1.6.3. *Gauge equivalence classes of topologically trivial sigma models are in bijection with triples (M, g, H) of a 2-connected Riemannian manifold (M, g) and a closed 3-form $H \in \Omega^3(M)$ with integral class.*

Proof. By Hurewicz's Theorem [BT82] for the simply-connected manifold M , the vanishing of $\pi_2(M)$ implies $H^2(M, \text{U}(1)) = 0$. By Corollary 1.3.10, there exists a bundle gerbe \mathcal{G} with curvature H . Furthermore, the set of stable isomorphism classes of bundle gerbes over M having this curvature are a torsor over the trivial group $H^2(M, \text{U}(1))$. So, \mathcal{G} is unique up to stable isomorphism. ■

Remark 1.6.4. For topologically trivial sigma models the B-field is, apart from the metric, a closed 3-form with integral class. Only if this class vanishes, the B-field may be viewed as a globally defined 2-form $B \in \Omega^2(M)$ with $dB = H$. Then, each two such 2-forms which differ by a closed 2-form define gauge equivalent sigma models.

For general sigma models, we have the following trivial, but important claim.

Theorem 1.6.5. *Gauge equivalence classes of sigma models for oriented worldsheets with target space M are in bijection with the Deligne cohomology group $H^2(M, \mathcal{D}(2))$.*

As we have indicated in the introduction, there are several motivations to consider sigma models whose target space is a Lie group G . A purely mathematical motivation the fact that there is a canonical family of topologically trivial sigma models. This comes from Theorem 1.4.1 saying that every compact, simple, simply-connected Lie group G is automatically 2-connected, and Lemma 1.4.2, that equips us with a canonical family of closed 3-forms $k\eta \in \Omega^3(G)$, $k \in \mathbb{Z}$, with integral class. This was exactly the setup Witten considered [Wit84]. At least for $G = \mathrm{SU}(n)$ and $G = \mathrm{Sp}(n)$, we have constructed bundle gerbes associated to these topologically trivial sigma models with field strength $H = k\eta$ in §1.4. These constructions realize the bijection of Proposition 1.6.3.

Now we come to general Lie groups, and capture the important properties of topologically trivial sigma models as follows.

Definition 1.6.6. *A Wess-Zumino-Witten model for oriented worldsheets is a sigma model for oriented worldsheets, whose target space is a Lie group G , whose metric g is given by a symmetric Ad-invariant bilinear form $\langle -, - \rangle$, and whose bundle gerbe \mathcal{G} has the curvature*

$$\mathrm{curv}(\mathcal{G}) = \frac{1}{6} \langle \theta \wedge [\theta \wedge \theta] \rangle.$$

If the Lie group G is compact and simple we can compare the pullback of the 3-form $\mathrm{curv}(\mathcal{G})$ to the simply-connected cover \tilde{G} with the canonical 3-form η we have on \tilde{G} . Their ratio is an integer $k \in \mathbb{Z}$, which is called the *level* of the Wess-Zumino-Witten model.

It is an interesting question to classify Wess-Zumino-Witten models with a fixed level k on a compact simple Lie group G . On the one hand, there may be obstructions on the level; the Lie group $\mathrm{SO}(3)$ for instance requires k to be even. This comes from the fact that the class of the 3-form on $\mathrm{SO}(3)$ whose pullback to its simply-connected cover $\mathrm{SU}(2)$ is $k\eta$ for k odd, is not integral. On the other hand, there may be several non-equivalent Wess-Zumino-Witten models with the same level, due to the fact that there exist non-isomorphic bundle gerbes with the same curvature; this occurs for instance on the Lie

group $\mathrm{SO}(4n)/\mathbb{Z}_2$. A complete classification of Wess-Zumino-Witten models on compact simple Lie groups has been derived in [GR03]. In §5.4 we recall some aspects of these derivations and give a complete list of Wess-Zumino-Witten models on compact simple Lie groups, see Table 5.1 on page 143.

The physical motivation to consider sigma models whose target space is a Lie group is Witten's claim that topologically trivial Wess-Zumino-Witten models lead to conformal (quantum) field theories [Wit84]. Later, it was argued in [GR02] that the curvature constraint from Definition 1.6.6 has to be imposed in the general case.

While the topologically trivial Wess-Zumino-Witten models are classified by their level $k \in \mathbb{Z}$, in general there may be non-stably isomorphic bundle gerbes having the same curvature, yielding non-gauge equivalent Wess-Zumino-Witten models with the same level. This is for example the case for the Lie group $G = \mathrm{SO}(n)/\mathbb{Z}_2$, which hosts two non-stably isomorphic bundle gerbes for each level $k \in \mathbb{Z}$, see also §5.4. Here, the theory of bundle gerbes explains precisely the well-established fact that to such a group *two* different conformal field theories can be associated that differ by „discrete torsion“. We explain in §5.4 that discrete torsion is nothing but the choice of different equivariant structures on a bundle gerbe.

Witten already observed two symmetries of the action functional of a topologically trivial Wess-Zumino-Witten model,

$$S_{g,H}^{\mathrm{WZW}}(\phi, \Sigma) := S_g^{\mathrm{kin}}(\phi, \Sigma) + S_H^{\mathrm{WZ}}(\Phi, B)$$

for some fixed choice of B and Φ as explained above. The first is translation symmetry: the action functional is invariant under the translations $\phi \mapsto l_h \circ \phi$ and $\phi \mapsto r_h \circ \phi$, where $l_h, r_h : G \rightarrow G$ denote the left and right multiplication by a group element $h \in G$; explicitly

$$S_{g,H}^{\mathrm{WZW}}(\phi, \Sigma) = S_{g,H}^{\mathrm{WZW}}(l_h \circ \phi, \Sigma) = S_{g,H}^{\mathrm{WZW}}(r_h \circ \phi, \Sigma).$$

The associated conserved Noether currents are given by

$$J_l(\phi, \Sigma) := -(1 + \star)\phi^*\theta \quad \text{and} \quad J_r(\phi, \Sigma) := (1 - \star)\phi^*\bar{\theta},$$

where $\bar{\theta}$ is the right invariant Maurer-Cartan form. The currents are closed 1-forms on Σ with values in the Lie algebra of G . They are also called *left* and *right mover*, due to their origin from left and right translation symmetry. To obtain these conserved currents, Witten derived a specific relative normalization of the kinetic and the Wess-Zumino term, which we have also adapted here implicitly.

The second symmetry Witten observed is the invariance of the action functional under a parity transformation: a flip of the orientation on Σ combined with an inversion on the group,

$$S_{g,H}^{\mathrm{WZW}}(\phi, \Sigma) = S_{g,H}^{\mathrm{WZW}}(\mathrm{Inv} \circ \phi, \bar{\Sigma}),$$

where $\bar{\Sigma}$ denotes the surface Σ with the reversed orientation, and $\text{Inv} : G \rightarrow G$ is the inversion $g \mapsto g^{-1}$. Amazingly, parity transformation exchanges the two conserved Noether currents of the translation symmetry:

$$J_l(\text{Inv} \circ \phi, \bar{\Sigma}) = J_r(\phi, \Sigma).$$

In other words, a parity transformation exchanges left and right movers.

It would be desirable to generalize both symmetries to topologically non-trivial Wess-Zumino-Witten models. A generalization of the translation symmetry would require G -bi-equivariant bundle gerbes, and the derivation of the conserved Noether currents would require a variational calculus for oriented surface holonomy of a bundle gerbe, which has not yet been studied.

For the purposes of this thesis, we restrict ourselves to a generalization of parity symmetry. First we consider a general Lie group G . It is a simple consequence of the properties of oriented surface holonomy of \mathcal{G} from Proposition 1.5.3, that the parity symmetry

$$\mathcal{A}_{g,\mathcal{G}}(\phi, \Sigma) = \mathcal{A}_{g,\mathcal{G}}(\text{Inv} \circ \phi, \bar{\Sigma}) \quad (1-14)$$

holds, if and only if the bundle gerbes $\text{Inv}^*\mathcal{G}$ and \mathcal{G}^* are stably isomorphic. Note that in general this is a constraint on the possible bundle gerbes \mathcal{G} , in contrast to topologically trivial Wess-Zumino-Witten models, where no condition is present:

Lemma 1.6.7. *If \mathcal{G} is the bundle gerbe of a topologically trivial Wess-Zumino-Witten model, the bundle gerbes $\text{Inv}^*\mathcal{G}$ and \mathcal{G}^* are stably isomorphic.*

Proof. The curvature of \mathcal{G} is fixed by Definition 1.6.6 to a 3-form H which evidently satisfies $\text{Inv}^*H = -H$. So, $\text{Inv}^*\mathcal{G}$ and \mathcal{G}^* have the same curvature, and since G is 2-connected, they have to be stably isomorphic. ■

We now give an even more general definition of parity symmetry, which also applies to sigma models with arbitrary target spaces.

Definition 1.6.8. *A parity transformation of a Riemannian manifold M with a bundle gerbe \mathcal{G} is an involutive isometry $k : M \rightarrow M$, such that the bundle gerbes $k^*\mathcal{G}$ and \mathcal{G}^* are stably isomorphic.*

It is clear that if $k : M \rightarrow M$ is a parity transformation of a sigma model (M, g, \mathcal{G}) , the parity symmetry

$$\mathcal{A}_{g,\mathcal{G}}(\phi, \Sigma) = \mathcal{A}_{g,\mathcal{G}}(k \circ \phi, \bar{\Sigma})$$

holds, generalizing (1-14). So it is clear that $\text{Inv} : G \rightarrow G$ is a parity transformation of a topologically trivial Wess-Zumino-Witten model. However, there are more parity transformations. Since the curvature of the bundle gerbe does not only satisfy $\text{Inv}^*H = -H$, but is also bi-invariant, by the same argument

as given in the proof of Lemma 1.6.7, the bundle gerbes \mathcal{G} , $l_h^*\mathcal{G}$ and $r_h^*\mathcal{G}$ are stably isomorphic for any group element $h \in G$. This motivates the ansatz $k(g) := h_l \cdot g^{-1} \cdot h_r$ for a more general parity transformation, and it is easy to check that the condition that k is involutive, i.e. $k^2 = \text{id}_G$, implies either $h_l = h_r$ or that both h_r and h_l are in the center of G . In the latter case, we have parity transformations

$$k : G \rightarrow G : g \mapsto z \cdot g^{-1}$$

for every element z in the center of G .

The observations about the parity symmetry of Wess-Zumino-Witten models and more general parity transformations will be fundamental for the discussion of sigma models for unoriented worldsheets we give in Chapter 4.

Chapter 2

Bundle Gerbes as a 2-Category

In the previous chapter we have introduced bundle gerbes and discussed their structure just as much as it was necessary to define oriented surface holonomy. For the purposes of the following chapters, namely to extend this notion of holonomy to more general types of surfaces, it will be essential to gain a deeper understanding of the structure bundle gerbes have.

From several perspectives it becomes clear that bundle gerbes are objects in a 2-category: from a bird's-eye, because gerbes appear as categorified line bundles, and from a worm's-eye view on the definitions of bundle gerbes and stable isomorphisms, which has already lead us in §1.3 to the observation that there are morphisms between stable isomorphisms. We present a new definition of this 2-category of bundle gerbes, and derive various new and important results concerning its properties. We also introduce several additional structures, that will be used frequently in the following chapters.

2.1 Morphisms between Bundle Gerbes revisited

In [Ste00] a 2-groupoid is defined, whose objects are bundle gerbes, and whose 1-morphisms are stable isomorphisms as we have defined them in Chapter 1. We recall that bundle gerbes have surjective submersions $\pi : Y \rightarrow M$, and that a stable isomorphism $\mathcal{A} : \mathcal{G}_1 \rightarrow \mathcal{G}_2$ between two bundle gerbes \mathcal{G}_1 and \mathcal{G}_2 with surjective submersions $\pi_1 : Y_1 \rightarrow M$ and $\pi_2 : Y_2 \rightarrow M$ consists of a certain line bundle A over the fibre product $Y_1 \times_M Y_2$. 2-isomorphisms between stable isomorphisms are isomorphisms $\beta : A \rightarrow A'$ of those line bundles, obeying a compatibility constraint. We have already mentioned that the composition of two stable isomorphisms $\mathcal{A} : \mathcal{G}_1 \rightarrow \mathcal{G}_2$ and $\mathcal{A}' : \mathcal{G}_2 \rightarrow \mathcal{G}_3$, and hence the transitivity of the equivalence relation „stably isomorphic“, is an involved issue: one has to define a line bundle \tilde{A} over $Y_1 \times_M Y_3$ using the line bundles A over $Y_1 \times_M Y_2$ and A' over $Y_2 \times_M Y_3$. In [Ste00] this problem is solved using descent theory for line bundles.

Here we describe a new method how to circumvent this descent theory, and how to add non-invertible morphisms at the same time; those play an important role in Chapter 3. We achieve this by introducing a generalized definition of stable isomorphisms, that we just call *1-morphism*.

We recall that according to Remark 1.1.1 we use the convention that line bundles are always hermitian line bundles with unitary connections. Now we extend this convention to vector bundles of higher rank: a *vector bundle* is a hermitian vector bundle with unitary connection, and *morphisms between vector bundles* are supposed to preserve the hermitian structure and the connection. The *curvature* of a vector bundle A over a smooth manifold M is a 2-form with values in the associated adjoint bundle, and we identify its trace with an ordinary 2-form $\text{tr}(\text{curv}(A)) \in \Omega^2(M)$.

Definition 2.1.1. A *1-morphism* $A : \mathcal{G}_1 \rightarrow \mathcal{G}_2$ between bundle gerbes \mathcal{G}_1 and \mathcal{G}_2 over M consists of a surjective submersion $\zeta : Z \rightarrow Y_1 \times_M Y_2$, a vector bundle A over Z and an isomorphism

$$\alpha : L_1 \otimes \zeta_2^* A \rightarrow \zeta_1^* A \otimes L_2 \quad (2-1)$$

of vector bundles over $Z \times_M Z$. This structure has to satisfy two axioms:

(1M1) The curvature of A obeys

$$\frac{1}{n} \text{tr}(\text{curv}(A)) = C_2 - C_1,$$

where n is the rank of the vector bundle A .

(1M2) The isomorphism α is compatible with the multiplication μ_1 and μ_2 of the gerbes \mathcal{G}_1 and \mathcal{G}_2 in the sense that the diagram

$$\begin{array}{ccc} \zeta_{12}^* L_1 \otimes \zeta_{23}^* L_1 \otimes \zeta_3^* A & \xrightarrow{\mu_1 \otimes \text{id}} & \zeta_{13}^* L_1 \otimes \zeta_3^* A \\ \text{id} \otimes \zeta_{23}^* \alpha \downarrow & & \downarrow \zeta_{13}^* \alpha \\ \zeta_{12}^* L_1 \otimes \zeta_2^* A \otimes \zeta_{23}^* L_2 & & \\ \zeta_{12}^* \alpha \otimes \text{id} \downarrow & & \downarrow \\ \zeta_1^* A \otimes \zeta_{12}^* L_2 \otimes \zeta_{23}^* L_2 & \xrightarrow{\text{id} \otimes \mu_2} & \zeta_1^* A \otimes \zeta_{13}^* L_2 \end{array}$$

of isomorphisms of vector bundles over $Z \times_M Z \times_M Z$ is commutative.

Additionally to the conventions concerning connections on vector bundles we just have used the simplifying convention, that we do not introduce notation for canonical projections such as $Z \rightarrow Y_1$ and $Z \rightarrow Y_2$ in the above definition; accordingly we do not write pullbacks along these maps. With this convention, the line bundles L_i in (2-1) are pulled back along the canonical

projections $Z^{[2]} \rightarrow Y_i^{[2]}$ for $i = 1, 2$. Axiom (1M1) is an equation of 2-forms on Z , where the curvings are pulled back along the canonical projections $Z \rightarrow Y_1$ and $Z \rightarrow Y_2$.

Notice that the stable isomorphisms from Definition 1.2.1 are particular examples of 1-morphisms, so that we really have generalized this definition. The generalization concerns two points: first, we admit vector bundles of higher rank than 1, and not just line bundles. They give rise to non-invertible 1-morphisms as to be discussed in §2.3. Second, these vector bundles are defined on the total space Z of a surjective submersion over the fibre product $P := Y_1 \times_M Y_2$ rather than on P itself. This generalization is to remove the difficulties with the composition of 1-morphisms, as we will see in §2.2.

Due to the generalization from stable isomorphisms to 1-morphisms, we have to give a new definition of 2-morphisms, which generalizes Definition 1.2.2. Let $\mathcal{A}_1 : \mathcal{G}_1 \rightarrow \mathcal{G}_2$ and $\mathcal{A}_2 : \mathcal{G}_1 \rightarrow \mathcal{G}_2$ be two 1-morphisms, coming with surjective submersions $\zeta_1 : Z_1 \rightarrow P$ and $\zeta_2 : Z_2 \rightarrow P$, where $P := Y_1 \times_M Y_2$. We consider triples

$$(W, \omega, \beta_W) \quad (2-2)$$

consisting of a smooth manifold W , a surjective submersion $\omega : W \rightarrow Z_1 \times_P Z_2$, and a morphism $\beta : A_1 \rightarrow A_2$ of vector bundles over W . Here we have according to our conventions suppressed notation for the pullbacks along the canonical projections $W \rightarrow Z_1$ and $W \rightarrow Z_2$. The triples (2-2) have to satisfy one axiom (2M): the morphism β has to be compatible with the isomorphisms α_1 and α_2 of the 1-morphisms \mathcal{A}_1 and \mathcal{A}_2 in the sense that the diagram

$$\begin{array}{ccc} L_1 \otimes \omega_2^* A_1 & \xrightarrow{\alpha_1} & \omega_1^* A_1 \otimes L_2 \\ 1 \otimes \omega_2^* \beta_W \downarrow & & \downarrow \omega_1^* \beta_W \otimes 1 \\ L_1 \otimes \omega_2^* A_2 & \xrightarrow{\alpha_2} & \omega_1^* A_2 \otimes L_2 \end{array}$$

of morphisms of vector bundles over $W \times_M W$ is commutative. This is the same condition we have imposed for the 2-isomorphisms in Definition 1.2.2. To get rid of the unessential choice of the manifold W , we impose an equivalence relation on the set of all triples (2-2) satisfying axiom (2M), according to that two triples (W, ω, β) and (W', ω', β') are equivalent, if there exists a smooth manifold X with surjective submersions to W and W' for which the diagram

$$\begin{array}{ccc} & X & \\ & \swarrow & \searrow \\ W & & W' \\ \omega \searrow & & \swarrow \omega' \\ & Z_1 \times_P Z_2 & \end{array} \quad (2-3)$$

of surjective submersions is commutative, and the morphisms β and β' coincide when pulled back to X .

Definition 2.1.2. A *2-morphism* $\mathcal{A}_1 \Rightarrow \mathcal{A}_2$ is an equivalence class of triples (W, ω, β) satisfying axiom (2M).

Now we start to prepare the definition of a 2-category whose objects are bundle gerbes. As pointed out in the outline of this thesis, a 2-category has Hom-categories instead of Hom-sets. In our case, the Hom-category $\mathfrak{Hom}(\mathcal{G}_1, \mathcal{G}_2)$ belonging to two bundle gerbes \mathcal{G}_1 and \mathcal{G}_2 has all 1-morphisms between \mathcal{G}_1 and \mathcal{G}_2 as its objects, and all 2-morphisms between those as its morphisms. In the remainder of this section, we define the identity morphisms and the composition of 2-morphisms, and show that the usual axioms of a category are satisfied. For this purpose, we need the following two technical lemmata.

An important consequence of the existence of the isomorphism μ in the structure of a bundle gerbe \mathcal{G} is that the line bundle L restricted to the image of the diagonal embedding $\Delta : Y \rightarrow Y^{[2]}$ is canonically trivializable (as a line bundle with connection):

Lemma 2.1.3. *There is a canonical isomorphism $t_\mu : \Delta^*L \rightarrow \mathbb{1}$ of line bundles over Y , which satisfies*

$$\pi_1^* t_\mu \otimes \text{id} = \Delta_{112}^* \mu \quad \text{and} \quad \text{id} \otimes \pi_2^* t_\mu = \Delta_{122}^* \mu$$

as isomorphisms of line bundles over $Y^{[2]}$, where $\Delta_{112} : Y^{[2]} \rightarrow Y^{[3]}$ duplicates the first and $\Delta_{122} : Y^{[2]} \rightarrow Y^{[3]}$ duplicates the second factor.

Proof. The isomorphism t_μ is defined using the canonical pairing with the dual line bundle L^* and the multiplication μ :

$$\Delta^*L = \Delta^*L \otimes \Delta^*L \otimes \Delta^*L^* \xrightarrow{\Delta^* \mu \otimes \text{id}} \Delta^*L \otimes \Delta^*L^* = \mathbb{1}$$

The two claimed equations follow from the associativity axiom (G2) by pullback along the maps Δ_{122} and Δ_{112} , both going from $Y^{[2]}$ to $Y^{[4]}$ in the obvious way. \blacksquare

The following lemma introduces an equally important isomorphism of vector bundles associated to every 1-morphism.

Lemma 2.1.4. *For any 1-morphism $\mathcal{A} : \mathcal{G}_1 \rightarrow \mathcal{G}_2$ there is a canonical isomorphism*

$$d_{\mathcal{A}} : \zeta_1^* \mathcal{A} \rightarrow \zeta_2^* \mathcal{A}$$

of vector bundles over $Z^{[2]} = Z \times_P Z$, where $P := Y_1 \times_M Y_2$, with the following properties:

a) *It satisfies the cocycle condition*

$$\zeta_{13}^* d_{\mathcal{A}} = \zeta_{23}^* d_{\mathcal{A}} \circ \zeta_{12}^* d_{\mathcal{A}}$$

as an equation of isomorphisms of vector bundles over $Z^{[3]}$.

b) *The diagram*

$$\begin{array}{ccc}
 L_1 \otimes \zeta_3^* A & \xrightarrow{\zeta_{13}^* \alpha} & \zeta_1^* A \otimes L_2 \\
 \text{id} \otimes \zeta_{34}^* d_{\mathcal{A}} \downarrow & & \downarrow \zeta_{12}^* d_{\mathcal{A}} \otimes \text{id} \\
 L_1 \otimes \zeta_4^* A & \xrightarrow{\zeta_{24}^* \alpha} & \zeta_2^* A \otimes L_2
 \end{array}$$

of isomorphisms of vector bundles over $Z^{[2]} \times_M Z^{[2]}$ is commutative.

Proof. Notice that the isomorphism α of \mathcal{A} restricted from $Z \times_M Z$ to $Z \times_P Z$ gives an isomorphism

$$\alpha|_{Z \times_P Z} : \Delta^* L_1 \otimes \zeta_2^* A \rightarrow \zeta_1^* A \otimes \Delta^* L_2.$$

By composition with the isomorphisms t_{μ_1} and t_{μ_2} from Lemma 2.1.3 we obtain the isomorphism $d_{\mathcal{A}}$:

$$\zeta_1^* A \xrightarrow{\text{id} \otimes t_{\mu_2}^{-1}} \zeta_1^* A \otimes \Delta^* L_2 \xrightarrow{\alpha|_{Z \times_P Z}^{-1}} \Delta^* L_1 \otimes \zeta_2^* A \xrightarrow{t_{\mu_1} \otimes \text{id}} \zeta_2^* A.$$

The cocycle condition a) and the commutativity of diagram b) follow both from axiom (1M2) for \mathcal{A} and the properties of the isomorphisms t_{μ_1} and t_{μ_2} from Lemma 2.1.3. \blacksquare

Now we are in the position to define the *identity 2-morphism* $\text{id}_{\mathcal{A}} : \mathcal{A} \rightrightarrows \mathcal{A}$ associated to every 1-morphism $\mathcal{A} : \mathcal{G}_1 \rightarrow \mathcal{G}_2$. It is defined as the equivalence class of the triple $(Z^{[2]}, \text{id}_{Z^{[2]}}, d_{\mathcal{A}})$ consisting of the fibre product $Z^{[2]} = Z \times_P Z$ itself, the identity $\text{id}_{Z^{[2]}}$ and the isomorphism $d_{\mathcal{A}} : \zeta_1^* A \rightarrow \zeta_2^* A$ of vector bundles over $Z^{[2]}$ from Lemma 2.1.4. Axiom (2M) for this triple is proven with Lemma 2.1.4 b).

Before we can prove that this 2-morphism is really an identity morphism in the category $\mathfrak{Hom}(\mathcal{G}_1, \mathcal{G}_2)$, we have to define the composition $\beta' \bullet \beta$ of two 2-morphisms $\beta : \mathcal{A}_1 \rightrightarrows \mathcal{A}_2$ and $\beta' : \mathcal{A}_2 \rightrightarrows \mathcal{A}_3$. To distinguish it from the composition of 1-morphisms we define later, the composition rule of the category $\mathfrak{Hom}(\mathcal{G}_1, \mathcal{G}_2)$ is called *vertical composition* in agreement with the diagrammatical notation

$$\begin{array}{ccc}
 & \mathcal{A}_1 & \\
 & \Downarrow \beta & \\
 \mathcal{G}_1 & \xrightarrow{\mathcal{A}_2} & \mathcal{G}_2 \\
 & \Downarrow \beta' & \\
 & \mathcal{A}_3 &
 \end{array}$$

We choose representatives (W, ω, β) and (W', ω', β') and consider the fibre product $\tilde{W} := W \times_{Z_2} W'$ with its canonical surjective submersion $\tilde{\omega} : \tilde{W} \rightarrow Z_1 \times_P Z_3$, where again $P := Y_1 \times_M Y_2$. By construction we can compose the pullbacks of the morphisms β and β' to \tilde{W} and obtain a morphism

$$\beta' \circ \beta : A_1 \rightarrow A_3$$

of vector bundles over \tilde{W} . From axiom (2M) for β and β' the one for the triple $(\tilde{W}, \tilde{\omega}, \beta' \circ \beta)$ follows. Furthermore, the equivalence class of this triple is independent of the choices of the representatives of β and β' . So we define this class to be the composed 2-morphism $\beta' \bullet \beta$. Clearly, the composition \bullet of the category $\mathfrak{Hom}(\mathcal{G}_1, \mathcal{G}_2)$ defined like this is associative.

It remains to check that the 2-isomorphism $\text{id}_{\mathcal{A}} : \mathcal{A} \Rightarrow \mathcal{A}$ defined above is the identity under the composition \bullet . Let $\beta : \mathcal{A} \Rightarrow \mathcal{A}'$ be a 2-morphism and (W, ω, β) a representative. The composite $\beta \bullet \text{id}_{\mathcal{A}}$ can be represented by the triple $(W', \omega', \beta \circ d_{\mathcal{A}})$ with $W' = Z \times_P W$, where $\omega' : W' \rightarrow Z \times_P Z'$ is the identity on the first factor and the projection $W \rightarrow Z'$ on the second one. We have to show, that this triple is equivalent to the original representative (W, ω, β) of β . To see this, consider the fibre product

$$X := W \times_{(Z \times_P Z')} W' \cong W \times_{Z'} W,$$

which satisfies condition (2-3). The restriction of the commutative diagram of morphisms of vector bundles over $W \times_M W$ from axiom (2M) for β to X gives rise to the commutative diagram

$$\begin{array}{ccc} \zeta_2^* A & \xrightarrow{d_{\mathcal{A}}^{-1}} & \zeta_1^* A \\ \omega_2^* \beta \downarrow & & \downarrow \omega_1^* \beta \\ A' & \xrightarrow{\Delta^* d_{\mathcal{A}'}^{-1}} & A' \end{array}$$

of morphisms of vector bundles over X , where $d_{\mathcal{A}}$ and $d_{\mathcal{A}'}$ are the isomorphisms determined by the 1-morphisms \mathcal{A} and \mathcal{A}' according to Lemma 2.1.4. Their cocycle condition from Lemma 2.1.4 a) implies $\Delta^* d_{\mathcal{A}'} = \text{id}_{A'}$, so that the last diagram reduces to the equality $\omega_2^* \beta \circ d_{\mathcal{A}} = \omega_1^* \beta$ of isomorphisms of vector bundles over X . This shows that the triples (W, ω, β) and $(W', \omega', \beta \circ d_{\mathcal{A}})$ are equivalent and we have $\beta \bullet \text{id}_{\mathcal{A}} = \beta$. The equality $\text{id}_{\mathcal{A}'} \bullet \beta = \beta$ follows analogously.

Now the definition of the Hom-category $\mathfrak{Hom}(\mathcal{G}_1, \mathcal{G}_2)$ is complete. A morphism in this category, i.e. a 2-morphism $\beta : \mathcal{A} \Rightarrow \mathcal{A}'$, is invertible if and only if the morphism $\beta : A \rightarrow A'$ of vector bundles in any representative (W, ω, β) of β is invertible. Since – following our convention – morphisms of vector bundles respect the hermitian structures, β is invertible if and only if the ranks of the vector bundles of the 1-morphisms \mathcal{A} and \mathcal{A}' coincide. In this case,

we also speak of a *2-isomorphism*. In the following, we call two 1-morphisms $\mathcal{A} : \mathcal{G}_1 \rightarrow \mathcal{G}_2$ and $\mathcal{A}' : \mathcal{G}_1 \rightarrow \mathcal{G}_2$ isomorphic, if there exists a 2-isomorphism $\beta : \mathcal{A} \Rightarrow \mathcal{A}'$ between them.

2.2 Composition of Morphisms

The goal of this section is the definition of the *composition functor* of the 2-category we are going to set up; this is a functor

$$\circ : \mathfrak{Hom}(\mathcal{G}_2, \mathcal{G}_3) \times \mathfrak{Hom}(\mathcal{G}_1, \mathcal{G}_2) \rightarrow \mathfrak{Hom}(\mathcal{G}_1, \mathcal{G}_3)$$

between the Hom-categories described in the previous section. Its following definition on objects (the 1-morphisms) shows immediately that our generalized 1-morphisms pay off.

Definition 2.2.1. *Let $\mathcal{A} : \mathcal{G}_1 \rightarrow \mathcal{G}_2$ and $\mathcal{A}' : \mathcal{G}_2 \rightarrow \mathcal{G}_3$ be two 1-morphisms. The composed 1-morphism*

$$\mathcal{A}' \circ \mathcal{A} : \mathcal{G}_1 \rightarrow \mathcal{G}_3$$

consists of the fibre product $\tilde{Z} := Z \times_{Y_2} Z'$ with its canonical surjective submersion $\tilde{\zeta} : \tilde{Z} \rightarrow Y_1 \times_M Y_3$, the vector bundle $\tilde{A} := A \otimes A'$ over \tilde{Z} , and the isomorphism

$$\tilde{\alpha} := (\text{id}_{\zeta_1^* A} \otimes \alpha') \circ (\alpha \otimes \text{id}_{\zeta_2'^* A'})$$

of vector bundles over $\tilde{Z} \times_M \tilde{Z}$.

Indeed, this defines a 1-morphism from \mathcal{G}_1 to \mathcal{G}_3 : we recall that if ∇_A and $\nabla_{A'}$ denote the connections on the vector bundles A and A' , the tensor product connection ∇ on $A \otimes A'$ is defined by

$$\nabla(\sigma \otimes \sigma') = \nabla_A(\sigma) \otimes \sigma' + \sigma \otimes \nabla_{A'}(\sigma')$$

for sections $\sigma \in \Gamma(A)$ and $\sigma' \in \Gamma(A')$. If we take n to be the rank of A and n' the rank of A' , the curvature of the tensor product vector bundle is

$$\text{curv}(A \otimes A') = \text{curv}(A) \otimes \text{id}_{n'} + \text{id}_n \otimes \text{curv}(A').$$

Hence its trace

$$\begin{aligned} \frac{1}{nn'} \text{tr}(\text{curv}(\tilde{A})) &= \frac{1}{n} \text{tr}(\text{curv}(A)) + \frac{1}{n'} \text{tr}(\text{curv}(A')) \\ &= C_2 - C_1 + C_3 - C_2 \\ &= C_3 - C_1 \end{aligned} \tag{2-4}$$

satisfies axiom (1M1). Notice that equation (2-4) involves unlabeled projections from \tilde{Z} to Y_1 , Y_2 and Y_3 , where the one to Y_2 is unique because \tilde{Z} is the fibre product over Y_2 . Furthermore, $\tilde{\alpha}$ is an isomorphism

$$\begin{aligned}
L_1 \otimes \tilde{\zeta}_2^* \tilde{A} &= L_1 \otimes \zeta_2^* A \otimes \zeta_2'^* A' \\
&\downarrow \alpha \otimes \text{id} \\
\zeta_1^* A \otimes L_2 \otimes \zeta_2'^* A' & \\
&\downarrow \text{id} \otimes \alpha' \\
\zeta_1^* A \otimes \zeta_1'^* A' \otimes L_3 &= \tilde{\zeta}_1^* \tilde{A} \otimes L_3.
\end{aligned}$$

Its axiom (1M2) follows from axioms (1M2) for \mathcal{A} and \mathcal{A}' .

Notice that even if the two 1-morphisms are stable isomorphisms, the result will not be a stable isomorphism but only a 1-morphism in the generalized sense.

Proposition 2.2.2. *The composition of 1-morphisms is strictly associative: for three 1-morphisms $\mathcal{A} : \mathcal{G}_1 \rightarrow \mathcal{G}_2$, $\mathcal{A}' : \mathcal{G}_2 \rightarrow \mathcal{G}_3$ and $\mathcal{A}'' : \mathcal{G}_3 \rightarrow \mathcal{G}_4$ we have*

$$(\mathcal{A}'' \circ \mathcal{A}') \circ \mathcal{A} = \mathcal{A}'' \circ (\mathcal{A}' \circ \mathcal{A}).$$

Proof. By definition, both 1-morphism $(\mathcal{A}'' \circ \mathcal{A}') \circ \mathcal{A}$ and $\mathcal{A}'' \circ (\mathcal{A}' \circ \mathcal{A})$ consist of the smooth manifold $X = Z \times_{Y_2} Z' \times_{Y_3} Z''$ with the same surjective submersion $X \rightarrow Y_1 \times_M Y_4$. On X , they have the same vector bundle $A \otimes A' \otimes A''$, and finally the same isomorphism

$$(\text{id} \otimes \text{id} \otimes \alpha'') \circ (\text{id} \otimes \alpha' \otimes \text{id}) \circ (\alpha \otimes \text{id} \otimes \text{id})$$

of vector bundles over $X \times_M X$. ■

Remark 2.2.3. The composition of 1-morphisms is only strict because we assumed strict fibre products of surjective submersions and strict tensor products of vector bundles. Without this simplification, there would be a non-trivial associator composed of the ones of these monoidal categories. However, the identifications $\mathcal{A} \circ \text{id}_{\mathcal{G}_1} \cong \mathcal{A}$ and $\text{id}_{\mathcal{G}_2} \circ \mathcal{A} \cong \mathcal{A}$ that we discuss in the next section, show a different behaviour: they are non-trivial even under the above strictness assumptions.

Let us continue with the definition of the functor \circ on morphisms of the Hom-categories (the 2-morphisms). Let $\mathcal{A}_1, \mathcal{A}'_1 : \mathcal{G}_1 \rightarrow \mathcal{G}_2$ and $\mathcal{A}_2, \mathcal{A}'_2 : \mathcal{G}_2 \rightarrow \mathcal{G}_3$ be 1-morphisms between bundle gerbes. The functor \circ on morphisms is called *horizontal composition* due to the diagrammatical notation

$$\begin{array}{ccc}
\mathcal{G}_1 & \begin{array}{c} \xrightarrow{\mathcal{A}_1} \\ \Downarrow \beta_1 \\ \xrightarrow{\mathcal{A}'_1} \end{array} & \mathcal{G}_2 & \begin{array}{c} \xrightarrow{\mathcal{A}_2} \\ \Downarrow \beta_2 \\ \xrightarrow{\mathcal{A}'_2} \end{array} & \mathcal{G}_3 & = & \mathcal{G}_1 & \begin{array}{c} \xrightarrow{\mathcal{A}_2 \circ \mathcal{A}_1} \\ \Downarrow \beta_2 \circ \beta_1 \\ \xrightarrow{\mathcal{A}'_2 \circ \mathcal{A}'_1} \end{array} & \mathcal{G}_3.
\end{array}$$

Recall that the compositions $\mathcal{A}_2 \circ \mathcal{A}_1$ and $\mathcal{A}'_2 \circ \mathcal{A}'_1$ consist of smooth manifolds $\tilde{Z} = Z_1 \times_{Y_2} Z_2$ and $\tilde{Z}' = Z'_1 \times_{Y_2} Z'_2$ with surjective submersions to $P := Y_1 \times_M Y_3$, of vector bundles $\tilde{A} := A_1 \otimes A_2$ over \tilde{Z} and $\tilde{A}' := A'_1 \otimes A'_2$ over \tilde{Z}' , and of isomorphisms $\tilde{\alpha}$ and $\tilde{\alpha}'$ over $\tilde{Z} \times_M \tilde{Z}$ and $\tilde{Z}' \times_M \tilde{Z}'$.

To define the composed 2-morphism $\beta_2 \circ \beta_1$, we first need a surjective submersion

$$\omega : W \rightarrow \tilde{Z} \times_P \tilde{Z}'.$$

We choose representatives (W_1, ω_1, β_1) and (W_2, ω_2, β_2) of the 2-morphisms β_1 and β_2 and define

$$W := \tilde{Z} \times_P (W_1 \times_{Y_2} W_2) \times_P \tilde{Z}' \quad (2-5)$$

with the surjective submersion $\omega := \tilde{z} \times \tilde{z}'$ projecting on the first and the last factor. Then, we need a morphism $\beta : \tilde{z}^* \tilde{A} \rightarrow \tilde{z}'^* \tilde{A}'$ of vector bundles over W . Notice that we have maps

$$u : W_1 \times_{Y_2} W_2 \rightarrow \tilde{Z} \quad \text{and} \quad u' : W_1 \times_{Y_2} W_2 \rightarrow \tilde{Z}'$$

such that we obtain surjective submersions

$$\tilde{z} \times u : W \rightarrow \tilde{Z}^{[2]} \quad \text{and} \quad u' \times \tilde{z}' : W \rightarrow \tilde{Z}'^{[2]}.$$

Recall from Lemma 2.1.4 that the 1-morphisms $\mathcal{A}_2 \circ \mathcal{A}_1$ and $\mathcal{A}'_2 \circ \mathcal{A}'_1$ define isomorphisms $d_{\mathcal{A}_2 \circ \mathcal{A}_1}$ and $d_{\mathcal{A}'_2 \circ \mathcal{A}'_1}$ of vector bundles over $\tilde{Z}^{[2]}$ and $\tilde{Z}'^{[2]}$, whose pullbacks to W along the above maps are isomorphisms

$$d_{\mathcal{A}_2 \circ \mathcal{A}_1} : \tilde{z}^* \tilde{A} \rightarrow u^* \tilde{A} \quad \text{and} \quad d_{\mathcal{A}'_2 \circ \mathcal{A}'_1} : u'^* \tilde{A}' \rightarrow \tilde{z}'^* \tilde{A}'$$

of vector bundles over W . Finally, the morphisms β_1 and β_2 give a morphism

$$\tilde{\beta} := \beta_1 \otimes \beta_2 : u^* \tilde{A} \rightarrow u'^* \tilde{A}'$$

of vector bundles over W so that the composition

$$\beta := d_{\mathcal{A}'_2 \circ \mathcal{A}'_1} \circ \tilde{\beta} \circ d_{\mathcal{A}_2 \circ \mathcal{A}_1} \quad (2-6)$$

is a well-defined morphism of vector bundles over W . Axiom (2M) for the triple (W, ω, β) follows from Lemma 2.1.4 b) for $\mathcal{A}_2 \circ \mathcal{A}_1$ and $\mathcal{A}'_2 \circ \mathcal{A}'_1$ and from the axioms (2M) for the representatives of β_1 and β_2 . Furthermore, the equivalence class of (W, ω, β) is independent of the choices of the representatives of β_1 and β_2 .

Lemma 2.2.4. *The assignment \circ defined above on objects and morphisms, is a functor*

$$\circ : \mathfrak{Hom}(\mathcal{G}_2, \mathcal{G}_3) \times \mathfrak{Hom}(\mathcal{G}_1, \mathcal{G}_2) \rightarrow \mathfrak{Hom}(\mathcal{G}_1, \mathcal{G}_3).$$

Proof. *i)* The assignment \circ respects identities, i.e. for 1-morphisms $\mathcal{A}_1 : \mathcal{G}_1 \rightarrow \mathcal{G}_2$ and $\mathcal{A}_2 : \mathcal{G}_2 \rightarrow \mathcal{G}_3$,

$$\text{id}_{\mathcal{A}_2} \circ \text{id}_{\mathcal{A}_1} = \text{id}_{\mathcal{A}_2 \circ \mathcal{A}_1}.$$

To show this we choose the defining representatives $(W_1, \text{id}, d_{\alpha_1})$ of $\text{id}_{\mathcal{A}_1}$ and $(W_2, \text{id}, d_{\alpha_2})$ of $\text{id}_{\mathcal{A}_2}$, where $W_1 = Z_1 \times_{(Y_1 \times_M Y_2)} Z_1$ and $W_2 = Z_2 \times_{(Y_2 \times_M Y_3)} Z_2$. Consider the diffeomorphism

$$f : W_1 \times_{Y_2} W_2 \rightarrow \tilde{Z} \times_{Y_1 \times_M Y_2 \times_M Y_3} \tilde{Z} : (z_1, z'_1, z_2, z'_2) \mapsto (z_1, z_2, z'_1, z'_2),$$

where $\tilde{Z} = Z_1 \times_{Y_2} Z_2$. From the definitions of the isomorphisms $d_{\mathcal{A}_1}$, $d_{\mathcal{A}_2}$ and $d_{\mathcal{A}_2 \circ \mathcal{A}_1}$ we conclude the equation $d_{\mathcal{A}_1} \otimes d_{\mathcal{A}_2} = f^* d_{\mathcal{A}_2 \circ \mathcal{A}_1}$ of isomorphisms of vector bundles over $W_1 \times_{Y_2} W_2$. The horizontal composition $\text{id}_{\mathcal{A}_2} \circ \text{id}_{\mathcal{A}_1}$ is canonically represented by the triple (W, ω, β_W) where W is defined in (2–5) and β_W is defined in (2–6). Now, the diffeomorphism f extends to an embedding $f : W \rightarrow \tilde{Z}^{[4]}$ into the four-fold fibre product of \tilde{Z} over $P = Y_1 \times_M Y_3$, such that $\omega : W \rightarrow \tilde{Z}^{[2]}$ factorizes over f ,

$$\omega = \tilde{\zeta}_{14} \circ f. \quad (2-7)$$

From the definitions we obtain

$$\begin{aligned} \beta_W &= d_{\mathcal{A}_2 \circ \mathcal{A}_1} \circ (d_{\mathcal{A}_1} \otimes d_{\mathcal{A}_2}) \circ d_{\mathcal{A}_2 \circ \mathcal{A}_1} \\ &= f^* (\tilde{\zeta}_{34}^* d_{\mathcal{A}_2 \circ \mathcal{A}_1} \circ \tilde{\zeta}_{23}^* d_{\mathcal{A}_2 \circ \mathcal{A}_1} \circ \tilde{\zeta}_{12}^* d_{\mathcal{A}_2 \circ \mathcal{A}_1}). \end{aligned}$$

The cocycle condition for $d_{\mathcal{A}_2 \circ \mathcal{A}_1}$ from Lemma 2.1.4 a) and (2–7) together give

$$\beta_W = f^* \tilde{\zeta}_{14}^* d_{\mathcal{A}_2 \circ \mathcal{A}_1} = \omega^* d_{\mathcal{A}_2 \circ \mathcal{A}_1}. \quad (2-8)$$

We had to show that the triple (W, ω, β_W) which represents $\text{id}_{\mathcal{A}_2} \circ \text{id}_{\mathcal{A}_1}$ is equivalent to the triple $(\tilde{Z}^{[2]}, \text{id}, d_{\mathcal{A}_2 \circ \mathcal{A}_1})$ which defines the identity 2-morphism $\text{id}_{\mathcal{A}_2 \circ \mathcal{A}_1}$. For the choice $X := W$ with surjective submersions $\text{id} : X \rightarrow W$ and $\omega : X \rightarrow \tilde{Z}^{[2]}$, equation (2–8) shows exactly this equivalence.

ii) The assignment \circ respects the composition \bullet , i.e. for 2-morphisms $\beta_i : \mathcal{A}_i \Rightarrow \mathcal{A}'_i$ and $\beta'_i : \mathcal{A}'_i \Rightarrow \mathcal{A}''_i$ between 1-morphisms \mathcal{A}_i , \mathcal{A}'_i and \mathcal{A}''_i from \mathcal{G}_i to \mathcal{G}_{i+1} , everything for $i = 1, 2$, we have an equality

$$(\beta'_2 \bullet \beta_2) \circ (\beta'_1 \bullet \beta_1) = (\beta'_2 \circ \beta'_1) \bullet (\beta_2 \circ \beta_1) \quad (2-9)$$

of 2-morphisms from $\mathcal{A}_2 \circ \mathcal{A}_1$ to $\mathcal{A}''_2 \circ \mathcal{A}''_1$. This equality is also known as the compatibility of vertical and horizontal compositions. To prove it, let us introduce the notation $\tilde{Z} := Z_1 \times_{Y_2} Z_2$, and analogously \tilde{Z}' and \tilde{Z}'' , furthermore we write $P := Y_1 \times_M Y_3$. Notice that the 2-morphism on the left hand side of (2–9) is represented by a triple (V, ν, β_V) with

$$V = \tilde{Z} \times_P (\tilde{W}_1 \times_{Y_2} \tilde{W}_2) \times_P \tilde{Z}'',$$

where the fibre products $\tilde{W}_i := W_i \times_{Z_i} W'_i$ arise from the vertical compositions $\beta'_i \bullet \beta_i$. The surjective submersion $\nu : V \rightarrow \tilde{Z} \times_P \tilde{Z}''$ is the projection on the first and the last factor, and

$$\beta_V = d_{\mathcal{A}'_2 \circ \mathcal{A}'_1} \circ ((\beta'_1 \circ \beta_1) \otimes (\beta'_2 \circ \beta_2)) \circ d_{\mathcal{A}_2 \circ \mathcal{A}_1}$$

is a morphism of vector bundles over V . The 2-morphism on the right hand side of (2–9) is represented by the triple $(V', \nu', \beta_{V'})$ with

$$\begin{aligned} V' &= (\tilde{Z} \times_P (W_1 \times_{Y_2} W_2) \times_P \tilde{Z}') \times_{\tilde{Z}'} (\tilde{Z}' \times_P (W'_1 \times_{Y_2} W'_2) \times_P \tilde{Z}'') \\ &\cong \tilde{Z} \times_P (W_1 \times_{Y_2} W_2) \times_P \tilde{Z}' \times_P (W'_1 \times_{Y_2} W'_2) \times_P \tilde{Z}'', \end{aligned}$$

where ν' is again the projection on the outer factors, and

$$\beta_{V'} = d_{\mathcal{A}'_2 \circ \mathcal{A}'_1} \circ (\beta'_1 \otimes \beta'_2) \circ d_{\mathcal{A}'_2 \circ \mathcal{A}'_1} \circ (\beta_1 \otimes \beta_2) \circ d_{\mathcal{A}_2 \circ \mathcal{A}_1},$$

where we have used the cocycle condition for $d_{\mathcal{A}'_2 \circ \mathcal{A}'_1}$ from Lemma 2.1.4 b).

We have to show that the triples (V, ν, β_V) and $(V', \nu', \beta_{V'})$ are equivalent. Consider the fibre product

$$X := V \times_{\tilde{Z} \times_P \tilde{Z}''} V'$$

with surjective submersions $v : X \rightarrow V$ and $v' : X \rightarrow V'$. To show the equivalence of the two triples, we have to prove the equality

$$v^* \beta_V = v'^* \beta_{V'}.$$

It is equivalent to the commutativity of the outer shape of the following diagram of isomorphisms of vector bundles over X :

$$\begin{array}{ccc} & A_1 \otimes A_2 & \\ \swarrow d_{\mathcal{A}_2 \circ \mathcal{A}_1} & & \searrow d_{\mathcal{A}_2 \circ \mathcal{A}_1} \\ v^*(A_1 \otimes A_2) & \xrightarrow{d_{\mathcal{A}_2 \circ \mathcal{A}_1}} & v'^*(A_1 \otimes A_2) \\ \downarrow \beta_1 \otimes \beta_2 & & \downarrow \beta_1 \otimes \beta_2 \\ v^*(A'_1 \otimes A'_2) & \xrightarrow{d_{\mathcal{A}'_2 \circ \mathcal{A}'_1}} & v'^*(A'_1 \otimes A'_2) \\ \downarrow \beta'_1 \otimes \beta'_2 & \swarrow d_{\mathcal{A}'_2 \circ \mathcal{A}'_1} \quad \searrow d_{\mathcal{A}'_2 \circ \mathcal{A}'_1} & \downarrow d_{\mathcal{A}'_2 \circ \mathcal{A}'_1} \\ v^*(A''_1 \otimes A''_2) & \xrightarrow{d_{\mathcal{A}''_2 \circ \mathcal{A}''_1}} & v'^*(A''_1 \otimes A''_2) \\ & \swarrow d_{\mathcal{A}''_2 \circ \mathcal{A}''_1} \quad \searrow d_{\mathcal{A}''_2 \circ \mathcal{A}''_1} & \\ & A''_1 \otimes A''_2 & \end{array}$$

The commutativity of the outer shape of this diagram follows from the commutativity of its five subdiagrams: the triangular ones are commutative due to the cocycle condition from Lemma 2.1.4 a), and the commutativity of the foursquare ones follows from axiom (2M) of the 2-morphisms. ■

We have now completed the definition of the composition functor, whereby we now have important ingredients of a 2-category at hand: the objects, the Hom-categories and the composition functor.

2.3 The 2-Category of Bundle Gerbes

We do not introduce the general definition of a 2-category, but only summarize the structure and axioms of the 2-category $\mathfrak{BGrb}(M)$ of bundle gerbes over a smooth manifold M : it consists of

1. A class of objects – bundle gerbes over M .
2. A Hom-category $\mathfrak{Hom}(\mathcal{G}, \mathcal{H})$ for each pair \mathcal{G}, \mathcal{H} of bundle gerbes, whose objects are called 1-morphisms and whose morphisms are called 2-morphisms.
3. A composition functor

$$\circ : \mathfrak{Hom}(\mathcal{H}, \mathcal{K}) \times \mathfrak{Hom}(\mathcal{G}, \mathcal{H}) \rightarrow \mathfrak{Hom}(\mathcal{G}, \mathcal{K})$$

for each triple $\mathcal{G}, \mathcal{H}, \mathcal{K}$ of bundle gerbes.

4. An identity 1-morphism $\text{id}_{\mathcal{G}} : \mathcal{G} \rightarrow \mathcal{G}$ for each bundle gerbe \mathcal{G} together with natural 2-isomorphisms

$$\rho_{\mathcal{A}} : \text{id}_{\mathcal{H}} \circ \mathcal{A} \Longrightarrow \mathcal{A} \quad \text{and} \quad \lambda_{\mathcal{A}} : \mathcal{A} \circ \text{id}_{\mathcal{G}} \Longrightarrow \mathcal{A}$$

associated to every 1-morphism $\mathcal{A} : \mathcal{G} \rightarrow \mathcal{H}$.

This structure has to satisfy the axioms of a strictly associative 2-category:

- (2C1) For three 1-morphisms $\mathcal{A} : \mathcal{G}_1 \rightarrow \mathcal{G}_2$, $\mathcal{A}' : \mathcal{G}_2 \rightarrow \mathcal{G}_3$ and $\mathcal{A}'' : \mathcal{G}_3 \rightarrow \mathcal{G}_4$, the composition functor satisfies

$$\mathcal{A}'' \circ (\mathcal{A}' \circ \mathcal{A}) = (\mathcal{A}'' \circ \mathcal{A}') \circ \mathcal{A}.$$

- (2C2) For 1-morphisms $\mathcal{A} : \mathcal{G}_1 \rightarrow \mathcal{G}_2$ and $\mathcal{A}' : \mathcal{G}_2 \rightarrow \mathcal{G}_3$, the 2-isomorphisms $\lambda_{\mathcal{A}}$ and $\rho_{\mathcal{A}}$ satisfy the equality

$$\text{id}_{\mathcal{A}'} \circ \rho_{\mathcal{A}} = \lambda_{\mathcal{A}'} \circ \text{id}_{\mathcal{A}}$$

as 2-morphisms from $\mathcal{A}' \circ \text{id}_{\mathcal{G}_2} \circ \mathcal{A}$ to $\mathcal{A}' \circ \mathcal{A}$.

We collect from §1.1 the definition of a bundle gerbe, from §2.1 the definition of the Hom-category $\mathfrak{Hom}(\mathcal{G}, \mathcal{H})$ and from §2.2 the one of the composition functor. Furthermore, we have already shown that axiom (2C1) is satisfied.

To finish the definition of the 2-category $\mathfrak{BGrb}(M)$ we have to define the natural 2-isomorphisms $\lambda_{\mathcal{A}} : \mathcal{A} \circ \text{id}_{\mathcal{G}} \Rightarrow \mathcal{A}$ and $\rho_{\mathcal{A}} : \text{id}_{\mathcal{G}'} \circ \mathcal{A} \Rightarrow \mathcal{A}$ for a given 1-morphism $\mathcal{A} : \mathcal{G} \rightarrow \mathcal{G}'$, and we have to show that they satisfy axiom (2C2). We define the 2-morphism $\lambda_{\mathcal{A}}$ as follows: the 1-morphism $\mathcal{A} \circ \text{id}_{\mathcal{G}}$ has the canonical surjective submersion from $\tilde{Z} = Y^{[2]} \times_Y Z \cong Y \times_M Z$ to $P := Y \times_M Y'$ and the vector bundle $L \otimes A$ over \tilde{Z} . Consider

$$W := \tilde{Z} \times_P Z \cong Z \times_{Y'} Z$$

and the identity $\omega := \text{id}_W$. Under the latter identification, let us consider the restriction of the isomorphism α of the 1-morphism \mathcal{A} from $Z \times_M Z$ to $W = Z \times_{Y'} Z$. If $s : W \rightarrow W$ denotes the exchange of the two factors, we obtain an isomorphism

$$s^* \alpha|_W : L \otimes \zeta_1^* A \rightarrow \zeta_2^* A \otimes \Delta^* L'$$

of vector bundles over W . By composition with the canonical trivialization of the line bundle $\Delta^* L'$ from Lemma 2.1.3 it gives an isomorphism

$$\lambda_W := (\text{id} \otimes t_{\mu'}) \circ s^* \alpha|_W : L \otimes \zeta_1^* A \rightarrow \zeta_2^* A$$

of vector bundles over W . The axiom (2M) for the triple (W, ω, λ_W) follows from axiom (1M2) for the 1-morphism \mathcal{A} and from the properties of $t_{\mu'}$ from Lemma 2.1.3. So, $\lambda_{\mathcal{A}}$ is defined to be the equivalence class of this triple.

The definition of $\rho_{\mathcal{A}}$ goes analogously: we take $W = Z \times_Y Z$ and obtain by restriction the isomorphism

$$\alpha|_W : \Delta^* L \otimes \zeta_2^* A \rightarrow \zeta_1^* A \otimes L'.$$

Then, the 2-isomorphism $\rho_{\mathcal{A}}$ is defined by the triple (W, ω, ρ_W) with the isomorphism

$$\rho_W := (t_{\mu} \otimes \text{id}) \circ \alpha|_W^{-1} : \zeta_1^* A \otimes L' \rightarrow \zeta_2^* A$$

of vector bundles over W .

Lemma 2.3.1. *The 2-isomorphisms $\lambda_{\mathcal{A}}$ and $\rho_{\mathcal{A}}$ are natural in \mathcal{A} , i.e. for any 2-morphism $\beta : \mathcal{A} \Rightarrow \mathcal{A}'$ the naturality squares*

$$\begin{array}{ccc} \text{id}_{\mathcal{G}'} \circ \mathcal{A} & \xrightarrow{\rho_{\mathcal{A}}} & \mathcal{A} \\ \text{id}_{\text{id}_{\mathcal{G}'}} \circ \beta \downarrow & & \downarrow \beta \\ \text{id}_{\mathcal{G}'} \circ \mathcal{A}' & \xrightarrow{\rho_{\mathcal{A}'}} & \mathcal{A}' \end{array} \quad \text{and} \quad \begin{array}{ccc} \mathcal{A} \circ \text{id}_{\mathcal{G}} & \xrightarrow{\lambda_{\mathcal{A}}} & \mathcal{A} \\ \beta \circ \text{id}_{\text{id}_{\mathcal{G}}} \downarrow & & \downarrow \beta \\ \mathcal{A}' \circ \text{id}_{\mathcal{G}} & \xrightarrow{\lambda_{\mathcal{A}'}} & \mathcal{A}' \end{array}$$

are commutative. In terms of equations, the commutativity of these diagrams is equivalent to

$$\beta \bullet \rho_{\mathcal{A}} = \rho_{\mathcal{A}'} \bullet (\text{id}_{\text{id}_{\mathcal{G}'}} \circ \beta) \quad \text{and} \quad \beta \bullet \lambda_{\mathcal{A}} = \lambda_{\mathcal{A}'} \bullet (\beta \circ \text{id}_{\text{id}_{\mathcal{G}}}).$$

Proof. To calculate for instance the horizontal composition $\text{id}_{\text{id}_{\mathcal{G}'}} \circ \beta$ in the diagram on the left hand side first note that $\text{id}_{\text{id}_{\mathcal{G}'}}$ is canonically represented by the triple $(Y'^{[2]}, \text{id}, \text{id}_L)$. The isomorphism

$$d_{\text{id}_{\mathcal{G}' \circ \mathcal{A}}} : \tilde{\zeta}_1^*(A \otimes L') \rightarrow \tilde{\zeta}_2^*(A \otimes L'),$$

which appears in the definition of the horizontal composition, is an isomorphism of vector bundles over $\tilde{Z} \times_{Y \times_M Y'} \tilde{Z}$, where $\tilde{\zeta} : \tilde{Z} := Z \times_M Y' \rightarrow Y \times_M Y'$ is the surjective submersion of the composite $\text{id}_{\mathcal{G}' \circ \mathcal{A}}$. Here it simplifies to

$$d_{\text{id}_{\mathcal{G}' \circ \mathcal{A}}} = (t_\mu \otimes \text{id} \otimes \text{id}) \circ (\alpha^{-1} \otimes \text{id}) \circ (1 \otimes \tilde{\zeta}_1^* \mu^{-1}).$$

With these simplifications and with axiom (1M2) for \mathcal{A} and \mathcal{A}' , the naturality squares reduce to the compatibility axiom (2M) of β with the isomorphisms α and α' of \mathcal{A} and \mathcal{A}' respectively. \blacksquare

It remains to show that the isomorphisms $\lambda_{\mathcal{A}}$ and $\rho_{\mathcal{A}}$ satisfy axiom (2C2) of a 2-category.

Proposition 2.3.2. *For 1-morphisms $\mathcal{A} : \mathcal{G}_1 \rightarrow \mathcal{G}_2$ and $\mathcal{A}' : \mathcal{G}_2 \rightarrow \mathcal{G}_3$, the 2-isomorphisms $\lambda_{\mathcal{A}}$ and $\rho_{\mathcal{A}}$ satisfy*

$$\text{id}_{\mathcal{A}'} \circ \rho_{\mathcal{A}} = \lambda_{\mathcal{A}'} \circ \text{id}_{\mathcal{A}}.$$

Proof. The equation to prove is an equation of 2-morphisms from $\mathcal{A}' \circ \text{id}_{\mathcal{G}_2} \circ \mathcal{A}$ to $\mathcal{A}' \circ \mathcal{A}$. The first 1-morphism consists of the surjective submersion $\tilde{Z} := Z \times_M Z' \rightarrow P_{13}$, where we define $P_{ij} := Y_i \times_M Y_j$, further of the vector bundle $A \otimes L_2 \otimes A'$ over \tilde{Z} . The second 1-morphism $\mathcal{A}' \circ \mathcal{A}$ consists of the surjective submersion $\tilde{Z}' := Z \times_{Y_2} Z' \rightarrow P_{13}$ and the vector bundle $A \otimes A'$ over \tilde{Z}' . Let us choose the defining representatives for the involved 2-morphisms: we choose $(Z'^{[2]}, \text{id}, d_{\mathcal{A}'})$ for $\text{id}_{\mathcal{A}'}$, with $W := Z \times_{Y_1} Z$ we choose (W, id, ρ_W) for $\rho_{\mathcal{A}}$, with $W' := Z' \times_{Y_3} Z'$ we choose $(W', \text{id}, \lambda_{W'})$ for $\lambda_{\mathcal{A}'}$, and we choose $(Z'^{[2]}, \text{id}, d_{\mathcal{A}'})$ for $\text{id}_{\mathcal{A}}$.

Now, the horizontal composition $\text{id}_{\mathcal{A}'} \circ \rho_{\mathcal{A}}$ is defined by the triple (V, ν, β_V) with

$$V = \tilde{Z} \times_{P_{13}} (W \times_{Y_2} Z'^{[2]}) \times_{P_{13}} \tilde{Z}',$$

the projection $\nu : V \rightarrow \tilde{Z} \times_{P_{13}} \tilde{Z}'$ on the first and the last factor, and the isomorphism

$$\beta_V = d_{\mathcal{A}' \circ \mathcal{A}} \circ (\rho_W \otimes d_{\mathcal{A}'}) \circ d_{\mathcal{A}' \circ \text{id}_{\mathcal{A}}}$$

of vector bundles over V . The horizontal composition $\lambda_{\mathcal{A}'} \circ \text{id}_{\mathcal{A}}$ is defined by the triple $(V', \nu', \beta_{V'})$ with

$$V' = \tilde{Z} \times_{P_{13}} (Z'^{[2]} \times_{Y_2} W') \times_{P_{13}} \tilde{Z}',$$

again the projection ν' on the first and the last factor, and the isomorphism

$$\beta_{V'} = d_{\mathcal{A}' \circ \mathcal{A}} \circ (d_{\mathcal{A}} \otimes \lambda_{W'}) \circ d_{\mathcal{A}' \circ \text{id} \circ \mathcal{A}}$$

of vector bundles over V .

To prove the proposition, we show that the triples (V, ν, β_V) and $(V', \nu', \beta_{V'})$ are equivalent. Consider the fibre product

$$X := V \times_{(\tilde{Z} \times_{F_{13}} \tilde{Z}')} V'$$

with surjective submersions $v : X \rightarrow V$ and $v' : X \rightarrow V'$. The equivalence of the two triples follows from the equation

$$v^* \beta_V = v'^* \beta'$$

of isomorphisms of vector bundles over X . It is equivalent to the commutativity of the outer shape of the following diagram of isomorphisms of vector bundles over X :

$$\begin{array}{ccc}
 & A \otimes L_2 \otimes A' & \\
 d_{\mathcal{A}' \circ \text{id} \circ \mathcal{A}} \swarrow & & \searrow d_{\mathcal{A}' \circ \text{id} \circ \mathcal{A}} \\
 v^*(A \otimes L_2 \otimes A') & \xrightarrow{d_{\mathcal{A}' \circ \text{id} \circ \mathcal{A}}} & v'^*(A \otimes L_2 \otimes A') \\
 \rho_W \otimes d_{\mathcal{A}'} \downarrow & & \downarrow d_{\mathcal{A}} \otimes \lambda_{W'} \\
 v^*(A \otimes A') & \xrightarrow{d_{\mathcal{A}' \circ \mathcal{A}}} & v'^*(A \otimes A') \\
 d_{\mathcal{A}' \circ \mathcal{A}} \swarrow & & \searrow d_{\mathcal{A}' \circ \mathcal{A}} \\
 & A \otimes A' &
 \end{array}$$

The diagram is patched together from three subdiagrams, and the commutativity of the outer shape follows because the three subdiagrams are commutative: the triangle diagrams are commutative due to the cocycle condition from Lemma 2.1.4 b) for the 1-morphisms $\mathcal{A}' \circ \text{id}_{\mathcal{G}_2} \circ \mathcal{A}$ and $\mathcal{A}' \circ \mathcal{A}$ respectively. The commutativity of the rectangular diagram in the middle follows from Lemma 2.1.3 and from axioms (1M2) for \mathcal{A} and \mathcal{A}' . ■

Now we have finished the definition of the 2-category $\mathfrak{BGrb}(M)$ of bundle gerbes over M . It provides us with a precise framework to work in. For example, we may now address the question, which of the 1-morphisms are invertible.

Definition 2.3.3. In a (strictly associative) 2-category, a 1-morphism $\mathcal{A} : \mathcal{G}_1 \rightarrow \mathcal{G}_2$ is called *invertible* or *1-isomorphism*, if there exists a 1-morphism $\mathcal{A}^{-1} : \mathcal{G}_2 \rightarrow \mathcal{G}_1$ in the opposite direction, together with 2-isomorphisms

$$i_l : \mathcal{A}^{-1} \circ \mathcal{A} \Rightarrow \text{id}_{\mathcal{G}_1} \quad \text{and} \quad i_r : \text{id}_{\mathcal{G}_2} \Rightarrow \mathcal{A} \circ \mathcal{A}^{-1}$$

such that the diagrams

$$\begin{array}{ccc} \mathcal{A}^{-1} \circ \mathcal{A} \circ \mathcal{A}^{-1} & \xrightarrow{i_l \circ \text{id}_{\mathcal{A}^{-1}}} & \text{id}_{\mathcal{G}_1} \circ \mathcal{A}^{-1} \\ \uparrow \text{id}_{\mathcal{A}} \circ i_r & & \downarrow \rho_{\mathcal{A}^{-1}} \\ \mathcal{A}^{-1} \circ \text{id}_{\mathcal{G}_2} & \xrightarrow{\lambda_{\mathcal{A}^{-1}}} & \mathcal{A} \end{array} \quad \text{and} \quad \begin{array}{ccc} \mathcal{A} \circ \mathcal{A}^{-1} \circ \mathcal{A} & \xrightarrow{\text{id}_{\mathcal{A}} \circ i_l} & \mathcal{A} \circ \text{id}_{\mathcal{G}_1} \\ \uparrow i_r \circ \text{id}_{\mathcal{A}} & & \downarrow \lambda_{\mathcal{A}} \\ \text{id}_{\mathcal{G}_2} \circ \mathcal{A} & \xrightarrow{\rho_{\mathcal{A}}} & \mathcal{A} \end{array}$$

of 2-isomorphisms are commutative.

One can easily show that the inverse 1-isomorphism \mathcal{A}^{-1} is unique up to a 2-isomorphism, and that the composition of 1-isomorphisms is again a 1-isomorphism. Also notice that if $\beta : \mathcal{A} \Rightarrow \mathcal{A}'$ is a 2-morphism between invertible 1-morphisms we can form a 2-morphism $\beta^\# : \mathcal{A}'^{-1} \Rightarrow \mathcal{A}^{-1}$ using the 2-isomorphisms i_r for \mathcal{A}^{-1} and i_l for \mathcal{A}'^{-1} . Then, the commutative diagrams in Definition 2.3.3 induce the equation $\text{id}_{\mathcal{A}'}^\# = \text{id}_{\mathcal{A}^{-1}}$.

Proposition 2.3.4. A 1-morphism $\mathcal{A} : \mathcal{G}_1 \rightarrow \mathcal{G}_2$ in $\mathfrak{BGrb}(M)$ is invertible if and only if the vector bundle of \mathcal{A} is of rank 1.

Proof. Suppose that \mathcal{A} is invertible, and let n be the rank of its vector bundle. Let \mathcal{A}^{-1} be an inverse 1-morphism with a vector bundle of rank m . By definition, the composed 1-morphisms $\mathcal{A} \circ \mathcal{A}^{-1}$ and $\mathcal{A}^{-1} \circ \mathcal{A}$ have vector bundles of rank nm , which has – to admit the existence of the 2-isomorphisms i_l and i_r – to coincide with the rank of the vector bundle of the identity 1-morphisms $\text{id}_{\mathcal{G}_1}$ and $\text{id}_{\mathcal{G}_2}$ respectively, which is 1. So $n = m = 1$. The other inclusion is shown below by an explicit construction of an inverse 1-morphism \mathcal{A}^{-1} to a 1-morphism \mathcal{A} with vector bundle of rank 1. ■

Let a 1-morphism $\mathcal{A} : \mathcal{G}_1 \rightarrow \mathcal{G}_2$ consist of a surjective submersion $\zeta : Z \rightarrow Y_1 \times_M Y_2$, of a vector bundle A over Z and of an isomorphism α of line bundles over $Z \times_M Z$. We construct a 1-morphism $\mathcal{A}^{-1} : \mathcal{G}_2 \rightarrow \mathcal{G}_1$: it has the surjective submersion $Z \rightarrow Y_1 \times_M Y_2 \rightarrow Y_2 \times_M Y_1$, where the first map is ζ and the second one exchanges the factors, the dual vector bundle A^* over Z and the isomorphism

$$\begin{array}{c}
L_2 \otimes \zeta_2^* A^* = \zeta_1^* A^* \otimes \zeta_1^* A \otimes L_2 \otimes \zeta_2^* A^* \\
\downarrow \text{id} \otimes \alpha^{-1} \otimes \text{id} \\
\zeta_1^* A^* \otimes L_1 \otimes \zeta_2^* A \otimes \zeta_2^* A^* = \zeta_1^* A^* \otimes L_1.
\end{array}$$

Axiom (1M1) for the 1-morphism \mathcal{A}^{-1} is satisfied because A^* has the negative curvature, and axiom (1M2) follows from the one for \mathcal{A} .

To construct the 2-isomorphism $i_l : \mathcal{A}^{-1} \circ \mathcal{A} \Rightarrow \text{id}_{\mathcal{G}_1}$ notice that the 1-morphism $\mathcal{A}^{-1} \circ \mathcal{A}$ consists of the line bundle $\zeta_1^* A \otimes \zeta_2^* A^*$ over $\tilde{Z} = Z \times_{Y_2} Z$. We identify $\tilde{Z} \cong \tilde{Z} \times_P Y_1^{[2]}$, where $P = Y_1^{[2]}$, which allows us to choose a triple $(\tilde{Z}, \text{id}_{\tilde{Z}}, \beta_{\tilde{Z}})$ defining i_l . In this triple, the isomorphism $\beta_{\tilde{Z}}$ is defined to be the composition

$$\zeta_1^* A \otimes \zeta_2^* A^* \xrightarrow{\text{id} \otimes t_{\mu_2}^{-1} \otimes \text{id}} \zeta_1^* A \otimes \Delta^* L_2 \otimes \zeta_2^* A^* \xrightarrow{\alpha^{-1} \otimes \text{id}} L_1 \otimes \zeta_2^* A \otimes \zeta_2^* A^* = L_1.$$

Axiom (2M) for the isomorphism $\beta_{\tilde{Z}}$ follows from axiom (1M2) of \mathcal{A} , so that the triple $(\tilde{Z}, \text{id}_{\tilde{Z}}, \beta_{\tilde{Z}})$ defines a 2-isomorphism $i_l : \mathcal{A}^{-1} \circ \mathcal{A} \Rightarrow \text{id}_{\mathcal{G}_1}$. The 2-isomorphism $i_r : \text{id}_{\mathcal{G}_2} \Rightarrow \mathcal{A} \circ \mathcal{A}^{-1}$ is constructed analogously: here we take the isomorphism

$$L_2 = \zeta_1^* A^* \otimes \zeta_1^* A \otimes L_2 \xrightarrow{\text{id} \otimes \alpha^{-1}} \zeta_1^* A^* \otimes \Delta^* L_1 \otimes \zeta_2^* A \xrightarrow{\text{id} \otimes t_{\mu_1} \otimes \text{id}} \zeta_1^* A^* \otimes \zeta_2^* A.$$

of line bundles over W . Notice that by using the pairing $A^* \otimes A = \mathbb{1}$ we have used that A is a line bundle as assumed. Finally, the commutativity of the diagrams in Definition 2.3.3 follows from axiom (1M2) of \mathcal{A} .

Proposition 2.3.4 shows that we have many 1-morphisms in $\mathfrak{BGrb}(M)$ which are not invertible, in contrast to the 2-groupoid of bundle gerbes defined in [Ste00]. Notice that we have already benefited from the simple definition of the composition $\mathcal{A}^{-1} \circ \mathcal{A}$, which makes it also easy to see that it is compatible with our construction of inverse 1-morphisms \mathcal{A}^{-1} :

$$(\mathcal{A}_2 \circ \mathcal{A}_1)^{-1} = \mathcal{A}_1^{-1} \circ \mathcal{A}_2^{-1}.$$

In a general 2-category, one forms a groupoid $\mathfrak{Iso}(\mathcal{G}, \mathcal{H})$ as the subgroupoid of $\mathfrak{Hom}(\mathcal{G}, \mathcal{H})$ consisting of 1-isomorphisms and invertible 2-morphisms between them. In our case of the 2-category $\mathfrak{BGrb}(M)$, the groupoid $\mathfrak{Iso}(\mathcal{G}, \mathcal{H})$ is full. Also notice that the assignment of inverses to 1-morphisms defines an equivalence of groupoids

$$()^{-1} : \mathfrak{Iso}(\mathcal{G}, \mathcal{H}) \rightarrow \mathfrak{Iso}(\mathcal{H}, \mathcal{G}),$$

which sends a 1-isomorphism $\mathcal{A} : \mathcal{G} \rightarrow \mathcal{H}$ to its inverse $\mathcal{A}^{-1} : \mathcal{H} \rightarrow \mathcal{G}$ and a 2-isomorphism $\beta : \mathcal{A} \Rightarrow \mathcal{A}'$ to the 2-isomorphism $\beta^{\#-1} : \mathcal{A}^{-1} \Rightarrow \mathcal{A}'^{-1}$.

Let us finally stress the particular importance of the Hom-categories of endomorphisms $\mathbf{End}(\mathcal{G}) := \mathfrak{Hom}(\mathcal{G}, \mathcal{G})$ for one bundle gerbe \mathcal{G} , and its full subgroupoid of automorphisms $\mathfrak{Aut}(\mathcal{G}) := \mathfrak{Iso}(\mathcal{G}, \mathcal{G})$. Since in a higher gauge theory like the sigma models we have defined in §1.6 a bundle gerbe \mathcal{G} defines the gauge field to which strings couple, we call $\mathfrak{Aut}(\mathcal{G})$ the *gauge groupoid* of \mathcal{G} . It is the appropriate categorification of the gauge group in a gauge theory for point-like particles.

2.4 Descent Theory for Morphisms

In this section we return to the discussion of the relation between 1-morphisms in the sense of Definition 2.1.1 and stable isomorphisms in the sense of Definition 1.2.1. For this purpose, we introduce the subcategory $\mathfrak{Hom}_{FP}(\mathcal{G}_1, \mathcal{G}_2)$ of the Hom-category $\mathfrak{Hom}(\mathcal{G}_1, \mathcal{G}_2)$, consisting of all those 1-morphisms $\mathcal{A} : \mathcal{G}_1 \Rightarrow \mathcal{G}_2$ whose surjective submersion $\zeta : Z \rightarrow P := Y_1 \times_M Y_2$ is the identity, implying $Z = P$, and consisting of all those 2-morphisms $\beta : \mathcal{A} \Rightarrow \mathcal{A}'$ which can be represented by a triple (P, ω, β) where $\omega : P \rightarrow P \times_P P \cong P$ is also the identity. This category $\mathfrak{Hom}_{FP}(\mathcal{G}_1, \mathcal{G}_2)$ contains in particular stable isomorphisms and the 2-isomorphisms from §1.3.

Theorem 2.4.1. *The inclusion functor*

$$D : \mathfrak{Hom}_{FP}(\mathcal{G}_1, \mathcal{G}_2) \rightarrow \mathfrak{Hom}(\mathcal{G}_1, \mathcal{G}_2)$$

is an equivalence of categories.

In the proof we will use the fact that vector bundles form a sheaf of categories. Following [Bry93] we use surjective submersions instead of open covers like in [Moe], and define first a presheaf a categories.

Definition 2.4.2. *A presheaf of categories \mathcal{F} over M consists of*

- (a) *a category $\mathcal{F}(Y)$ for each surjective submersion $\pi : Y \rightarrow M$.*
- (b) *a functor $\mathcal{F}(p) : \mathcal{F}(Y_2) \rightarrow \mathcal{F}(Y_1)$ for each morphism $p : Y_1 \rightarrow Y_2$ of surjective submersions.*
- (c) *a natural equivalence*

$$\mathcal{F}(p, p') : \mathcal{F}(p' \circ p) \rightarrow \mathcal{F}(p) \circ \mathcal{F}(p')$$

for each pair $p : Y_1 \rightarrow Y_2$, $p' : Y_2 \rightarrow Y_3$ of composable morphisms of surjective submersions.

We require for three composable morphisms of surjective submersions p , p' and $p'' : Y_3 \rightarrow Y_4$ the equality

$$\begin{array}{ccc}
 \mathcal{F}(Y_4) & \xrightarrow{\mathcal{F}(p'' \circ p' \circ p)} & \mathcal{F}(Y_1) \\
 \downarrow \mathcal{F}(p'') & \searrow \mathcal{F}(p, p'' \circ p') & \downarrow \mathcal{F}(p, p'' \circ p') \\
 & \mathcal{F}(p) & \\
 & \swarrow \mathcal{F}(p, p') & \downarrow \mathcal{F}(p, p') \\
 \mathcal{F}(Y_3) & \xrightarrow{\mathcal{F}(p')} & \mathcal{F}(Y_2) \\
 \uparrow \mathcal{F}(p) & & \uparrow \mathcal{F}(p)
 \end{array}
 =
 \begin{array}{ccc}
 \mathcal{F}(Y_4) & \xrightarrow{\mathcal{F}(p'' \circ p' \circ p)} & \mathcal{F}(Y_1) \\
 \downarrow \mathcal{F}(p'') & \searrow \mathcal{F}(p' \circ p, p'') & \downarrow \mathcal{F}(p' \circ p, p'') \\
 & \mathcal{F}(p) & \\
 & \swarrow \mathcal{F}(p, p') & \downarrow \mathcal{F}(p, p') \\
 \mathcal{F}(Y_3) & \xrightarrow{\mathcal{F}(p')} & \mathcal{F}(Y_2) \\
 \uparrow \mathcal{F}(p) & & \uparrow \mathcal{F}(p)
 \end{array}$$

of natural transformations.

Now we formulate a gluing axiom for a presheaf of categories. For this purpose, we define a *descent category* $\mathfrak{Des}(\mathcal{F}, \pi)$ for a given presheaf of categories \mathcal{F} and any surjective submersion $\pi : Y \rightarrow M$ as follows:

- 1.) its objects are pairs (A, α) where A is an object of the category $\mathcal{F}(Y)$ and $\alpha : \mathcal{F}(\pi_1)(A) \rightarrow \mathcal{F}(\pi_2)(A)$ is a morphism in the category $\mathcal{F}(Y^{[2]})$ such that $\mathcal{F}(\pi_{11})(\alpha) = \text{id}_{\mathcal{F}(\pi_1)(A)}$ and

$$\mathcal{F}(\pi_{13})(\alpha) = \mathcal{F}(\pi_{23})(\alpha) \circ \mathcal{F}(\pi_{12})(\alpha). \quad (2-10)$$

- 2.) a morphism $(A, \alpha) \rightarrow (A', \alpha')$ is a morphism $\beta : A \rightarrow A'$ in the category $\mathcal{F}(Y)$ such that the diagram

$$\begin{array}{ccc}
 \mathcal{F}(\pi_1)(A) & \xrightarrow{\mathcal{F}(\pi_1)(\beta)} & \mathcal{F}(\pi_1)(A') \\
 \alpha \downarrow & & \downarrow \alpha' \\
 \mathcal{F}(\pi_2)(A) & \xrightarrow{\mathcal{F}(\pi_2)(\beta)} & \mathcal{F}(\pi_2)(A')
 \end{array}$$

of morphisms in the category $\mathcal{F}(Y^{[2]})$ is commutative.

- 3.) the composition of morphisms is just the composition of morphisms in $\mathcal{F}(Y)$.

Notice that the pullback along π defines a canonical functor

$$D_\pi : \mathcal{F}(M) \rightarrow \mathfrak{Des}(\mathcal{F}, \pi).$$

Definition 2.4.3. A presheaf of categories \mathcal{F} is called *sheaf of categories*, provided D_π is an equivalence of categories for each surjective submersion π .

The example we need here is the presheaf of categories \mathcal{Bun} , which assigns to any surjective submersion $\pi : Y \rightarrow M$ the category $\mathfrak{Bun}(Y)$ of vector bundles over Y . It is easy to verify that the conditions on the objects and morphisms of $\mathfrak{Des}(\mathcal{Bun}, \pi)$ assure that the functors D_π are equivalences of categories, so that \mathcal{Bun} is a sheaf of categories.

Now we are ready to give the

Proof of Theorem 2.4.1. We show that the faithful functor D is an equivalence of categories by proving (a) that it is essentially surjective and (b) that the subcategory $\mathfrak{Hom}_{FP}(\mathcal{G}_1, \mathcal{G}_2)$ is full.

For (a) we have to show that for every 1-morphism $\mathcal{A} : \mathcal{G}_1 \rightarrow \mathcal{G}_2$ with arbitrary surjective submersion $\zeta : Z \rightarrow P$ there is an isomorphic 1-morphism $\mathcal{S}_{\mathcal{A}} : \mathcal{G}_1 \rightarrow \mathcal{G}_2$ with surjective submersion id_P . Notice that the isomorphism $d_{\mathcal{A}} : \zeta_1^* A \rightarrow \zeta_2^* A$ of vector bundles over $Z^{[2]}$ from Lemma 2.1.4 satisfies the cocycle condition (2-10), so that $(A, d_{\mathcal{A}})$ is an object in $\mathfrak{Des}(\mathcal{Bun}, \zeta)$. Now consider the surjective submersion $\zeta^2 : Z \times_M Z \rightarrow P^{[2]}$. By Lemma 2.1.4 b) and under the identification of $Z^{[2]} \times_M Z^{[2]}$ with $(Z \times_M Z) \times_{P^{[2]}} (Z \times_M Z)$ the diagram

$$\begin{array}{ccc} L_1 \otimes \zeta_2^* A & \xrightarrow{\zeta_{12}^* \alpha} & \zeta_1^* A \otimes L_2 \\ \downarrow 1 \otimes \zeta_{24}^* d_{\mathcal{A}} & & \downarrow \zeta_{13}^* d_{\mathcal{A}} \otimes 1 \\ L_1 \otimes \zeta_4^* A & \xrightarrow{\zeta_{34}^* \alpha} & \zeta_3^* A \otimes L_2 \end{array}$$

of isomorphisms of vector bundles over $(Z \times_M Z) \times_{P^{[2]}} (Z \times_M Z)$ is commutative, and shows that α is a morphism in $\mathfrak{Des}(\mathcal{Bun}, \zeta^2)$. Now we use that $\zeta^* = D_{\zeta}$ is an equivalence of categories: we choose a vector bundle S over P together with an isomorphism $\beta : \zeta^* S \rightarrow A$ of vector bundles over Z , and an isomorphism

$$\sigma : L_1 \otimes \zeta_2^* S \rightarrow \zeta_1^* S \otimes L_2$$

of vector bundles over $P \times_M P$ such that the diagram

$$\begin{array}{ccc} L_1 \otimes \zeta_2^* \zeta^* S & \xrightarrow{\zeta^* \sigma} & \zeta_1^* \zeta^* S \otimes L_2 \\ \downarrow \text{id} \otimes \zeta_2^* \beta & & \downarrow \zeta_1^* \beta \otimes \text{id} \\ L_1 \otimes \zeta_2^* A & \xrightarrow{\alpha} & \zeta_1^* A \otimes L_2 \end{array} \quad (2-11)$$

of isomorphisms of vector bundles over $Z \times_M Z$ is commutative. Since ζ is an equivalence of categories, the axioms of \mathcal{A} imply the ones of the 1-morphism $\mathcal{S}_{\mathcal{A}}$ defined by the surjective submersion id_P , the vector bundle S over P and the isomorphism σ over $P^{[2]}$. Finally, the triple $(Z \times_P P, \text{id}_Z, \beta)$ with $Z \cong Z \times_P P$ defines a 2-morphism $\mathcal{S}_{\mathcal{A}} \Rightarrow \mathcal{A}$, whose axiom (2M) is given by the commutativity of diagram (2-11).

(b) We have to show that any morphism $\beta : \mathcal{A} \Rightarrow \mathcal{A}'$ in $\mathfrak{Hom}(\mathcal{G}_1, \mathcal{G}_2)$ between objects \mathcal{A} and \mathcal{A}' in $\mathfrak{Hom}_{FP}(\mathcal{G}_1, \mathcal{G}_2)$ is already a morphism in $\mathfrak{Hom}_{FP}(\mathcal{G}_1, \mathcal{G}_2)$. Let (W, ω, β_W) be any representative of β with a surjective submersion $\omega : W \rightarrow P$ and an isomorphism $\beta_W : \omega^* A \rightarrow \omega^* A'$ of vector bundles over W . The restriction of axiom (2M) for the triple (W, ω, β_W) from $W \times_M W$ to $W \times_P W$ shows $\omega_1^* \beta_W = \omega_2^* \beta_W$. This shows that β_W is a morphism in the descent category $\mathfrak{Des}(\mathcal{Bun}, \omega)$. Let $\beta_P : A \rightarrow A'$ be an isomorphism of vector bundles over P such that

$$\omega^* \beta_P = \beta_W \quad (2-12)$$

Because ω is an equivalence of categories, the triple $(P, \text{id}_P, \beta_P)$ defines a 2-morphism from \mathcal{A} to \mathcal{A}' being a morphism in $\mathfrak{Hom}_{FP}(\mathcal{G}_1, \mathcal{G}_2)$. Equation (2-12) shows that the triples $(P, \text{id}_P, \beta_P)$ and (W, ω, β_W) are equivalent. ■

In the following we draw some important consequences. From Proposition 2.3.4 and Theorem 2.4.1 we obtain

Corollary 2.4.4. *Every 1-isomorphism is isomorphic to a stable isomorphism, so that two bundle gerbes are stably isomorphic if and only if they are 1-isomorphic objects in $\mathfrak{BGrb}(M)$.*

This corollary tells us that our 2-category $\mathfrak{BGrb}(M)$ and the 2-groupoid of [Ste00] have the same *skeletons*, i.e. the same sets of 1-isomorphism classes. As a consequence, all classification results we have developed in Chapter 1 remain true when replacing stable isomorphisms by 1-morphisms from Definition 2.1.1.

Another application of Theorem 2.4.1 is the investigation of the Hom-category $\mathfrak{Hom}(\mathcal{I}_{\rho_1}, \mathcal{I}_{\rho_2})$ between two trivial bundle gerbes given by 2-forms ρ_1 and ρ_2 on M , which appears at various places in this thesis. Via the functor D , this category is equivalent to the category $\mathfrak{Hom}_{FP}(\mathcal{I}_{\rho_1}, \mathcal{I}_{\rho_2})$. In this category, an object $\mathcal{A} : \mathcal{I}_{\rho_1} \rightarrow \mathcal{I}_{\rho_2}$ consists of the smooth manifold $Z = M$ with the surjective submersion $\zeta = \text{id}_M$, of a vector bundle A over M and of an morphism $\alpha : A \rightarrow A$ of vector bundles. Axiom (1M2) states

$$\frac{1}{n} \text{tr}(\text{curv}(A)) = \rho_2 - \rho_1 \quad (2-13)$$

with n the rank of A , and axiom (1M2) reduces to $\alpha^2 = \alpha$, which in turn means $\alpha = \text{id}_A$. In the same way, any morphism $\beta : \mathcal{A} \Rightarrow \mathcal{A}'$ in $\mathfrak{Hom}_{FP}(\mathcal{I}_{\rho_1}, \mathcal{I}_{\rho_2})$, defines a morphism $\beta : A \rightarrow A'$ of the respective vector bundles. This defines a canonical equivalence of categories

$$\mathfrak{Hom}_{FP}(\mathcal{I}_{\rho_1}, \mathcal{I}_{\rho_2}) \cong \mathfrak{Bun}_{\rho_2 - \rho_1}(M),$$

where $\mathfrak{Bun}_{\rho_2 - \rho_1}(M)$ is the category of vector bundles over M whose curvature satisfies (2-13). The composite of the functor D from Theorem 2.4.1 with this equivalence of categories is denoted by Bun .

Proposition 2.4.5. *The functor*

$$\text{Bun} : \mathfrak{Hom}(\mathcal{I}_{\rho_1}, \mathcal{I}_{\rho_2}) \rightarrow \mathfrak{Bun}_{\rho_2 - \rho_1}(M)$$

is an equivalence of categories. Furthermore,

(i) *it respects the composition of 1-morphisms:*

$$\text{Bun}(\mathcal{A}_2 \circ \mathcal{A}_1) = \text{Bun}(\mathcal{A}_1) \otimes \text{Bun}(\mathcal{A}_2) \quad \text{and} \quad \text{Bun}(\text{id}_{\mathcal{I}_\rho}) = \mathbf{1}.$$

(ii) it restricts to an equivalence of groupoids

$$\text{Bun} : \mathcal{I}\text{so}(\mathcal{I}_{\rho_1}, \mathcal{I}_{\rho_2}) \rightarrow \mathcal{L}\text{in}_{\rho_2 - \rho_1}(M)$$

to the groupoid of line bundles over M with curvature $\rho_2 - \rho_1$, and this restriction satisfies

$$\text{Bun}(\mathcal{A}^{-1}) = \text{Bun}(\mathcal{A})^* \quad \text{and} \quad \text{Bun}(\beta^\#) = \beta^*.$$

The claims of this proposition follow immediately from Theorem 2.4.1, the definition of the composition functor and the one of inverse 1-isomorphisms. To give a demonstration of the importance of the Hom-categories between trivial bundle gerbes, we make the following improvement of Corollary 1.3.10 iii).

Corollary 2.4.6. *Two trivializations $\mathcal{T}_1 : \mathcal{G} \rightarrow \mathcal{I}_{\rho_1}$ and $\mathcal{T}_2 : \mathcal{G} \rightarrow \mathcal{I}_{\rho_2}$ of the same bundle gerbe \mathcal{G} determine a line bundle $\text{Bun}(\mathcal{T}_2 \circ \mathcal{T}_1^{-1})$ over M of curvature $\rho_2 - \rho_1$. In particular, the 2-form $\rho_2 - \rho_1$ is closed and has an integral class.*

At the end of the following section we will encounter an even more general statement about an observation that two 1-isomorphisms differ by a line bundle.

2.5 Pullbacks, Tensor Products and Duality

In Chapter 1 we have introduced three natural constructions for bundle gerbes: pullbacks, duals and tensor products. All these constructions have natural extensions to the 2-category $\mathfrak{B}\mathfrak{G}\mathfrak{r}\mathfrak{b}(M)$ of bundle gerbes.

Similarly to the definition of the tensor product of two bundle gerbes we have given in §1.1 one can define tensor products of 1-morphisms and 2-morphisms, whose details we omit here. This yields a monoidal structure on the 2-category $\mathfrak{B}\mathfrak{G}\mathfrak{r}\mathfrak{b}(M)$ in terms of a strict 2-functor

$$\otimes : \mathfrak{B}\mathfrak{G}\mathfrak{r}\mathfrak{b}(M) \times \mathfrak{B}\mathfrak{G}\mathfrak{r}\mathfrak{b}(M) \rightarrow \mathfrak{B}\mathfrak{G}\mathfrak{r}\mathfrak{b}(M),$$

which is strictly associative, and for which the trivial bundle gerbe \mathcal{I}_0 is a strict tensor unit. Explicitly, this 2-functor assigns to two bundle gerbes \mathcal{G} and \mathcal{H} their tensor product $\mathcal{G} \otimes \mathcal{H}$, to two 1-morphisms $\mathcal{A}_1 : \mathcal{G}_1 \rightarrow \mathcal{H}_1$ and $\mathcal{A}_2 : \mathcal{G}_2 \rightarrow \mathcal{H}_2$ a 1-morphism

$$\mathcal{A}_1 \otimes \mathcal{A}_2 : \mathcal{G}_1 \otimes \mathcal{G}_2 \rightarrow \mathcal{H}_1 \otimes \mathcal{H}_2,$$

and to two 2-morphisms $\beta_1 : \mathcal{A}_1 \rightrightarrows \mathcal{B}_1$ and $\beta_2 : \mathcal{A}_2 \rightrightarrows \mathcal{B}_2$ a 2-morphism

$$\beta_1 \otimes \beta_2 : \mathcal{A}_1 \otimes \mathcal{A}_2 \rightrightarrows \mathcal{B}_1 \otimes \mathcal{B}_2.$$

The strictness refers to the condition that it respects the composition,

$$(\mathcal{B}_1 \otimes \mathcal{B}_2) \circ (\mathcal{A}_1 \otimes \mathcal{A}_2) = (\mathcal{B}_1 \circ \mathcal{A}_1) \otimes (\mathcal{B}_2 \circ \mathcal{A}_2) \quad \text{and} \quad \text{id}_{\mathcal{G}} \otimes \text{id}_{\mathcal{H}} = \text{id}_{\mathcal{G} \otimes \mathcal{H}},$$

and strictly associative means that $(\mathcal{A}_1 \otimes \mathcal{A}_2) \otimes \mathcal{A}_3 = \mathcal{A}_1 \otimes (\mathcal{A}_2 \otimes \mathcal{A}_3)$. The condition concerning the tensor unit \mathcal{I}_0 , namely $\mathcal{I}_0 \otimes \mathcal{G} = \mathcal{G} = \mathcal{G} \otimes \mathcal{I}_0$, we have already discovered in §1.1.

In the same way, the pullback of a bundle gerbe over M along a smooth map $f : X \rightarrow M$ can be extended to 1-morphisms and 2-morphisms in a natural way, defining a strict 2-functor

$$f^* : \mathfrak{BGrb}(M) \rightarrow \mathfrak{BGrb}(X).$$

For a second smooth map $g : Y \rightarrow X$, we have $g^* \circ f^* = (f \circ g)^*$ as an equality of 2-functors. The 2-functors \otimes and f^* are also compatible with the assignment of inverses \mathcal{A}^{-1} to 1-isomorphisms \mathcal{A} from §2.3:

$$f^*(\mathcal{A}^{-1}) = (f^*\mathcal{A})^{-1} \quad \text{and} \quad (\mathcal{A}_1 \otimes \mathcal{A}_2)^{-1} = \mathcal{A}_1^{-1} \otimes \mathcal{A}_2^{-1}.$$

To define a duality we have to be a bit more precise, even though we will strictly confine ourselves on what we need later in Chapters 4 and 5. For those purposes, it is enough to understand the duality as a strict 2-functor

$$()^* : \mathfrak{BGrb}(M)^{\text{op}} \rightarrow \mathfrak{BGrb}(M)$$

where the opposed 2-category $\mathfrak{BGrb}(M)^{\text{op}}$ has all 1-morphisms reversed, while the 2-morphisms are as before. This 2-functor will satisfy the identity

$$()^{**} = \text{id}_{\mathfrak{BGrb}(M)}.$$

As further properties we just note the existence of the duality 1-isomorphism

$$\mathcal{D}_{\mathcal{G}} : \mathcal{G}^* \otimes \mathcal{G} \rightarrow \mathcal{I}_0$$

we have defined in §1.3, and neglect all axioms this 1-isomorphism would have to satisfy in a fully developed theory of a monoidal 2-category with duals, see e.g. [BL03].

We now give the complete definition of the 2-functor $()^*$ on 1-morphisms and 2-morphisms. We recall that for a bundle gerbe \mathcal{G} , the dual bundle gerbe \mathcal{G}^* consists of the same surjective submersion $\pi : Y \rightarrow M$, the curving $-C \in \Omega^2(Y)$, the line bundle L^* over $Y^{[2]}$ and the multiplication

$$\mu^{*-1} : \pi_{12}^* L^* \otimes \pi_{23}^* L^* \rightarrow \pi_{13}^* L^*$$

of line bundles over $Y^{[3]}$. We obtain immediately

$$\mathcal{G}^{**} = \mathcal{G} \quad \text{and} \quad (\mathcal{G} \otimes \mathcal{H})^* = \mathcal{H}^* \otimes \mathcal{G}^*.$$

For a 1-morphism $\mathcal{A} : \mathcal{G}_1 \rightarrow \mathcal{G}_2$ consisting of a vector bundle A over Z with surjective submersion $\zeta : Z \rightarrow P$, where $P := Y_1 \times_M Y_2$, and of an isomorphism α of vector bundles over $Z \times_M Z$, we define the dual 1-morphism

$$\mathcal{A}^* : \mathcal{G}_2^* \rightarrow \mathcal{G}_1^*$$

as follows: its surjective submersion is the composite of ζ with the exchange map $s : P' \rightarrow P$, with $P' := Y_2 \times_M Y_1$. The vector bundle of \mathcal{A}^* is just A over Z , and its isomorphism is

$$\begin{array}{ccc} L_2^* \otimes \zeta_2^* A & \xlongequal{\quad} & L_2^* \otimes L_1 \otimes \zeta_2^* A \otimes L_1^* \\ & & \downarrow \text{id} \otimes \alpha \otimes \text{id} \\ L_2^* \otimes \zeta_1^* A \otimes L_2 \otimes L_1^* & \xlongequal{\quad} & \zeta_1^* A \otimes L_1^*. \end{array}$$

Axiom (1M1) is satisfied since the dual bundle gerbes have curvings with opposite signs,

$$\text{curv}(A) = C_2 - C_1 = (-C_1) - (-C_2).$$

Axiom (1M2) relates the isomorphism $\text{id} \otimes \alpha \otimes \text{id}$ to the isomorphisms μ_1^{*-1} and μ_2^{*-1} of the dual bundle gerbes. It can be deduced from axiom (1M2) of \mathcal{A} using the following general fact, applied to μ_1^* and μ_2^* : the dual f^* of an isomorphism $f : L_1 \rightarrow L_2$ of line bundles coincides with the isomorphism

$$L_2^* = L_2^* \otimes L_1 \otimes L_1^* \xrightarrow{\text{id} \otimes f \otimes \text{id}} L_2^* \otimes L_2 \otimes L_1^* = L_1^*,$$

defined using the duality on line bundles. Dual 1-morphisms defined like this have the properties

$$\mathcal{A}^{**} = \mathcal{A} \quad , \quad (\mathcal{A}' \circ \mathcal{A})^* = \mathcal{A}^* \circ \mathcal{A}'^* \quad \text{and} \quad (\mathcal{A}_1 \otimes \mathcal{A}_2)^* = \mathcal{A}_2^* \otimes \mathcal{A}_1^*,$$

and are furthermore compatible with the definition of inverse 1-isomorphisms,

$$(\mathcal{A}^*)^{-1} = (\mathcal{A}^{-1})^*.$$

Finally, for a 2-morphism $\beta : \mathcal{A}_1 \Rightarrow \mathcal{A}_2$ we define the dual 2-morphism

$$\beta^* : \mathcal{A}_1^* \Rightarrow \mathcal{A}_2^*$$

in the following way. If β is represented by a triple (W, ω, β) with an isomorphism $\beta : A_1 \rightarrow A_2$ of vector bundles over W , the very same triple defines the dual 2-morphism β^* . So it becomes obvious that dual 2-morphisms are compatible with horizontal and vertical composition,

$$(\beta_2 \circ \beta_1)^* = \beta_1^* \circ \beta_2^* \quad \text{and} \quad (\beta \bullet \beta')^* = \beta^* \bullet \beta'^*$$

and satisfy furthermore

$$\beta^{**} = \beta \quad \text{and} \quad (\beta_1 \otimes \beta_2)^* = \beta_2^* \otimes \beta_1^*.$$

Summarizing, we have defined a monoidal strict 2-functor $(\)^*$, which is strictly involutive and furthermore compatible with pullbacks:

$$f^*(\mathcal{G}^*) = (f^*\mathcal{G})^* \quad , \quad f^*\mathcal{A}^* = (f^*\mathcal{A})^* \quad \text{and} \quad f^*\beta^* = (f^*\beta)^*.$$

Now recall from Proposition 2.4.5 in the previous section that there is a canonical equivalence of categories

$$\text{Bun} : \mathfrak{Hom}(\mathcal{I}_{\rho_1}, \mathcal{I}_{\rho_2}) \rightarrow \mathfrak{Bun}_{\rho_2 - \rho_1}(M)$$

between the Hom-category between two trivial bundle gerbes over M and the category of vector bundles over M whose curvature satisfies (2–13). We find

Proposition 2.5.1. *The functor Bun respects all the additional structure of the 2-category of bundle gerbes, namely:*

a) *the monoidal structure,*

$$\text{Bun}(\mathcal{A}_1 \otimes \mathcal{A}_2) = \text{Bun}(\mathcal{A}_1) \otimes \text{Bun}(\mathcal{A}_2).$$

b) *pullbacks,*

$$\text{Bun}(f^*\mathcal{A}) = f^*\text{Bun}(\mathcal{A}) \quad \text{and} \quad \text{Bun}(f^*\beta) = f^*\text{Bun}(\beta).$$

c) *and the duality,*

$$\text{Bun}(\mathcal{A}^*) = \text{Bun}(\mathcal{A}) \quad \text{and} \quad \text{Bun}(\beta^*) = \text{Bun}(\beta).$$

In the following we will demonstrate how the additional structures we have introduced can be used to gain important information about the structure of the Hom-categories. From the definition of the functor Bun it is clear that it has a canonical inverse functor, denoted by Bun^{-1} : it sends a vector bundle A over M whose curvature satisfies (2–13) to the 1-morphism $\mathcal{I}_{\rho_1} \rightarrow \mathcal{I}_{\rho_2}$ whose surjective submersion $\zeta : Z \rightarrow M \times_M M \cong M$ is the identity id_M , whose vector bundle is A , and whose isomorphism is $\alpha := \text{id}_A$. We use this inverse functor in the following construction.

Recall that a (strict) module category over a (strict) monoidal category $(\mathfrak{C}, \mathbf{1}, \otimes)$ is a category \mathfrak{M} together with a strictly associative functor

$$\boxtimes : \mathfrak{C} \times \mathfrak{M} \rightarrow \mathfrak{M}$$

such that $\mathbf{1} \boxtimes M = M$ for all objects M in \mathfrak{M} .

Proposition 2.5.2. *The functor*

$$\mathfrak{Bun}_0(M) \times \mathfrak{Hom}(\mathcal{G}, \mathcal{H}) \xrightarrow{\text{Bun}^{-1} \times \text{id}} \mathfrak{End}(\mathcal{I}_0) \times \mathfrak{Hom}(\mathcal{G}, \mathcal{H}) \xrightarrow{\otimes} \mathfrak{Hom}(\mathcal{G}, \mathcal{H})$$

endows the Hom-category $\mathfrak{Hom}(\mathcal{G}, \mathcal{H})$ with the structure of a module category over the monoidal category $\mathfrak{Bun}_0(M)$ of vector bundles over M whose curvature is of trace zero.

Proof. Following our conventions, the category $\mathfrak{Bun}_0(M)$ is strict monoidal. The category $\mathfrak{End}(\mathcal{I}_0) = \mathfrak{Hom}(\mathcal{I}_0, \mathcal{I}_0)$ together with the composition functor \circ and the identity $\text{id}_{\mathcal{I}_0}$ is also a strict monoidal category. By Proposition 2.4.5 (i), the functor Bun and its inverse are monoidal functors, so that $\mathfrak{Bun}_0(M)$ and $\mathfrak{End}(\mathcal{I}_0)$ are equivalent as monoidal categories. It remains to check that $\mathfrak{Hom}(\mathcal{G}, \mathcal{H})$ is a module category over $\mathfrak{End}(\mathcal{I}_0)$. The condition $\text{id}_{\mathcal{I}_0} \otimes \mathcal{A} = \mathcal{A}$ is clearly satisfied, and the associativity follows from the associativity of the 2-functor \otimes which defines the monoidal structure on $\mathfrak{Grb}(M)$. ■

We write $L \otimes \mathcal{A} : \mathcal{G} \rightarrow \mathcal{H}$ for the action of a vector bundle L on a 1-morphism $\mathcal{A} : \mathcal{G} \rightarrow \mathcal{H}$, and $\varphi \otimes \beta : L \otimes \mathcal{A} \Rightarrow L' \otimes \mathcal{A}'$ for the action of a morphism $\varphi : L \rightarrow L'$ of vector bundles on a 2-morphism $\beta : \mathcal{A} \Rightarrow \mathcal{A}'$.

Next we consider the groupoid $\mathfrak{Iso}(\mathcal{G}, \mathcal{H})$ of isomorphisms between bundle gerbes \mathcal{G} and \mathcal{H} over M as a module category over $\mathfrak{Lin}_0(M)$, by restriction of the module category defined above according to Proposition 2.4.5 (ii). Our aim is to establish that $\mathfrak{Lin}_0(M)$ acts in a free and transitive way on $\mathfrak{Iso}(\mathcal{G}, \mathcal{H})$. We recall that a set M is called a *torsor* over a monoid G acting on M , if the canonical map

$$G \times M \rightarrow M \times M : (g, m) \mapsto (g.m, m)$$

associated to the action is a bijection. This is equivalent to a free and transitive action: the surjectivity of the above map is equivalent to the transitivity, and its injectivity is equivalent to its freeness. This motivates the following

Definition 2.5.3. *Let \mathfrak{M} be a module category over a monoidal category \mathfrak{C} by means of a functor $\boxtimes : \mathfrak{C} \times \mathfrak{M} \rightarrow \mathfrak{M}$. We call \mathfrak{M} a torsor category over \mathfrak{C} , if the functor*

$$\mathfrak{C} \times \mathfrak{M} \xrightarrow{\text{id} \times \Delta} \mathfrak{C} \times \mathfrak{M} \times \mathfrak{M} \xrightarrow{\boxtimes \times \text{id}} \mathfrak{M} \times \mathfrak{M},$$

is an equivalence of categories. Here, $\Delta : \mathfrak{M} \rightarrow \mathfrak{M} \times \mathfrak{M}$ is the diagonal functor.

A natural example for a torsor category arises in abstract higher category theory: first we recall that for any ordinary category, the set of isomorphisms $\text{Iso}(X, Y)$ between two fixed objects X and Y is a torsor over the group $\text{Aut}(Y)$ of automorphisms of Y , where $\text{Aut}(Y)$ acts by post-composition on $\text{Iso}(X, Y)$. In complete analogy, for any 2-category, the groupoid $\mathfrak{Iso}(\mathcal{G}, \mathcal{H})$ of isomorphisms between two fixed objects is a torsor category over the monoidal category $\mathfrak{Aut}(\mathcal{H})$. We do not further expand on this abstract example and return to the concrete module category defined in Proposition 2.5.2.

Theorem 2.5.4. *The groupoid $\mathfrak{Iso}(\mathcal{G}, \mathcal{H})$ of isomorphisms between bundle gerbes \mathcal{G} and \mathcal{H} over M is a torsor category over the category of flat line bundles $\mathfrak{Lin}_0(M)$ over M .*

Proof. We show that the associated functor

$$\mathfrak{Lin}_0(M) \times \mathfrak{Iso}(\mathcal{G}, \mathcal{H}) \rightarrow \mathfrak{Iso}(\mathcal{G}, \mathcal{H}) \times \mathfrak{Iso}(\mathcal{G}, \mathcal{H}) \quad (2-14)$$

is essentially surjective and fully faithful. To show that it is fully faithful we have to consider the map

$$\text{Iso}(L_1, L_2) \times \text{Iso}(\mathcal{A}_1, \mathcal{A}_2) \rightarrow \text{Iso}(L_1 \otimes \mathcal{A}_1, L_2 \otimes \mathcal{A}_2) \times \text{Iso}(\mathcal{A}_1, \mathcal{A}_2) \quad (2-15)$$

where $\text{Iso}(L_1, L_2)$ is the set of isomorphisms between two flat line bundles L_1 and L_2 over M , and $\text{Iso}(\mathcal{A}_1, \mathcal{A}_2)$ is the set of 2-isomorphisms between two 1-isomorphisms $\mathcal{A}_1, \mathcal{A}_2 : \mathcal{G} \rightarrow \mathcal{H}$. Notice that $L_i \otimes \mathcal{A}_i$ is a 1-isomorphism which consists of the line bundle $L_i \otimes \mathcal{A}_i$ over Z_i , where the line bundle \mathcal{A}_i over Z_i comes from the structure of the 1-isomorphism \mathcal{A}_i , and L_i is pulled back along the projection $Z_i \rightarrow M$. To see that (2-15) is injective, it is enough to note that if two isomorphisms become equal when pulled back along a surjective map, they must have been equal before.

To see that (2-15) is surjective, let an element on the right hand side be represented by isomorphisms $\phi : L_1 \otimes \mathcal{A}_1 \rightarrow L_2 \otimes \mathcal{A}_2$ and $\varphi : \mathcal{A}_1 \rightarrow \mathcal{A}_2$; we may assume over the same manifold W . Then, $\phi \otimes \varphi^{*-1}$ is after canonical identifications an isomorphism of line bundles $L_1 \rightarrow L_2$ over W . The axioms (2M) for ψ and φ combine to the statement that $\phi \otimes \varphi^{*-1}$ represents a 2-isomorphism, namely a morphism in the category $\mathbf{End}(\mathcal{I}_0)$, and hence descends by Theorem 2.4.1 to an isomorphism $\lambda : L_1 \rightarrow L_2$ of line bundles over M . By construction, the image of (λ, φ) is (ϕ, φ) , this is just element we have started with.

Finally, we show that the functor (2-14) is essentially surjective. Given two 1-isomorphisms $\mathcal{A}, \mathcal{B} : \mathcal{G} \rightarrow \mathcal{H}$, we use the functor D from Theorem 2.4.1 and find isomorphic stable isomorphisms $\mathcal{A}', \mathcal{B}'$ which consist of line bundles A and B over the fibre product $p : P \rightarrow M$ of the surjective submersions of the two bundle gerbes, and of isomorphisms α and β of line bundles over $P^{[2]}$. Now we extend the line bundle $A \otimes B^*$ over P to an object $(A \otimes B^*, \chi)$ in the descent category $\mathbf{Des}(\mathcal{Bun}, p)$ for the surjective submersion p and the sheaf of groupoids \mathcal{Bun} defined in the previous section. The isomorphism

$$\chi : p_1^*(A \otimes B^*) \rightarrow p_2^*(A \otimes B^*)$$

of line bundles over $P^{[2]}$ is defined by

$$\begin{aligned} \chi : p_1^*(A \otimes B^*) &\cong (p_1^*A \otimes L') \otimes (L'^* \otimes p_1^*B^*) \\ &\quad \downarrow \alpha^{-1} \otimes \beta^* \\ &(L \otimes p_2^*A) \otimes (p_2^*B^* \otimes L^*) \cong p_1^*(A \otimes B^*) \end{aligned}$$

Using axiom (1M2) for α and β one can show that χ satisfies the cocycle condition $p_{13}^*\chi = p_{23}^*\chi \circ p_{12}^*\chi$ of isomorphisms of line bundles over $P^{[3]}$.

Hence we obtain a line bundle N over M together with an isomorphism $\varphi : p^*N \rightarrow A \otimes B^*$ in the category $\mathbf{Des}(\mathcal{Bun}, p)$. Now, $N \otimes \mathcal{B}$ is a 1-isomorphism with the line bundle $N \otimes B$ that is isomorphic by φ to A . The condition the

morphism φ in $\mathcal{D}\text{es}(\mathcal{B}un, p)$ shows that this is a 2-isomorphism in $\mathcal{I}\text{so}(\mathcal{G}, \mathcal{H})$. ■

If one reduces a category to its skeleton, a monoidal category \mathfrak{C} gives rise to a monoid. Accordingly, any module category over \mathfrak{C} becomes a set with an action of this monoid. This set will be a torsor, if the module category is a torsor category. In our example, we obtain

Corollary 2.5.5. *The set of equivalence classes of 1-isomorphism between two fixed bundle gerbes over M is a torsor over the group $\text{Pic}_0(M)$ of isomorphism classes of flat line bundles over M .*

With this corollary we have reproduced a well-known fact about isomorphism classes of 1-isomorphisms between bundle gerbes [CJM02, SSW07]. By Theorem 2.5.4 we have lifted this fact from a statement about skeletons to a statement about categories. This will be important in Chapter 4.

2.6 The Čech-Deligne Complex as a 2-Category

We have described in Chapter 1 how to obtain cocycles in the Čech-Deligne double complex from bundle gerbes. By Theorem 2.4.1 we can now derive cochains for arbitrary 1-isomorphisms and 2-isomorphisms: we first go to isomorphic stable isomorphisms and corresponding 2-isomorphisms between those, and then apply the procedure described in Chapter 1.

We have also derived with Theorem 1.3.4 a bijective correspondence between the cohomology classes represented by these cocycles and 1-isomorphism classes of bundle gerbes. In this section we describe how this bijection can be interpreted as a bijection between the skeletons of two 2-categories. Then we lift this bijection between the skeletons to an equivalence of these 2-categories.

Depending on an open cover \mathfrak{V} of a smooth manifold M , we define a strictly associative 2-category $\mathcal{D}\text{el}^2(\mathfrak{V})$ whose objects are cocycles $\xi \in \text{Tot}^2(\mathfrak{V}, \mathcal{D}(2))$. The Hom-category $\mathfrak{H}\text{om}(\xi, \xi')$ is defined as follows: its objects $\beta : \xi \rightarrow \xi'$ are cochains $\beta \in \text{Tot}^1(\mathfrak{V}, \mathcal{D}(2))$ with the property $\xi' = \xi + D\beta$, and a morphism $\alpha : \beta \Rightarrow \beta'$ is a cochain $\alpha \in \text{Tot}^0(\mathfrak{V}, \mathcal{D}(2))$ with $\beta' = \beta + D\alpha$. The identity morphism id_β is the trivial cochain $\alpha = 1$, and the composition in the category $\mathfrak{H}\text{om}(\xi, \xi')$ is given by the product $\alpha \cdot \alpha'$. The composition functor

$$\circ : \mathfrak{H}\text{om}(\xi_2, \xi_3) \times \mathfrak{H}\text{om}(\xi_1, \xi_2) \rightarrow \mathfrak{H}\text{om}(\xi_1, \xi_3)$$

of the 2-category $\mathcal{D}\text{el}^2(\mathfrak{V})$ is defined by

$$\begin{array}{c} \begin{array}{ccc} & \beta_2 & \\ \xi_2 & \begin{array}{c} \curvearrowright \\ \alpha_2 \\ \curvearrowleft \end{array} & \xi_3 \\ & \beta'_2 & \end{array} & \circ & \begin{array}{ccc} & \beta_1 & \\ \xi_1 & \begin{array}{c} \curvearrowright \\ \alpha_1 \\ \curvearrowleft \end{array} & \xi_2 \\ & \beta'_1 & \end{array} & := & \begin{array}{ccc} & \beta_2 + \beta_1 & \\ \xi_1 & \begin{array}{c} \curvearrowright \\ \alpha_2 \cdot \alpha_1 \\ \curvearrowleft \end{array} & \xi_3 \\ & \beta'_2 + \beta'_1 & \end{array} \end{array} ,$$

so, the sum $\beta_1 + \beta_2$ on 1-morphisms, and the product $\alpha_1 \cdot \alpha_2$ on 2-morphisms. The identity 1-morphism id_ξ associated to an object ξ is the trivial cochain $\beta = 0$, and the natural 2-isomorphisms are $\rho_\beta = \lambda_\beta = 1$. This way it is obvious that the two axioms (2C1) and (2C1) of a strictly associative 2-category are satisfied.

Now we are going to relate the 2-category $\mathcal{D}\text{el}^2(\mathfrak{Y})$ to the 2-category $\mathfrak{B}\mathcal{G}\text{rb}(M)$ of bundle gerbes over M . Notice that the extraction of cocycles from bundle gerbes and cochains of their 1-morphisms depends on choices of sections; thus we do not expect a *canonical* 2-functor in this direction. However, the reconstruction of geometric objects from given cochains leads to a canonical 2-functor

$$\mathcal{C}on : \mathcal{D}\text{el}^2(\mathfrak{Y}) \rightarrow \mathfrak{B}\mathcal{G}\text{rb}(M)$$

between our two 2-categories. To define $\mathcal{C}on$ we recall the construction of the bundle gerbe $\mathcal{C}on(\xi)$ from a given cocycle ξ that we have described in the proof of Theorem 1.3.6. This construction obeys $\mathcal{C}on(-\xi) = \mathcal{C}on(\xi)^*$, and we have a canonical 1-isomorphism

$$\text{can} : \mathcal{C}on(\xi_1 + \xi_2) \rightarrow \mathcal{C}on(\xi_1) \otimes \mathcal{C}on(\xi_2)$$

induced from the morphism $M_{\mathfrak{Y}} \rightarrow M_{\mathfrak{Y}}^{[2]} : V_i \mapsto V_i \cap V_i$ of surjective submersions by Lemma 1.2.3. We recall further that we have constructed a trivialization $\mathcal{T}_\beta : \mathcal{C}on(\xi) \rightarrow \mathcal{I}_0$ associated to a cochain β with $\xi + D\beta = 0$. From its definition it is clear that a cochain $\alpha \in \text{Tot}^0(\mathfrak{Y}, \mathcal{D}(2))$ with $\beta' = \beta + D\alpha$ defines a 2-isomorphism $\tau_\alpha : \mathcal{T}_\beta \Rightarrow \mathcal{T}_{\beta'}$.

To define the 2-functor $\mathcal{C}on$ on 1-morphisms and 2-morphisms, we use the trivializations \mathcal{T}_β and the 2-isomorphisms τ_α . If $\beta : \xi \rightarrow \xi'$ is a 1-morphism in $\mathcal{D}\text{el}^2(\mathfrak{Y})$, we define its image $\mathcal{C}on(\beta)$ by

$$\begin{array}{ccc} \mathcal{C}on(\xi) & \xrightarrow{\text{id}_{\mathcal{C}on(\xi)} \otimes \mathcal{D}_{\mathcal{C}on(\xi')}^{-1}} & \mathcal{C}on(\xi) \otimes \mathcal{C}on(\xi')^* \otimes \mathcal{C}on(\xi') \\ & & \downarrow \text{can}^{-1} \otimes \text{id}_{\mathcal{C}on(\xi')} \\ & & \mathcal{C}on(\xi - \xi') \otimes \mathcal{C}on(\xi') \xrightarrow{\mathcal{T}_\beta \otimes \text{id}_{\mathcal{C}on(\xi')}} \mathcal{C}on(\xi'), \end{array}$$

where we have used the duality 1-isomorphism and the monoidal structure on the 2-category $\mathfrak{B}\mathcal{G}\text{rb}(M)$ we have introduced in §1.2 and §2.5, respectively. The definition seems to be quite inconvenient on the first view, but the construction of a 1-isomorphism from a given cochain is an involved procedure, see also [Ste00]. It remains to define the image $\mathcal{C}on(\alpha) : \mathcal{C}on(\beta) \Rightarrow \mathcal{C}on(\beta')$ of a 2-morphism $\alpha : \beta \Rightarrow \beta'$. Now we can even profit from the above definition of the 1-isomorphism $\mathcal{C}on(\beta)$: we just set

$$\mathcal{C}on(\alpha) := (\text{id}_{\mathcal{C}on(\xi)} \otimes \text{id}_{\mathcal{D}_{\mathcal{C}on(\xi')}^{-1}}) \circ (\text{id}_{\text{can}^{-1}} \otimes \text{id}_{\mathcal{C}on(\xi')}) \circ (\tau_\alpha \otimes \text{id}_{\mathcal{C}on(\xi')}).$$

Now we have to show that the assignment Con we have defined is a 2-functor. Unfortunately, this 2-functor is not strict: it comes with non-trivial 2-isomorphisms

$$u_\xi : Con(\text{id}_\xi) \Rightarrow \text{id}_{Con(\xi)} \quad \text{and} \quad c_{\beta_1, \beta_2} : Con(\beta_2 + \beta_1) \Rightarrow Con(\beta_2) \circ Con(\beta_1)$$

for every object ξ in $\mathfrak{Del}^2(\mathfrak{Y})$ and every pair β_1, β_2 of 1-morphisms, respectively. These 2-isomorphisms are called *unitors* and *compositors* of the 2-functor Con . Their definition is straightforward and uses the multiplication of the reconstructed bundle gerbes. It follows then from its associativity axiom (G1) that all consistency conditions are satisfied: the compositor c_{β_1, β_2} is associative, respects the horizontal composition, and is compatible with the unitor. Finally, the vertical composition is respected; this follows from the identity $\tau_{\alpha' \cdot \alpha} = \tau_{\alpha'} \bullet \tau_\alpha$ for the 2-morphism τ_α . This way, the assignment Con defines a 2-functor.

Since not every bundle gerbe is 1-isomorphic to a bundle gerbe whose surjective submersion comes from the fixed open cover \mathfrak{Y} , we can not expect that the functor Con is an equivalence of 2-categories. To achieve such an equivalence, we define a sub-2-category $\mathfrak{BGrb}(\mathfrak{Y})$ of $\mathfrak{BGrb}(M)$ consisting only of those bundle gerbes whose surjective submersion admits sections defined on the open sets of \mathfrak{Y} . Obviously, the image of the 2-functor Con is contained in $\mathfrak{BGrb}(\mathfrak{Y})$.

Proposition 2.6.1. *For a good open cover \mathfrak{Y} , the 2-functor*

$$Con : \mathfrak{Del}^2(\mathfrak{Y}) \rightarrow \mathfrak{BGrb}(\mathfrak{Y})$$

is an equivalence of 2-categories.

Proof. We prove that the extraction of cocycles and cochains we have described in Chapter 1 defines a (non-canonical) inverse functor. For this purpose, we fix choices of sections needed to extract cocycles from all bundle gerbes in $\mathfrak{BGrb}(\mathfrak{Y})$, where we choose the sections for the reconstructed bundle gerbes $Con(\xi)$ as described in the proof of Theorem 1.3.6 so that we obtain the cocycle ξ back. For each pair of bundle gerbes, we fix choices for the sections needed to extract cochains for all 1-isomorphisms between these two bundle gerbes, where we choose those for reconstructed 1-isomorphisms $Con(\beta)$ in such a way that we get the cochain β back. Then, we reproduce the cochain α for every reconstructed 2-isomorphism $Con(\alpha)$. These assignments define a *strict* 2-functor

$$Ex : \mathfrak{BGrb}(\mathfrak{Y}) \rightarrow \mathfrak{Del}^2(\mathfrak{Y}),$$

with the properties $Ex(\text{id}_G) = \text{id}_{Ex(G)} = 0$ and $Ex(\mathcal{A}' \circ \mathcal{A}) = Ex(\mathcal{A}') + Ex(\mathcal{A})$. By construction, it has the left inverse property $Ex \circ Con = \text{id}_{\mathfrak{Del}^2(\mathfrak{Y})}$.

Conversely, the composite $Con \circ Ex$ is not equal to the identity 2-functor on $\mathfrak{BGrb}(\mathfrak{Y})$ but only equivalent; there is a *pseudonatural equivalence*

$$\chi : \mathcal{C}on \circ \text{Ex} \Rightarrow \text{id}_{\mathfrak{B}\mathcal{G}\text{rb}(\mathfrak{Y})}.$$

It assigns to every object \mathcal{G} of $\mathfrak{B}\mathcal{G}\text{rb}(\mathfrak{Y})$ a 1-isomorphism $\chi(\mathcal{G}) : \mathcal{C}on(\text{Ex}(\mathcal{G})) \rightarrow \mathcal{G}$ and to every 1-isomorphism $\mathcal{A} : \mathcal{G} \rightarrow \mathcal{G}'$ in $\mathfrak{B}\mathcal{G}\text{rb}(\mathfrak{Y})$ a 2-isomorphism

$$\chi(\mathcal{A}) : \chi(\mathcal{G}') \circ \mathcal{C}on(\text{Ex}(\mathcal{A})) \Rightarrow \mathcal{A} \circ \chi(\mathcal{G})$$

in a way that is compatible with the composition of 1-isomorphisms and the 2-isomorphisms. Here, the 1-isomorphism $\chi(\mathcal{G})$ is defined in the following way: we use $Z := M_{\mathfrak{Y}} \times_M Y$ and the line bundle $A := \tilde{s}^*L$ over Z , where $\tilde{s} : Z \rightarrow Y^{[2]}$ is in the first component the morphism $s : M_{\mathfrak{Y}} \rightarrow Y$ of surjective submersions chosen to extract local data, and the identity in the second component of Z . Let $\mathbb{1}_A$ be the line bundle of $\mathcal{C}on(\text{Ex}(\mathcal{G}))$ over $M_{\mathfrak{Y}}^{[2]}$ which is clearly isomorphic to s^*L . The composite of this isomorphism with the isomorphism $s^*\lambda$ over $Z^{[2]}$, where λ comes from the definition of the identity 1-isomorphism in §1.3, defines an isomorphism α in such a way that (A, α) gives the 1-isomorphism $\chi(\mathcal{G})$. The 2-isomorphism $\chi(\mathcal{A})$ has to be constructed from the multiplications μ and μ' of the two bundle gerbes, and the isomorphism α of the 1-isomorphism \mathcal{A} . ■

By construction, the skeleton of the 2-category $\mathfrak{D}\mathfrak{e}\mathfrak{l}^2(\mathfrak{Y})$ is $H^2(\mathfrak{Y}, \mathcal{D}(2))$, which is in turn isomorphic to $H^2(M, \mathcal{D}(2))$ if \mathfrak{Y} is a good open cover. Then, Proposition 2.6.1 reproduces in particular Theorem 1.3.6 on the level of skeletons. The refinement we have achieved here will be important in Chapter 5, where we are going to use cohomological calculations to classify equivariant bundle gerbes; those consist of a bundle gerbe, certain 1-isomorphisms and certain 2-isomorphisms.

Chapter 3

Algebraic Structure for Bundle Gerbes I: Modules and Bimodules

There are two natural algebraic structures in two-dimensional conformal field theories: conformally invariant boundary conditions and topological defect lines. It is natural to ask if these structures can also be found in Wess-Zumino-Witten models or, more general, in sigma models with Wess-Zumino term. Such target space interpretations of conformally invariant boundary conditions and topological defect lines are also relevant for string theory. In case of boundary conditions, the corresponding structures are so-called D-branes, which we review in the first section of this chapter. The structure corresponding to topological defect lines is introduced in this thesis and called bi-brane; this is the subject of the remaining sections of this chapter.

From a purely mathematical point of view, D-branes and bi-branes are structures which allow to extend the holonomy for closed oriented surfaces from Chapter 1 to oriented surfaces with defect lines.

3.1 D-Branes, relative Cohomology and Gerbe Modules

The study of D-branes in string theory is about open strings moving through a target space M while its endpoints are restricted to a submanifold Q of M [Pol]. In the description of sigma models by maps $\phi : \Sigma \rightarrow M$ this amounts to consider worldsheets Σ with boundary $\partial\Sigma$ such that $\phi(\partial\Sigma) \subset Q$. We recall from §1.6 that the Feynman amplitude in a sigma model for oriented worldsheets is given by

$$\mathcal{A}_{g,\mathcal{G}}(\phi, \Sigma) = \exp(2\pi i S_g^{\text{kin}}(\phi, \Sigma)) \cdot \mathcal{A}_{\mathcal{G}}^{\text{WZ}}(\phi, \Sigma).$$

The kinetic term $S_g^{\text{kin}}(\phi)$ has been defined as an integral of a 2-form over Σ , which is still well-defined when Σ has a boundary. The second term, however, defined as $\mathcal{A}_{\mathcal{G}}^{\text{WZ}}(\phi, \Sigma) := \text{Hol}_{\mathcal{G}}(\phi, \Sigma)$, is no longer well-defined in this situation: the integral of the closed 2-form $\rho_2 - \rho_1$ with integral class, which makes the difference between two choices of trivializations in the definition of oriented

surface holonomy, gives no longer an integer. More precisely, a boundary term emerges which has to be compensated to achieve a holonomy independent of the choice of the trivialization. The definition of this compensating term involves the choice of additional structure on the submanifold Q .

To find this additional structure, it is helpful to discuss first topologically trivial sigma models, defined by a 2-connected smooth Riemannian manifold M and a closed 3-form $H \in \Omega^3(M)$ with integral class. We recall from §1.6 that in this situation the Feynman amplitude $\mathcal{A}_{\mathcal{G}}^{\text{WZ}}(\phi, \Sigma)$ of a map $\phi : \Sigma \rightarrow M$ can be defined by choosing a three-dimensional manifold B with $\partial B = \Sigma$ and an extension $\Phi : B \rightarrow M$ of ϕ , in such a way that $\mathcal{A}_{\mathcal{G}}^{\text{WZ}}(\phi, \Sigma)$ is the exponential of the Wess-Zumino term

$$S_H^{\text{WZ}}(\Phi, B) = \int_B \Phi^* H.$$

For these topologically trivial sigma models, the additional structure on the submanifold Q is known to be a 2-form $\omega \in \Omega^2(Q)$ with the property that $d\omega = H|_Q$. The following definition of the Feynman amplitude is given [Gaw].

We assume for simplicity that Σ has only one boundary component, which is then diffeomorphic to S^1 . Let D be the two-dimensional disc glued along its boundary on Σ , so that we obtain a three-dimensional manifold B whose boundary is $\partial B = \Sigma \cup D$. We assume that there exists an extension $\Phi : B \rightarrow M$ of the map ϕ , which sends D into the submanifold Q . Such an extension exists, if Q is connected and simply-connected, additional to the condition that M is 2-connected. Then, the Wess-Zumino term is given by

$$S_{H,\omega}^{\text{WZ}}(\Phi, B) := \int_B \Phi^* H - \int_D \Phi^* \omega. \quad (3-1)$$

The well-definedness of the associated Feynman amplitude poses a condition on H and ω ; here it is not sufficient that H is a closed 3-form with integral class. The equations $dH = 0$ and $H|_Q = d\omega$ rather mean that the pair (H, ω) defines a cocycle in the relative de Rham cohomology of the inclusion $Q \hookrightarrow M$ [BT82]. The condition is that the corresponding class in the relative cohomology $H^3(M, Q, \mathbb{R})$ is integral in the sense that it lies in the image of the relative cohomology with integer coefficients [FOS01].

We have learned before that the theory of bundle gerbes is useful and by now indispensable to deal with topologically non-trivial sigma models. Accordingly, we have to adjust the definition of a D-Brane to this more general situation. It is still build up on a submanifold Q . In a first attempt [GR02], the 2-form ω was replaced by a trivialization

$$\mathcal{T} : \mathcal{G}|_Q \rightarrow \mathcal{I}_\omega$$

of the bundle gerbe \mathcal{G} of the sigma model restricted to Q . Notice that this reproduces in particular the old condition $H|_Q = d\omega$ for the curvature H of the

bundle gerbe \mathcal{G} . Later it was recognized [Kap00, Gaw05] that a trivialization, i.e. a 1-isomorphism, is too restrictive. In fact a D-brane for a certain bundle gerbe over $\mathrm{SO}(4n)/\mathbb{Z}_2$ was found that does not admit a 1-isomorphism but only a weaker structure – a bundle gerbe module.

To describe bundle gerbe modules in a more convenient way than it has so far been done in the literature, we use the 1-morphisms of the new 2-category $\mathfrak{BGrb}(M)$ of bundle gerbes over M we have introduced in Chapter 2.

Definition 3.1.1. *Let \mathcal{G} be a bundle gerbe over M . A left \mathcal{G} -module is a 1-morphism $\mathcal{E} : \mathcal{G} \rightarrow \mathcal{I}_\omega$, and a right \mathcal{G} -module is a 1-morphism $\mathcal{F} : \mathcal{I}_\omega \rightarrow \mathcal{G}$.*

Let us compare this definition with the original definition of (left) bundle gerbe modules in [BCM⁺02], that does not make use of 2-categorical structures. Assume – by Theorem 2.4.1 without loss of generality – that a left \mathcal{G} -module $\mathcal{E} : \mathcal{G} \rightarrow \mathcal{I}_\omega$ has the surjective submersion id_P with $P \cong Y$. Then, it consists of a vector bundle E over Y and of an isomorphism $\epsilon : L \otimes \pi_2^* E \rightarrow \pi_1^* E$ of vector bundles over Y ^[2] which satisfies

$$\pi_{13}^* \epsilon \circ (\mu \otimes \mathrm{id}) = \pi_{23}^* \epsilon \circ \pi_{12}^* \epsilon$$

by axiom (1M2). The curvature of E is restricted by axiom (1M1) to

$$\frac{1}{n} \mathrm{tr}(\mathrm{curv}(E)) = \pi^* \omega - C$$

with n the rank of E . In [BCM⁺02] a bundle gerbe module was defined as a pair (E, ϵ) with the above properties, so that the two definitions coincide. The purpose of [BCM⁺02] was to obtain a geometric realization of twisted K-Theory: a \mathcal{G} -module defines a class in degree zero of the K-theory of M twisted by the Dixmier-Douady class $dd(\mathcal{G}) \in H^3(M, \mathbb{Z})$.

The rank of the vector bundle of the 1-morphism is also called the *rank* of the \mathcal{G} -module. Let us have a look on the local description of gerbe modules. Let (g, A, B) be a cocycle for the bundle gerbe \mathcal{G} with respect to an open cover $\mathfrak{V} = \{V_i\}_{i \in I}$ of M . Similarly to cochains for a 1-isomorphism it is possible to extract local expressions from a 1-morphism, in particular of a bundle gerbe module [Gaw05]

$$\mathcal{E} : \mathcal{G} \rightarrow \mathcal{I}_\omega.$$

These are smooth functions

$$G_{ij} : V_i \cap V_j \rightarrow \mathrm{U}(n)$$

on double intersections, where n is the rank of the gerbe module, and $\mathfrak{u}(n)$ -valued 1-forms P_i on each open set V_i . Like a 1-isomorphism, a 1-morphism relates a cocycle (g, A, B) for the bundle gerbe \mathcal{G} to the one of the trivial bundle gerbe \mathcal{I}_ω by the following equations:

$$\begin{aligned}
1 &= g_{ijk} \cdot G_{ij} \cdot G_{jk} \cdot G_{ik}^{-1} \\
0 &= A_{ij} + P_j - \text{Ad}_{G_{ij}}(P_i) - \frac{1}{i} G_{ij}^{-1} dG_{ij} \\
\omega &= B_i + dP_i
\end{aligned}$$

In these equations, we identify $U(1)$ with the diagonal subgroup of $U(n)$, and correspondingly the Lie algebra of $U(1)$ with a subalgebra of $\mathfrak{u}(n)$. Notice that if the bundle gerbe \mathcal{G} is the trivial bundle gerbe \mathcal{I}_0 and $(g, A, B) = (1, 0, 0)$, the three equations would be the usual cocycle conditions for a hermitian vector bundle with unitary connection of curvature ω . For a non-trivial bundle gerbe, these cocycle conditions become twisted – for this reason, gerbe modules are also known as *twisted vector bundles*.

The definition of bundle gerbe modules as 1-morphisms makes clear that left and right \mathcal{G} -modules form categories $\mathfrak{LMod}(\mathcal{G})$ and $\mathfrak{RMod}(\mathcal{G})$, which are both module categories over the category of vector bundles over M by Proposition 2.5.2. This is useful to see for instance that a 1-isomorphism $\mathcal{A} : \mathcal{G} \rightarrow \mathcal{G}'$ defines equivalences of categories

$$\mathfrak{LMod}(\mathcal{G}) \cong \mathfrak{LMod}(\mathcal{G}') \quad \text{and} \quad \mathfrak{RMod}(\mathcal{G}) \cong \mathfrak{RMod}(\mathcal{G}'), \quad (3-2)$$

and that there are equivalences between left modules of \mathcal{G} and right modules of \mathcal{G}^* (and vice versa), by taking duals of the respective 1-morphisms. Moreover, for a trivial bundle gerbe \mathcal{I}_ρ the categories $\mathfrak{LMod}(\mathcal{I}_\rho)$ and $\mathfrak{RMod}(\mathcal{I}_\rho)$ become canonically equivalent to the category $\mathfrak{Bun}(M)$ of vector bundles over M via the equivalence Bun from Proposition 2.4.5. We combine this result with the equivalences (3-2), applied to a trivialization $\mathcal{T} : \mathcal{G} \rightarrow \mathcal{I}_\rho$ of a bundle gerbe \mathcal{G} over M . In detail, a left \mathcal{G} -module $\mathcal{E} : \mathcal{G} \rightarrow \mathcal{I}_\omega$ first becomes a left \mathcal{I}_ρ -module

$$\mathcal{E} \circ \mathcal{T}^{-1} : \mathcal{I}_\rho \rightarrow \mathcal{I}_\omega$$

which in turn defines the vector bundle $E := \text{Bun}(\mathcal{E} \circ \mathcal{T}^{-1})$ over M . The same applies to right \mathcal{G} -modules $\mathcal{F} : \mathcal{I}_\omega \rightarrow \mathcal{G}$ which defines a vector bundle $\bar{E} := \text{Bun}(\mathcal{T} \circ \mathcal{F})$ over M . This is a generalization of Corollary 2.4.6, where we have seen that to trivializations $\mathcal{T}_1 : \mathcal{G} \rightarrow \mathcal{I}_{\rho_1}$ and $\mathcal{T}_2 : \mathcal{G} \rightarrow \mathcal{I}_{\rho_2}$ define a line bundle over M .

Definition 3.1.2 (Gawędzki [Gaw05]). *Let \mathcal{G} be a bundle gerbe over M . A \mathcal{G} -D-brane is a submanifold Q of M together with a left $\mathcal{G}|_Q$ -module*

$$\mathcal{E} : \mathcal{G}|_Q \rightarrow \mathcal{I}_\omega.$$

The 2-form ω on Q is called the curvature, and the submanifold Q is called the world volume of the D-brane.

The gerbe module \mathcal{E} of a \mathcal{G} -D-brane will produce a term which compensates the changes of the 2-form ρ of a trivialization on the boundary. We consider a configuration like shown in Figure 3.1, and give the following definition of holonomy.

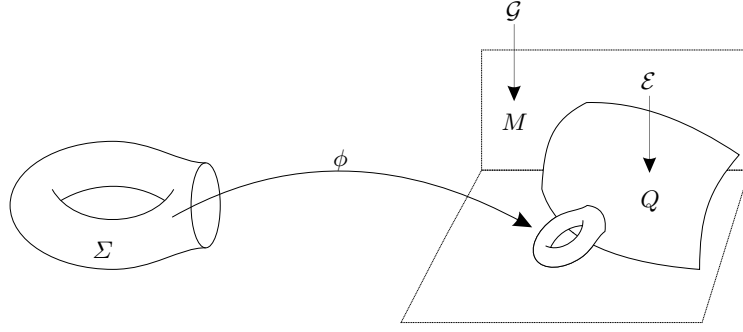

Figure 3.1: A surface is mapped into a target space with bundle gerbe \mathcal{G} , in such a way that its boundary is mapped into the submanifold Q with bundle gerbe module \mathcal{E} .

Definition 3.1.3 ([CJM02, Wal07]). Let \mathcal{G} be a bundle gerbe over M with \mathcal{G} - D -brane (Q, \mathcal{E}) and let $\phi : \Sigma \rightarrow M$ be a smooth map from a compact oriented surface Σ with boundary to M , such that $\phi(\partial\Sigma) \subset Q$. Let

$$\mathcal{T} : \phi^*\mathcal{G} \rightarrow \mathcal{I}_\rho$$

be any trivialization of the pullback bundle gerbe $\phi^*\mathcal{G}$ and let

$$E := \text{Bun}(\phi^*\mathcal{E} \circ \mathcal{T}^{-1}|_{\partial\Sigma})$$

be the associated vector bundle over $\partial\Sigma$. The oriented D -brane holonomy is defined as

$$\text{Hol}_{\mathcal{G}, \mathcal{E}}(\phi, \Sigma) := \exp\left(2\pi i \int_{\Sigma} \rho\right) \cdot \text{tr}(\text{Hol}_E(\partial\Sigma)) \in \mathbb{C}.$$

To show that this definition does not depend on the choice of the trivialization, we use the 2-categorical formalism we have developed in this thesis: for another trivialization $\mathcal{T}' : \phi^*\mathcal{G} \rightarrow \mathcal{I}_{\rho'}$ and the respective vector bundle $E' := \text{Bun}(\mathcal{E} \circ \mathcal{T}'^{-1})$ we find by Proposition 2.4.5 (i)

$$E' = \text{Bun}(\mathcal{E} \circ \mathcal{T}'^{-1}) \cong \text{Bun}(\mathcal{E} \circ \mathcal{T}^{-1} \circ \mathcal{T} \circ \mathcal{T}'^{-1}) = E \otimes \text{Bun}(\mathcal{T} \circ \mathcal{T}'^{-1}).$$

Because isomorphic vector bundles have the same holonomies, and the line bundle $\text{Bun}(\mathcal{T} \circ \mathcal{T}'^{-1})$ has curvature $\rho - \rho'$ we obtain

$$\text{tr}(\text{Hol}_{E'}(\partial\Sigma)) = \text{tr}(\text{Hol}_E(\partial\Sigma)) \cdot \exp\left(2\pi i \int_{\Sigma} \rho - \rho'\right).$$

This shows the independence of oriented D -brane holonomy of the choice of the trivialization.

Proposition 3.1.4. *Let \mathcal{G} be a bundle gerbe over M and (Q, \mathcal{E}) be a \mathcal{G} -D-brane of curvature ω . Oriented D-brane holonomy has the following properties:*

- (i) *for a closed oriented surface Σ and any smooth map $\phi : \Sigma \rightarrow M$, oriented D-brane holonomy reduces to ordinary oriented holonomy from Definition 1.5.2,*

$$\mathrm{Hol}_{\mathcal{G}, \mathcal{E}}(\phi, \Sigma) = \mathrm{Hol}_{\mathcal{G}}(\phi, \Sigma).$$

- (ii) *if \mathcal{E}' is another left $\mathcal{G}|_Q$ -module, and there exists a 2-isomorphism $\mathcal{E}_i \Rightarrow \mathcal{E}'_i$,*

$$\mathrm{Hol}_{\mathcal{G}, \mathcal{E}}(\phi, \Sigma) = \mathrm{Hol}_{\mathcal{G}, \mathcal{E}'}(\phi, \Sigma)$$

for every oriented surface Σ and every smooth map $\phi : \Sigma \rightarrow M$ with $\partial\Sigma \subset Q$; similarly, if \mathcal{G}' is another bundle gerbe over M , and $\mathcal{A} : \mathcal{G}' \rightarrow \mathcal{G}$ is an isomorphism of bundle gerbes,

$$\mathrm{Hol}_{\mathcal{G}, \mathcal{E}}(\phi, \Sigma) = \mathrm{Hol}_{\mathcal{G}', \mathcal{E} \circ \mathcal{A}}(\phi, \Sigma).$$

- (iii) *if B is a smooth oriented three-dimensional manifold with boundary, and ∂B is diffeomorphic to a surface $\Sigma \cup D$ obtained by gluing a disc D on a surface Σ with boundary, for any smooth map $\Phi : B \rightarrow M$ with $\Phi|_D \subset Q$ we have*

$$\mathrm{Hol}_{\mathcal{G}, \mathcal{E}}(\Phi|_{\Sigma}, \Sigma) = \exp 2\pi i \left(\int_B \Phi^* \mathrm{curv}(\mathcal{G}) - \int_D \Phi^* \omega \right).$$

Proof. The only non-trivial part is (iii). By dimensional reasons we can choose a trivialization $\mathcal{T} : \mathcal{G}|_{\partial B} \rightarrow \mathcal{I}_\rho$ of the bundle gerbe over ∂B , thus producing a vector bundle E over D of curvature

$$\frac{1}{n} \mathrm{tr}(\mathrm{curv}(E)) = (\Phi^* \omega - \rho)|_D.$$

By definition of oriented D-brane holonomy, we have

$$\mathrm{Hol}_{\mathcal{G}, \mathcal{E}}(\Phi|_{\Sigma}, \Sigma) = \exp \left(2\pi i \int_{\Sigma} \rho \right) \cdot \mathrm{tr}(\mathrm{Hol}_E(\partial\Sigma)).$$

The first term can be written as an integral over ∂B minus an integral over D , where the first is by Theorem 1.5.4

$$\exp \left(2\pi i \int_{\partial B} \rho \right) = \mathrm{Hol}_{\mathcal{G}}(\Phi|_{\partial B}, \partial B) = \exp \left(2\pi i \int_B \Phi^* \mathrm{curv}(\mathcal{G}) \right).$$

The second term can be written as

$$\mathrm{tr}(\mathrm{Hol}_E(\partial\Sigma)) = \mathrm{tr}(\mathrm{Hol}_E(\overline{\partial D})) = \exp \left(2\pi i \int_D -\Phi^* \omega + \rho \right).$$

Both parts together give the claim. ■

It follows in particular, that the pairing of any smooth relative singular 3-chain (B, D) in (M, Q) with the relative de Rham cocycle (H, ω) gives an integer, which means

Corollary 3.1.5. *If \mathcal{G} is a bundle gerbe over M of curvature H , and (Q, \mathcal{E}) is a \mathcal{G} -D-brane of curvature ω , the pair (H, ω) defines a cocycle in the relative de Rham cohomology of (M, Q) with integral class.*

Recall that such a relative de Rham cocycle with integral class appeared in the definition of the Wess-Zumino term in the topologically trivial situation we have discussed at the beginning of this section. Moreover, by Proposition 3.1.4 (iii), the oriented D-brane holonomy reproduces the Wess-Zumino term (3-1):

$$\text{Hol}_{\mathcal{G}, \mathcal{E}}(\phi, \Sigma) = \exp\left(2\pi i S_{H, \omega}^{\text{WZ}}(\Phi, B)\right),$$

with the same advantages as discussed for oriented surface holonomy in §1.6. Thus, oriented D-brane holonomy is the appropriate way to define Wess-Zumino terms for general sigma models for worldsheets with boundary, as we will do §3.4.

As a last point, we have a look on the oriented D-brane holonomy in terms of local expressions. We use a triangulation of Σ which is subordinated to the open cover of M just like we did in §1.5 to derive the formula of the local expression of the holonomy for a closed oriented surface. Splitting of the integral of the 2-form ρ over Σ , which build the first factor of $\text{Hol}_{\mathcal{G}, \mathcal{E}}(\phi, \Sigma)$, leads exactly to formula (1-13). It has to be amended by the local expression

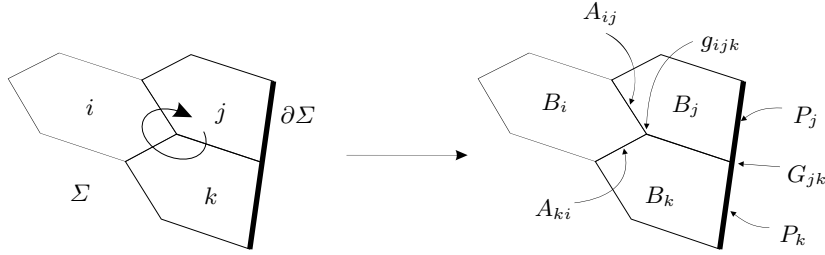

Figure 3.2: The triangulation of the surface Σ is decorated by local data as in Figure 1.3, completed by the local 1-forms P_i and the functions G_{ij} coming from the bundle gerbe module, which are placed along the boundary $\partial\Sigma$.

for the second factor, which is the holonomy of the vector bundle E around the boundary of Σ . The latter is similar to the local expression for the holonomy of a line bundle around a loop we also gave in §1.5, namely

$$\text{tr}(\text{Hol}_E(\partial\Sigma)) = \text{tr} \text{P} \left\{ \prod_{e \in \Delta \cap \partial\Sigma} \exp\left(2\pi i \int_e \phi^* P_{i(e)}\right) \cdot \prod_{v \in \partial e} G_{i(e), i(v)}^{\epsilon(e, v)} \right\}.$$

The only difference is that the terms now live in the non-abelian group $U(n)$ and have to be ordered with respect to the induced orientation on $\partial\Sigma$, which is indicated by the path-ordering operator P . The cyclic property of the trace assures that it does not depend on a specific point from where one starts multiplying terms. The complete picture where the local data is used is shown in Figure 3.2.

3.2 Bi-Branes I: Birelative Cohomology

In the previous section we have defined oriented D-brane holonomy, i.e. holonomy for oriented surfaces with boundary. Now we consider surfaces with defect lines.

Definition 3.2.1. *Let Σ be an oriented connected compact surface. A defect line S in Σ is the image of an embedding $f : S^1 \rightarrow \Sigma$.*

Note that the submanifold $\Sigma \setminus S$ is either connected or has two components. If it has two components Σ_1 and Σ_2 , one of them is distinguished by the fact that the orientation induced on S coincides with the one coming from S^1 along the embedding f , see Figure 3.3.

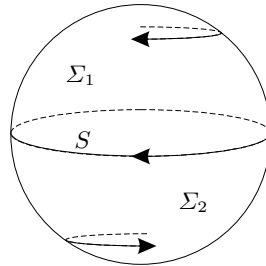

Figure 3.3: A defect line on the 2-sphere.

In general, a surface with several (non-intersecting) defect lines has a number of components Σ_i . The setup to discuss the holonomy of such a surface is to consider smooth maps $\phi_i : \Sigma_i \rightarrow M_i$, one for each component Σ_i , to in general different smooth manifolds M_i , each equipped with a bundle gerbe \mathcal{G}_i . We infer that the definition of this holonomy requires additional structures in the products $M_i \times M_j$ of the manifolds, and we call this additional structure a *bi-brane*.

Analogous to the discussion of D-branes, we gather some motivation from sigma models. In this section we merely consider the simplest situation: a worldsheet with one defect line that separates two topologically trivial sigma models with 2-connected target spaces M_1 and M_2 .

Definition 3.2.2. A *topologically trivial M_1 - M_2 -bi-brane* between two topologically trivial sigma models (M_1, g_1, H_1) and (M_2, g_2, H_2) is a connected and simply connected submanifold Q of $M_1 \times M_2$ together with a 2-form $\varpi \in \Omega^2(Q)$ such that

$$p_1^*H|_Q = p_2^*H|_Q + d\varpi,$$

where p_1 and p_2 are the two projections $p_i : M_1 \times M_2 \rightarrow M_i$.

We denote the two components of the worldsheet by Σ_1 and Σ_2 , and assume without loss of generality $\partial\Sigma_1 = S$ and $\partial\Sigma_2 = \bar{S}$ as equalities of oriented manifolds, where \bar{S} is the manifold S with opposite orientation. Now we consider a pair (ϕ_1, ϕ_2) of maps

$$\phi_i : \Sigma_i \rightarrow M_i$$

such that the image of the combined map

$$\phi_S : S \rightarrow M_1 \times M_2 : s \mapsto (\phi_1(s), \phi_2(s))$$

takes its values in the submanifold Q . We next wish to find the Wess-Zumino term. First, let D be the two-dimensional disc, which we glue along S on Σ_1 and Σ_2 respectively. We obtain two closed surfaces. There exist three-dimensional manifolds B_1 and B_2 such that

$$\partial B_1 = \Sigma_1 \cup_S \bar{D} \quad \text{and} \quad \partial B_2 = \Sigma_2 \cup_S D.$$

Since Q is 1-connected, there exists an extension $\Phi_S : D \rightarrow Q$ of ϕ_S . Combined with ϕ_1 and ϕ_2 , they give maps defined on ∂B_1 and ∂B_2 . Since the manifolds M_i are 2-connected, there also exist extensions $\Phi_1 : B_1 \rightarrow M_1$ and $\Phi_2 : B_2 \rightarrow M_2$. Equipped with such choices, we define the Wess-Zumino term as

$$S_{H_1, H_2, \varpi}^{\text{WZ}}(\Phi_1, \Phi_2, \Phi_S) := \int_{B_1} \Phi_1^* H_1 + \int_{B_2} \Phi_2^* H_2 + \int_D \Phi_S^* \varpi. \quad (3-3)$$

Note that the expression (3-3) depends on the choices of the manifolds B_1 , B_2 and D and of the extensions. However, the ambiguities are under certain conditions integers, so that the associated Feynman amplitude – the exponential of (3-3) – is actually well-defined. This can be shown with the help of a homology theory based on two manifolds M_1 and M_2 and a submanifold $Q \subset M_1 \times M_2$, that we introduce next.

The homology theory we invent is based on singular homology, and can be understood as a generalization of relative homology. Hence we will call it *birelative homology*. The associated cohomology theory with real coefficients can be identified with a cohomology theory based on differential forms, which we call *birelative de Rham cohomology*. These structures enable us to formulate precise conditions under which the Wess-Zumino term (3-3) is well-defined up to integers.

We recall that the (singular) homology $H_k(M)$ of a smooth manifold M is the homology of the singular chain complex with chain groups $\Delta_k(M)$. These are free abelian groups generated by (smooth) k -simplices in M , and come with a boundary operator $\partial : \Delta_k(M) \rightarrow \Delta_{k-1}(M)$. If $Q \subset M_1 \times M_2$ is a submanifold, we define the k th *birelative chain group* of the triple (M_1, M_2, Q) to be

$$\Delta_k(M_1, M_2, Q) := \Delta_k(M_1) \oplus \Delta_k(M_2) \oplus \Delta_{k-1}(Q).$$

Using the projections $p_i : M_1 \times M_2 \rightarrow M_i$, the inclusion map $\iota : Q \hookrightarrow M_1 \times M_2$, and the induced chain maps $(p_i)_*$ and ι_* , we define the homomorphism

$$\begin{aligned} \partial : \Delta_k(M_1, M_2, Q) &\rightarrow \Delta_{k-1}(M_1, M_2, Q) \\ (\sigma_1, \sigma_2, \tau) &\mapsto (\partial\sigma_1 + (p_1)_*\iota_*\tau, \partial\sigma_2 - (p_2)_*\iota_*\tau, -\partial\tau). \end{aligned}$$

It is easy to verify that this map satisfies $\partial^2 = 0$, i.e. we have endowed the birelative chain groups with the structure of a complex. We call its homology groups the *birelative homology groups* and denote them by $H_k(M_1, M_2, Q)$. Explicitly, an element of $H_k(M_1, M_2, Q)$ is represented by a triple $(\sigma_1, \sigma_2, \tau)$ of chains $\sigma_i \in \Delta_k(M_i)$, $i = 1, 2$, and a cycle $\tau \in \Delta_{k-1}(Q)$, such that $\partial\sigma_1 = (p_1)_*\iota_*\tau$ and $\partial\sigma_2 = -(p_2)_*\iota_*\tau$. For each degree k , the birelative chain group fits, by definition, into the short exact sequence

$$0 \longrightarrow \Delta_k(M_1) \oplus \Delta_k(M_2) \xrightarrow{\alpha} \Delta_k(M_1, M_2, Q) \xrightarrow{\beta} \Delta_{k-1}(Q) \longrightarrow 0, \quad (3-4)$$

of complexes in which α is the inclusion and β is the projection.

To explain the term birelative homology we observe that we have generalized relative homology in the following sense: if we take $M_2 = pt$, so that we can identify Q with a submanifold of M_1 , there is a canonical isomorphism $H_k(M_1, pt, Q) \rightarrow H_k(M_1, Q)$, where $H_k(M_1, Q)$, the relative homology group of M_1 with respect to the submanifold Q .

Dual to the singular homology groups there are singular cohomology groups, defined to be the cohomology of a complex whose cochain groups are

$$\Delta^k(M, R) := \text{Hom}(\Delta_k(M), R)$$

for a coefficient ring R , and whose coboundary operator

$$\delta : \Delta^k(M, R) \rightarrow \Delta^{k+1}(M, R)$$

is given by $\delta\varphi(\sigma) := \varphi(\partial\sigma)$ for any $(k+1)$ -simplex σ in M . There is a canonical well-defined pairing

$$H^k(M, R) \times H_k(M) \rightarrow R : ([\varphi], [\sigma]) \mapsto \varphi(\sigma).$$

It is often convenient to recover the cohomology groups with values in the real numbers in a geometric way, for instance through differential forms. Let

us recall how this works: the integrals of k -forms $\varphi \in \Omega^k(M)$ over k -simplices $\sigma \in \Delta_k(M)$ define homomorphisms $\Psi_k : \Omega^k(M) \rightarrow \Delta^k(M, \mathbb{R})$ which, by Stokes's Theorem, fit together to a chain map. The induced homomorphism

$$\Psi^* : H_{\text{dR}}^k(M) \rightarrow H^k(M, \mathbb{R})$$

from de Rham cohomology to singular cohomology is an isomorphism, which is known as the de Rham isomorphism [Bre93].

Analogously as for ordinary singular cohomology, we can also define birelative cohomology. Thus there are birelative cochain groups $\Delta^k(M_1, M_2, Q, R)$, birelative cohomology groups $H^k(M_1, M_2, Q, R)$, and a canonical pairing

$$H^k(M_1, M_2, Q, R) \times H_k(M_1, M_2, Q) \rightarrow R.$$

Note that because the exact sequence (3-4) splits, the dual sequence

$$0 \longrightarrow \Delta^{k-1}(Q, R) \longrightarrow \Delta^k(M_1, M_2, R) \longrightarrow \Delta^k(M_1) \oplus \Delta^k(M_2) \longrightarrow 0$$

is exact, too, and induces a long exact sequence in cohomology:

$$\begin{array}{ccccccc} \dots & \longrightarrow & H^{k-1}(Q, R) & \longrightarrow & H^k(M_1, M_2, Q, R) & & \\ & & & & \searrow & & \\ & & & & & & \\ & & & & & & \\ & & & & \nearrow & & \\ & & & & H^k(M_1, R) \oplus H^k(M_2, R) & \longrightarrow & H^k(Q, R) \longrightarrow \dots \end{array} \quad (3-5)$$

We would like to express the birelative cohomology groups with real coefficients by differential forms in a similar way as the de Rham isomorphism does it for ordinary cohomology. To this end we consider the vector spaces

$$\Omega^k(M_1, M_2, Q) := \Omega^k(M_1) \oplus \Omega^k(M_2) \oplus \Omega^{k-1}(Q)$$

together with the linear maps

$$\begin{aligned} d : \Omega^k(M_1, M_2, Q) &\rightarrow \Omega^{k+1}(M_1, M_2, Q) \\ (H_1, H_2, \varpi) &\mapsto (dH_1, dH_2, \iota^*(p_1^*H_1 - p_2^*H_2) - d\varpi). \end{aligned}$$

This defines a complex:

$$\begin{aligned} d^2(H_1, H_2, \varpi) &= d(dH_1, dH_2, \iota^*(p_1^*H_1 - p_2^*H_2) - d\varpi) \\ &= (d^2H_1, d^2H_2, \iota^*(p_1^*dH_1 - p_2^*dH_2) \\ &\quad - d\iota^*(p_1^*H_1 - p_2^*H_2) + d^2\varpi) \\ &= (0, 0, 0). \end{aligned}$$

We call the cohomology of this complex the *birelative de Rham cohomology* and denote it by $H_{\text{dR}}^k(M_1, M_2, Q)$. By putting $M_2 = pt$, this is nothing but the relative de Rham cohomology of the inclusion $\iota : Q \rightarrow M$ [BT82]. Notice that

a topologically trivial M_1 - M_2 -bi-brane (Q, ϖ) provides us with an element (H_1, H_2, ϖ) of $\Omega^3(M_1, M_2, Q)$. The relation between the 3-forms H_i and the 2-form ϖ from Definition 3.2.2 shows that (H_1, H_2, ϖ) is a cocycle and thus defines a class in the birelative de Rham cohomology.

Similarly to the definition of the homomorphism $\Psi : \Omega^k(M) \rightarrow \Delta^k(M, \mathbb{R})$ mentioned above we obtain a natural homomorphism

$$\Psi_{\text{bi}} : \Omega^k(M_1, M_2, Q) \rightarrow \Delta^k(M_1, M_2, Q, \mathbb{R})$$

which by definition associates to a triple $(H_1, H_2, \varpi) \in \Omega^k(M_1, M_2, Q)$ evaluated on an element $(\sigma_1, \sigma_2, \tau) \in \Delta_k(M_1, M_2, Q)$ the real number

$$\Psi_{\text{bi}}(H_1, H_2, \varpi)(\sigma_1, \sigma_2, \tau) := \int_{\sigma_1} H_1 + \int_{\sigma_2} H_2 + \int_{\tau} \varpi. \quad (3-6)$$

Lemma 3.2.3. *The homomorphisms Ψ_{bi} fit together to a chain map, and the induced homomorphism*

$$\Psi_{\text{bi}}^* : H_{\text{dR}}^k(M_1, M_2, Q) \rightarrow H^k(M_1, M_2, Q, \mathbb{R})$$

is an isomorphism.

Proof. We show that Ψ_{bi} is a chain map:

$$\begin{aligned} & (\delta \Psi_{\text{bi}}(H_1, H_2, \varpi))(\sigma_1, \sigma_2, \tau) \\ &= \Psi_{\text{bi}}(H_1, H_2, \varpi)(\partial \sigma_1 + (p_1)_* \iota_* \tau, \partial \sigma_2 - (p_2)_* \iota_* \tau, -\partial \tau) \\ &= \int_{\partial \sigma_1 + (p_1)_* \iota_* \tau} H_1 + \int_{\partial \sigma_2 - (p_2)_* \iota_* \tau} H_2 + \int_{-\partial \tau} \varpi \\ &= \int_{\sigma_1} dH_1 + \int_{\sigma_2} dH_2 + \int_{\tau} \iota^*(p_1^* H_1 - p_2^* H_2) - d\varpi \\ &= \Psi_{\text{bi}}(dH_1, dH_2, \iota^*(p_1^* H_1 - p_2^* H_2) - d\varpi)(\sigma_1, \sigma_2, \tau) \\ &= \Psi_{\text{bi}}(d(H_1, H_2, \varpi))(\sigma_1, \sigma_2, \tau). \end{aligned}$$

To prove the second claim, note that by definition we have an exact sequence

$$0 \longrightarrow \Omega^{k-1}(Q) \xrightarrow{\alpha} \Omega^k(M_1, M_2, Q) \xrightarrow{\beta} \Omega^k(M_1) \oplus \Omega^k(M_2) \longrightarrow 0,$$

where $\alpha(\varpi) := (0, 0, \varpi)$ and $\beta(H_1, H_2, \varpi) := (H_1, H_2)$. It induces a long exact sequence

$$\begin{aligned} \dots \longrightarrow H_{\text{dR}}^{k-1}(Q) \xrightarrow{\alpha^*} H_{\text{dR}}^k(M_1, M_2, Q) \xrightarrow{\beta^*} H_{\text{dR}}^k(M_1) \oplus H_{\text{dR}}^k(M_2) \longrightarrow \dots \\ \downarrow \quad \uparrow \quad \uparrow \quad \downarrow \\ \dots \longrightarrow H_{\text{dR}}^k(Q) \longrightarrow \dots \end{aligned}$$

in (birelative) de Rham cohomology. Together with the long exact sequence (3–5) in birelative cohomology with values in \mathbb{R} , we have the following diagram with exact columns:

$$\begin{array}{ccc}
H_{\text{dR}}^{k-1}(M_1) \oplus H_{\text{dR}}^{k-1}(M_2) & \xrightarrow{\Psi^* \oplus \Psi^*} & H^{k-1}(M_1, \mathbb{R}) \oplus H^{k-1}(M_2, \mathbb{R}) \\
\downarrow & & \downarrow \\
H_{\text{dR}}^{k-1}(Q) & \xrightarrow{\psi^*} & H^{k-1}(Q, \mathbb{R}) \\
\downarrow & & \downarrow \\
H_{\text{dR}}^k(M_1, M_2, Q) & \xrightarrow{\Psi_{\text{bi}}^*} & H^k(M_1, M_2, Q, \mathbb{R}) \\
\downarrow & & \downarrow \\
H_{\text{dR}}^k(M_1) \oplus H_{\text{dR}}^k(M_2) & \xrightarrow{\Psi^* \oplus \Psi^*} & H^k(M_1, \mathbb{R}) \oplus H^k(M_2, \mathbb{R}) \\
\downarrow & & \downarrow \\
H_{\text{dR}}^k(Q) & \xrightarrow{\psi^*} & H^k(Q, \mathbb{R})
\end{array}$$

It is easy to check that all subdiagrams commute, so that the 5-lemma [Bre93] implies that Ψ_{bi}^* is an isomorphism. \blacksquare

In the same way as for ordinary cohomology, we say that a cocycle in $\Omega^k(M_1, M_2, Q)$ has integral class if its class – identified by Ψ_{bi}^* with a class in $H^k(M_1, M_2, Q, \mathbb{R})$ – lies in the image of the induced homomorphism

$$H^k(M_1, M_2, Q, \mathbb{Z}) \rightarrow H^k(M_1, M_2, Q, \mathbb{R}).$$

In this case the canonical pairing (3–6) of $\Psi_{\text{bi}}^*([H_1, H_2, \varpi])$ with any birelative homology class $[(\sigma_1, \sigma_2, \tau)]$, given by

$$\int_{\sigma_1} H_1 + \int_{\sigma_2} H_2 + \int_{\tau} \varpi,$$

is an integer.

Proposition 3.2.4. *The Wess-Zumino term (3–3) of a topologically trivial M_1 - M_2 -bi-brane (Q, ϖ) ,*

$$S_{H_1, H_2, \varpi}^{\text{WZ}}(\Phi_1, \Phi_2, \Phi_S) := \int_{B_1} \Phi_1^* H_1 + \int_{B_2} \Phi_2^* H_2 + \int_D \Phi_S^* \varpi,$$

is well-defined up to integers, provided that the cocycle (H_1, H_2, ϖ) has integral class.

Proof. To prove this claim, recall that the definition of $S_{H_1, H_2, \varpi}^{\text{WZ}}(\Phi_1, \Phi_2, \Phi_S)$ involves choices of a disc D and of three-dimensional manifolds B_i . Let us

assume for simplicity that the maps $\Phi_i : B_i \rightarrow M_i$ and $\Phi_S : D \rightarrow Q$ are embeddings, so that we can consider with the images as submanifolds D of Q and B_i of M_i . In the general case, one can work with pullbacks on the abstract manifolds. If we represent the submanifolds as singular chains, then

$$\partial D = \phi_S(S), \quad \partial B_1 = \phi_1(\Sigma_1) - (p_1)_*D \quad \text{and} \quad \partial B_2 = \phi_2(\Sigma_2) + (p_2)_*D.$$

Consider now different choices D' , B'_1 and B'_2 , and let $\tau := D - D'$ be a chain in $\Delta_2(Q)$ and $\sigma_i := B_i - B'_i$ be chains in $\Delta_3(M_i)$. We find

$$\partial\tau = 0, \quad \partial\sigma_1 = -(p_1)_*\tau \quad \text{and} \quad \partial\sigma_2 = (p_2)_*\tau,$$

so that $(\sigma_1, \sigma_2, \tau)$ defines a class in the birelative homology $H_3(M_1, M_2, Q)$. The ambiguities of the Wess-Zumino term are thus of the form

$$\begin{aligned} & \left(\int_{B_1} H_1 + \int_{B_2} H_2 + \int_D \varpi \right) - \left(\int_{B'_1} H_1 + \int_{B'_2} H_2 + \int_{D'} \varpi \right) \\ &= \int_{\sigma_1} H_1 + \int_{\sigma_2} H_2 + \int_{\tau} \varpi. \end{aligned}$$

In view of (3–6) these ambiguities are nothing but the pairing of the birelative cycle $(\sigma_1, \sigma_2, \tau)$ with (H_1, H_2, ϖ) . If (H_1, H_2, ϖ) is integral, this gives an integer. \blacksquare

Summarizing, from the discussion of a defect line separating two topologically trivial sigma models we have seen that a 2-form ϖ on a submanifold in the product of the two target spaces is appropriate to define the Wess-Zumino term, and thus holonomy for surfaces with boundary. In the next section we consider general sigma models.

3.3 Bi-Branes II: Gerbe Bimodules

Just as in the previous section, we consider a worldsheet Σ with a defect line S separating sigma models which now may be topologically non-trivial. In order to generalize Definition 3.2.2 to topologically non-trivial bi-branes, we invent the following new structure.

Definition 3.3.1. *Let \mathcal{G} and \mathcal{H} be bundle gerbes over M . A \mathcal{G} - \mathcal{H} -bimodule is a 1-morphism*

$$\mathcal{D} : \mathcal{G} \rightarrow \mathcal{H} \otimes \mathcal{I}_\varpi.$$

Bundle gerbe bimodules behave similar to bundle gerbe modules. Again, its definition as 1-morphisms makes it clear that \mathcal{G} - \mathcal{H} -bimodules form a category $\mathcal{G}\text{-}\mathcal{H}\text{-}\mathfrak{Bimod}$. Any pair of 1-isomorphisms $\mathcal{A} : \mathcal{G} \rightarrow \mathcal{G}'$ and $\mathcal{B} : \mathcal{H} \rightarrow \mathcal{H}'$ defines an equivalence of categories

$$\mathcal{G}\text{-}\mathcal{H}\text{-Bimod} \cong \mathcal{G}'\text{-}\mathcal{H}'\text{-Bimod}. \quad (3-7)$$

Using the duality on the 2-category of bundle gerbes introduced in §2.5, one can deduce equivalences of categories

$$\mathcal{G}\text{-}\mathcal{H}\text{-Bimod} \cong \mathcal{LMod}(\mathcal{H}^* \otimes \mathcal{G}) \cong \mathcal{RMod}(\mathcal{G}^* \otimes \mathcal{H}). \quad (3-8)$$

There are some more analogies with bimodules over algebras. For example, if \mathcal{D} is a $\mathcal{G}\text{-}\mathcal{H}$ -bimodule, and \mathcal{E} is a left \mathcal{H} -module, we can form the *tensor product over \mathcal{H}* , which is here just the composition

$$\mathcal{G} \xrightarrow{\mathcal{D}} \mathcal{H} \otimes \mathcal{I}_\varpi \xrightarrow{\mathcal{E} \otimes \text{id}} \mathcal{I}_\rho \otimes \mathcal{I}_\varpi = \mathcal{I}_{\rho+\varpi}.$$

This gives obviously a left \mathcal{G} -module, which we denote by $\mathcal{D} \otimes_{\mathcal{H}} \mathcal{E}$. Similarly, a $\mathcal{G}\text{-}\mathcal{H}$ -bimodule \mathcal{D} and a right \mathcal{G} -module \mathcal{E} give a right \mathcal{H} -module $\mathcal{E} \otimes_{\mathcal{G}} \mathcal{D}$. On the other hand, a $\mathcal{G}\text{-}\mathcal{H}$ -bimodule can in general neither be considered as a left \mathcal{G} -module nor as a right \mathcal{H} -module. Let us finally discuss a $\mathcal{I}_{\rho_1}\text{-}\mathcal{I}_{\rho_2}$ -bimodule for trivial bundle gerbes \mathcal{I}_{ρ_1} and \mathcal{I}_{ρ_2} . The equivalence Bun from Proposition 2.4.5 becomes now a functor

$$\text{Bun} : \mathcal{I}_{\rho_1}\text{-}\mathcal{I}_{\rho_2}\text{-Bimod} \rightarrow \mathfrak{Bun}(M)$$

whereby such a bimodule is nothing but a vector bundle over M . Moreover, if \mathcal{D} is a $\mathcal{G}_1\text{-}\mathcal{G}_2$ -bimodule, any pair of trivializations $\mathcal{T}_1 : \mathcal{G}_1 \rightarrow \mathcal{I}_{\rho_1}$ and $\mathcal{T}_2 : \mathcal{G}_2 \rightarrow \mathcal{I}_{\rho_2}$ induces by (3-7) a functor

$$\mathcal{G}_1\text{-}\mathcal{G}_2\text{-Bimod} \rightarrow \mathfrak{Bun}(M). \quad (3-9)$$

To consider a bundle gerbe bimodule \mathcal{D} in terms of local expressions, let \mathfrak{V} be an open cover of M , (g, A, B) be a cocycle for \mathcal{G} , and (g', A', B') a cocycle for \mathcal{H} . Then, the bimodule has local data (H_{ij}, Q_i) consisting of smooth functions $H_{ij} : V_i \cap V_j \rightarrow \text{U}(n)$ and $\mathfrak{u}(n)$ -valued 1-forms Q_i on V_i , similar to a bundle gerbe module, but now satisfying

$$\begin{aligned} g'_{ijk} &= g_{ijk} \cdot H_{ik} \cdot H_{jk}^{-1} \cdot H_{ij}^{-1} \\ A'_{ij} &= A_{ij} + Q_j - H_{ij}^{-1} Q_i H_{ij} - iH_{ij}^{-1} dH_{ij} \\ B'_i + \varpi &= B_i + dQ_i. \end{aligned}$$

Now we are ready to generalize Definition 3.2.2 of a topologically trivial bi-brane to a general bi-brane.

Definition 3.3.2. *Let \mathcal{G}_1 be a bundle gerbe over M_1 , and \mathcal{G}_2 be a bundle gerbe over M_2 . A $\mathcal{G}_1\text{-}\mathcal{G}_2$ -bi-brane is a submanifold $Q \subset M_1 \times M_2$ together with a $(p_1^* \mathcal{G}_1)|_Q\text{-}(p_2^* \mathcal{G}_2)|_Q$ -bimodule: a 1-morphism*

$$\mathcal{D} : (p_1^* \mathcal{G}_1)|_Q \rightarrow (p_2^* \mathcal{G}_2)|_Q \otimes \mathcal{I}_\varpi.$$

The two-form ϖ is called the curvature, and the submanifold Q is called the world volume of the bi-brane.

Notice that the curvatures $H_i := \text{curv}(\mathcal{G}_i)$ and the 2-form ϖ of a \mathcal{G}_1 - \mathcal{G}_2 -bi-brane are related in the same way as for a topologically trivial bi-brane. With the present definition of a bi-brane, the equivalences (3–8) between bundle gerbe bimodules and bundle gerbe modules suggests a certain relation between bi-branes and D-branes, which are, from the point of view of conformal field theory, related to the so-called folding trick [WA94, FSW].

We recall that we defined the Wess-Zumino term in the previous section for the following situation: a closed oriented worldsheet Σ with defect line S , which separates Σ into two components Σ_1 and Σ_2 , together with maps $\phi_i : \Sigma_i \rightarrow M_i$ for $i = 1, 2$ such that the image of the combined map

$$\phi_S : S \rightarrow M_1 \times M_2 : s \mapsto (\phi_1(s), \phi_2(s))$$

is contained in Q . The orientation of Σ_i is the one inherited from the orientation of Σ , and without loss of generality we assume $\partial\Sigma_1 = S$ and $\partial\Sigma_2 = \bar{S}$, see Figure 3.3 on page 75.

Definition 3.3.3. *Let \mathcal{G}_i be a bundle gerbe over M_i for $i = 1, 2$, and let (Q, \mathcal{D}) be a \mathcal{G}_1 - \mathcal{G}_2 -bi-brane. Let Σ be an oriented closed surface with defect line S , and let $\phi_i : \Sigma_i \rightarrow M_i$ be smooth maps such that $\phi_S(S) \subset Q$. Let*

$$\mathcal{T}_1 : \phi_1^* \mathcal{G}_1 \rightarrow \mathcal{I}_{\rho_1} \quad \text{and} \quad \mathcal{T}_2 : \phi_2^* \mathcal{G}_2 \rightarrow \mathcal{I}_{\rho_2}$$

be trivializations of the pullback bundle gerbes over Σ_i , and let

$$F := \text{Bun}((\mathcal{T}_2 \otimes \text{id})|_S \circ \phi_S^* \mathcal{D} \circ \mathcal{T}_1^{-1}|_S)$$

be the vector bundle over S associated by (3–9). The oriented bi-brane holonomy is the complex number

$$\text{Hol}_{\mathcal{G}_1, \mathcal{G}_2, \mathcal{D}}(\phi_1, \phi_2, \Sigma) := \exp 2\pi i \left(\int_{\Sigma_1} \rho_1 + \int_{\Sigma_2} \rho_2 \right) \cdot \text{tr}(\text{Hol}_F(S)) \in \mathbb{C}.$$

This definition does not depend on the choice of the trivializations \mathcal{T}_1 and \mathcal{T}_2 , as we shall now establish. If \mathcal{T}'_1 and \mathcal{T}'_2 are two different choices of trivializations, and F' is the corresponding vector bundle over S , we obtain the line bundles

$$T_i := \text{Bun}(\mathcal{T}'_i \circ \mathcal{T}_i^{-1})$$

over Σ_i of curvature $\text{curv}(T_i) = \rho'_i - \rho_i$ by Corollary 2.4.6. Then we have

$$(\mathcal{T}_2 \otimes \text{id}) \circ \phi_S^* \mathcal{D} \circ \mathcal{T}_2^{-1} \cong (\mathcal{T}_2 \circ (\mathcal{T}'_2)^{-1} \otimes \text{id}) \circ (\mathcal{T}'_2 \otimes \text{id}) \circ \mathcal{D} \circ (\mathcal{T}'_1)^{-1} \circ \mathcal{T}'_1 \circ \mathcal{T}_1^{-1}.$$

Now the compatibility of the functor Bun with the composition of 1-morphisms by Proposition 2.4.5 (i) gives us an isomorphism

$$F \cong T_2^* \otimes F' \otimes T_1$$

of vector bundles over S . By construction we have $\partial\Sigma_1 = S$ and $\partial\Sigma_2 = \bar{S}$, and since the curvature of the bundles T_i is $\text{curv}(T_i) = \rho'_i - \rho_i$, the holonomies of T_1 and T_2 around S are given by

$$\text{Hol}_{T_1}(S) = \exp\left(2\pi i \int_{\Sigma_1} \rho'_1 - \rho_1\right) \text{ and } (\text{Hol}_{T_2}(S))^{-1} = \exp\left(2\pi i \int_{\Sigma_2} \rho'_2 - \rho_2\right)$$

respectively. From the isomorphism of vector bundles above we get

$$\text{tr}(\text{Hol}_E(S)) = \text{tr}(\text{Hol}_{T_2^* \otimes F' \otimes T_1}(\cdot)(S)) = (\text{Hol}_{T_2}(S))^{-1} \cdot \text{tr}(\text{Hol}_{F'}(S)) \cdot \text{Hol}_{T_1}(S).$$

Together with the above expressions for the holonomies of T_1 and T_2 this shows the independence of the holonomy of the choice of the trivializations.

We show in Figure 3.7 on page 89 how oriented bi-brane holonomy can be computed from local expressions for the bundle gerbes and the bi-modules.

Proposition 3.3.4. *Let \mathcal{G}_i be bundle gerbes over smooth manifolds M_i , respectively, and let (Q, \mathcal{D}) be a \mathcal{G}_1 - \mathcal{G}_2 -bi-brane of curvature ϖ . Oriented bi-brane holonomy has the following properties:*

(i) *If there is a 2-isomorphism $\mathcal{D} \Rightarrow \mathcal{D}'$,*

$$\text{Hol}_{\mathcal{G}_1, \mathcal{G}_2, \mathcal{D}}(\phi_1, \phi_2, \Sigma) = \text{Hol}_{\mathcal{G}_1, \mathcal{G}_2, \mathcal{D}'}(\phi_1, \phi_2).$$

(ii) *If $\mathcal{A}_i : \mathcal{G}'_i \rightarrow \mathcal{G}_i$ are 1-isomorphisms for $i = 1, 2$, and $\mathcal{D}' := (\mathcal{A}_2^{-1} \otimes \text{id}) \circ \mathcal{D} \circ \mathcal{A}_1$ is the corresponding bimodule under the equivalence (3-7)*

$$\text{Hol}_{\mathcal{G}_1, \mathcal{G}_2, \mathcal{D}}(\phi_1, \phi_2, \Sigma) = \text{Hol}_{\mathcal{G}'_1, \mathcal{G}'_2, \mathcal{D}'}(\phi_1, \phi_2, \Sigma).$$

(iii) *If B is a three-dimensional manifold separated in two parts $B = B_1 \cup_D B_2$ along a disc D , and $\Phi_i : B_i \rightarrow M_i$ are smooth maps such that the image of the combined map*

$$\Phi_S : D \rightarrow M_1 \times M_2 : x \mapsto (\Phi_1(x), \Phi_2(x))$$

is contained in the submanifold Q ,

$$\begin{aligned} & \text{Hol}_{\mathcal{G}_1, \mathcal{G}_2, \mathcal{D}}(\Phi|_{\Sigma_1}, \Phi|_{\Sigma_2}, \partial B) \\ &= \exp 2\pi i \left(\int_{B_1} \Phi_1^* H_1 + \int_{B_2} \Phi_2^* H_2 + \int_D \Phi_S^* \varpi \right), \end{aligned}$$

where $\Sigma_i := \partial B_i \setminus D$ and $H_i := \text{curv}(\mathcal{G}_i)$.

Proof. The only non-trivial part is (iii), and it can be proven similarly to Proposition 3.1.4. So, let $\mathcal{T}_i : \Phi^* \mathcal{G}_i|_{\partial B_i} \rightarrow \mathcal{I}_{\rho_i}$ be trivializations of the two bundle gerbes over ∂B_i , thus producing a vector bundle F over D of curvature

$$\frac{1}{n} \text{tr}(\text{curv}(F)) = \Phi_S^* \varpi + \rho_2|_D - \rho_1|_D. \quad (3-10)$$

The left hand side of the claimed equation is

$$\text{Hol}_{\mathcal{G}_1, \mathcal{G}_2, \mathcal{D}}(\Phi|_{\Sigma_1}, \Phi|_{\Sigma_2}, \partial B) = \exp 2\pi i \left(\int_{\Sigma_1} \rho_1 + \int_{\Sigma_2} \rho_2 \right) \cdot \text{tr}(\text{Hol}_F(S)).$$

Here the holonomy of the vector bundle F around $S := \partial\Sigma_1 = \partial D$ becomes by (3–10)

$$\text{tr}(\text{Hol}_F(S)) = \text{tr}(\text{Hol}_F(\partial D)) = \exp \left(2\pi i \int_D \Phi_S^* \varpi + \rho_2 - \rho_1 \right). \quad (3-11)$$

The holonomy of the bundle gerbe $\mathcal{G}_i|_{\partial B_i}$ around the closed surface ∂B_i is, by definition,

$$\text{Hol}_{\mathcal{G}_i}(\Phi_i, \partial B_i) = \exp \left(2\pi i \int_{\partial B_i} \rho_i \right) = \exp \left(2\pi i \int_{\Sigma_i} \rho_i \pm 2\pi i \int_D \rho_i \right)$$

with a minus sign for $i = 1$ and a plus sign for $i = 2$, according to the relative orientations of D and ∂B_i . On the other hand, we have by Theorem 1.5.4

$$\text{Hol}_{\mathcal{G}_i}(\Phi_i, \partial B_i) = \exp \left(2\pi i \int_{B_i} H_i \right).$$

The last four equalities prove the claim. ■

In particular, since we can apply Proposition 3.3.4 to any cycle in the birelative homology, we reproduce the integrality condition from Proposition 3.2.4,

Corollary 3.3.5. *Let \mathcal{G}_i be a bundle gerbe over M_i of curvature H_i , for $i = 1, 2$, and let (Q, \mathcal{D}) be a \mathcal{G}_1 - \mathcal{G}_2 -bi-brane of curvature ϖ . Then, the triple (H_1, H_2, ϖ) is a cocycle in the birelative de Rham cohomology with integral class.*

Summarizing, we have – inspired by sigma models – extended the notion of surface holonomy for oriented closed surfaces from §1.5 and for oriented surface with boundary from §3.1 to oriented surface with defect lines.

3.4 Application: Worldsheets with Boundaries and Defects

In this section we discuss sigma models for worldsheets with boundaries and defect lines, and define Wess-Zumino terms using oriented bi-brane and D-brane holonomy. Let us start with the situation where there are no defect lines but boundaries. Compared to Definition 3.1.3, we admit several D-branes, and different boundary components may be mapped into the world volumes of different D-branes.

Definition 3.4.1. A *sigma model for oriented worldsheets with boundary* is a smooth Riemannian manifold (M, g) , a bundle gerbe \mathcal{G} over M and a family $\mathfrak{E} = \{(Q_i, \mathcal{E}_i)\}_{i \in I}$ of \mathcal{G} -D-branes. Let Σ be an oriented conformal surface with boundary components $\{C_b\}_{b \in B}$, and let $\phi : \Sigma \rightarrow M$ be a smooth map together with a map $i : B \rightarrow I$ that assigns to each boundary component b a D-brane $i(b)$ in such a way that $\phi(C_b) \subset Q_{i(b)}$. The *Feynman amplitude* of $\phi : \Sigma \rightarrow M$ is the complex number

$$\mathcal{A}_{g, \mathcal{G}, \mathfrak{E}}(\phi, \Sigma) := S_g^{\text{kin}}(\phi) \cdot \exp\left(2\pi i \int_{\Sigma} \rho\right) \cdot \prod_{b \in B} \text{tr}(\text{Hol}_{E_b}(C_b)) \in \mathbb{C},$$

where the 2-form $\rho \in \Omega^2(\Sigma)$ comes from a trivialization $\mathcal{T} : \phi^*\mathcal{G} \rightarrow \mathcal{I}_\rho$, and the vector bundles E_b over C_b are defined by $E_b := \text{Bun}(\phi^*\mathcal{E}_{i(b)} \circ \mathcal{T}^{-1}|_{C_b})$.

From the discussion of the oriented D-brane holonomy in Definition 3.1.3 it follows directly that the amplitude $\mathcal{A}_{g, \mathcal{G}, \mathfrak{E}}(\phi, \Sigma)$ does not depend on the choice of the trivialization.

Let us at this place explain why we still speak about holonomy and not about parallel transport, even when the surface has boundaries. To see this it is useful to consider a string moving through a target space M , parameterized by a worldsheet which is a cylinder $\Sigma = S^1 \times [0, 1]$. The situation of Definitions 3.1.3 and 3.4.1 refers to an open string, which moves along a closed line, so that the cylinder is swept out like in Figure 3.4. Since we have a *closed* path, we

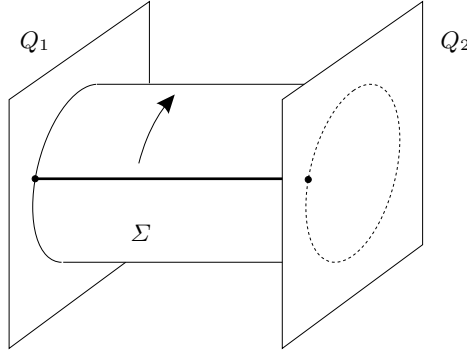

Figure 3.4: An open string moves on a closed path, its endpoints restricted to two D-branes with world volumes Q_1 and Q_2 . It sweeps out a surface Σ with boundary.

speak about holonomy. In contrast, the same surface Σ can have a completely different meaning, namely that of a closed string moving along an *open* path

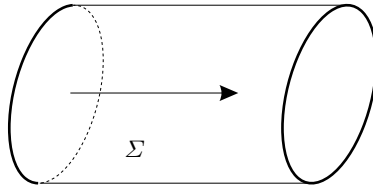

Figure 3.5: A closed string moves along an open path.

like in Figure 3.5. Situations with such field insertions at the endpoints of open paths are not covered by Definition 3.4.1.

To deal with them, one has two alternatives: the first is to consider the cylinder in M as a path in the loop space LM . Parallel transport along such paths is provided by line bundles with connection on LM . Indeed, any gerbe over M with connection defines a line bundle with connection over LM by so-called transgression. This was discovered first on the level of Deligne cohomology [Gaw88, Bry93, GT01], but has also found geometric interpretation for Dixmier-Douady sheaves of groupoids with connection [Bry93], and for bundle gerbes [GR02, Wal06]. The second alternative is to consider the cylinder as a 2-morphism in the path 2-groupoid of the manifold M . Then one can use the theory of transport 2-functors, and perform an actual parallel transport along this 2-morphism [SWa, SWb].

Now we incorporate defect lines into the above definition of a sigma model for worldsheets with boundaries. In general, we say that an *oriented worldsheet with boundary and defects* is an oriented conformal surface Σ with boundary components $\{C_b\}_{b \in B}$ and (non-intersecting) defect lines $\{S_d\}_{d \in D}$, see Figure 3.6. The connected components of $\Sigma \setminus \{S_d\}_{d \in D}$ are denoted by Σ_k , labelled by

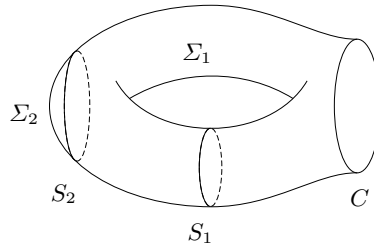

Figure 3.6: A worldsheet with boundary C is separated by two defect lines S_1 and S_2 in two components Σ_1 and Σ_2 .

an index set K . Note that every component Σ_k inherits a conformal structure and an orientation from Σ . We denote by $k(b)$ the label of the component $\Sigma_{k(b)}$ to which the boundary C_b belongs, and similarly by $k_1(d)$ and $k_2(d)$ the labels of the components on the two sides of the defect line S_d . We make the convention that the orientation induced on a defect line S_d from the component $\Sigma_{k_1(d)}$ coincides with the orientation on S_d , while then the orientation induced from $\Sigma_{k_2(d)}$ is then necessarily opposite.

Definition 3.4.2.

- (i) *A sigma model for oriented worldsheets with boundary and defects is a family $\mathfrak{M} = \{(M_k, g_k, \mathcal{G}_k, \mathfrak{E}_k)\}_{k \in K}$ of sigma models for oriented worldsheets with boundary, each equipped with a family of D-branes collected in $\mathfrak{E}_k = \{(Q_{k,i}, \mathcal{E}_{k,i})\}_{i \in I_k}$, together with a family $\mathfrak{D} = \{(k_j^1, k_j^2, Q_j, \mathcal{D}_j)\}_{j \in J}$, where $k_j^1, k_j^2 \in K$ and (Q_j, \mathcal{D}_j) is a $\mathcal{G}_{k_j^1}$ - $\mathcal{G}_{k_j^2}$ -bi-brane.*
- (ii) *Let Σ be a worldsheet with boundary and defects with components Σ_k labelled by the same index set as the sigma models in (i), and let $i : B \rightarrow I_{k(b)}$ and $j : D \rightarrow J$ be maps assigning to each boundary component a D-brane and to each defect line a bi-brane. Let $\{\phi_k\}_{k \in K}$ be a family of smooth maps $\phi_k : \Sigma_k \rightarrow M_k$ with*

$$\phi_{k(b)}(C_b) \subset Q_{k(b), i(b)} \quad \text{and} \quad \phi_{S_d}(S_d) \subset Q_{j(d)},$$

where $\phi_{S_d} : S_d \rightarrow M_{k_1(d)} \times M_{k_2(d)}$ is the map combined from the restrictions of $\phi_{k_1(d)}$ and $\phi_{k_2(d)}$ to S_d . The Feynman amplitude of the family $\{\phi_k\}$ is the complex number

$$\begin{aligned} \mathcal{A}_{\mathfrak{M}, \mathfrak{D}}(\{\phi_k\}, \Sigma) := & \prod_{k \in K} S_{g_k}^{\text{kin}}(\phi_k) \cdot \exp\left(2\pi i \int_{\Sigma_k} \rho_k\right) \\ & \cdot \prod_{b \in B} \text{tr}(\text{Hol}_{E_b}(C_b)) \cdot \prod_{d \in D} \text{tr}(\text{Hol}_{F_d}(S_d)) \in \mathbb{C}, \end{aligned}$$

where the 2-forms $\rho_k \in \Omega^2(\Sigma_k)$ come from trivialization $\mathcal{T}_k : \phi_k^* \mathcal{G}_k \rightarrow \mathcal{I}_{\rho_k}$, and the vector bundles E_b over C_b and F_d over S_d are defined by

$$E_b := \text{Bun}(\phi_k^* \mathcal{E}_{k(b), i(b)} \circ \mathcal{T}_k^{-1}|_{C_b})$$

and

$$F_d := \text{Bun}((\mathcal{T}_{k_2(d)} \otimes \text{id})|_{S_d} \circ \phi_{S_d}^* \mathcal{D}_d \circ \mathcal{T}_{k_1(d)}^{-1}|_{S_d}).$$

This Feynman amplitude is again independent of the choices of the trivializations. Notice that we have not imposed any constraints on the topology of the target spaces or the branes. Finally, we show in Figure 3.7 how the holonomy of a surface with boundary and defects can be obtained from local data.

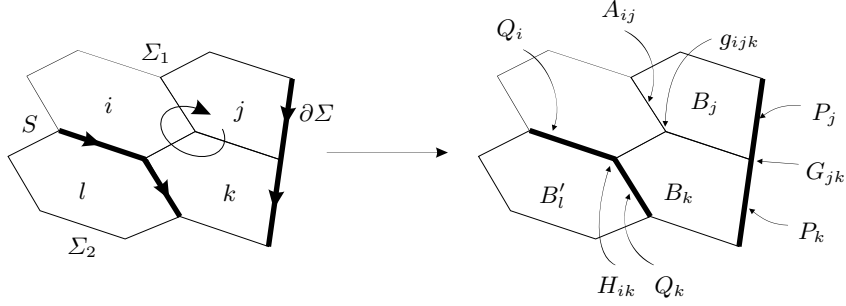

Figure 3.7: A piece of a surface with boundary and a defect line, and with an adapted triangulation, becomes decorated with local data of two bundle gerbes, a bundle gerbe module and a bundle gerbe bimodule.

3.5 Symmetric Branes in Wess-Zumino-Witten Models

As we have explained in §1.6, a Wess-Zumino-Witten model is a sigma model whose target space is a Lie group, whose metric is Ad-invariant, and whose bundle gerbe has a certain curvature. Wess-Zumino-Witten models give rise to important examples of two-dimensional conformal field theories.

In this section we describe, which of the D-branes and bi-branes can be used as branes for Wess-Zumino-Witten models. We call them *symmetric D-branes* and *symmetric bi-branes* respectively. In the associated conformal field theory, symmetric D-branes give rise to conformal boundary conditions, while symmetric bi-branes give rise to topological defect lines. The definition of symmetric branes divides in two parts. The first part is to decide which world volumes one has to consider. One rationale here is to study the scattering of bulk fields. This is based on the general idea (see e.g. [FG94]) that (a subspace of) the space of bulk fields can be identified with a truncation and deformation of the algebra of functions on the target space. The second part is to find conditions on the bundle gerbe modules and bimodules that live on these world volumes. In the case of D-branes the study of the scattering of bulk fields amounts, in tree level approximation to string theory scattering amplitudes, to computing the two-point functions of bulk fields on a disc with given boundary condition. By factorization to a three-point function on the sphere and a one-point function on the disc, this can be reduced [VFPS97, FFFS00] to the computation of one-point functions of bulk fields on the disc. The result of this computation is, that the world volumes of symmetric D-branes are conjugacy classes in the target space Lie group G [FFFS00].

The conditions on the bundle gerbe module of a symmetric D-brane have been deduced in [Gaw05]. Summarizing, we have

Definition 3.5.1. Let $(G, \langle -, - \rangle, \mathcal{G})$ be a Wess-Zumino-Witten model. A \mathcal{G} -D-brane (Q, \mathcal{E}) is called symmetric, if the following three conditions are satisfied:

1. its world volume Q is a conjugacy class \mathcal{C}_h of G ;
2. the curvature $\text{curv}(E)$ of the vector bundle E of the \mathcal{G} -module \mathcal{E} takes its values only in the center of the Lie algebra $\mathfrak{u}(n)$ and can thus be identified with a real 2-form;
3. the curvature ω is fixed to multiple of the 2-form

$$\omega_h = \left\langle \theta|_{\mathcal{C}_h} \wedge \frac{\text{Ad}^{-1} + \text{id}_{\mathfrak{g}}}{\text{Ad}^{-1} - \text{id}_{\mathfrak{g}}} \theta|_{\mathcal{C}_h} \right\rangle,$$

which has already appeared in the construction of canonical bundle gerbes over Lie groups in §1.4.

Conditions 2 and 3 restrict the choice of the conjugacy class to conjugacy classes that correspond to integrable highest weights [Gaw05]. This amounts in particular to have a finite number of non-intersecting D-brane world volumes. Recall that the curvature $H := \text{curv}(\mathcal{G})$ is fixed to a multiple $k\eta$ of the 3-form η on G , and that $\eta|_{\mathcal{C}_h} = d\omega_h$. Among all 2-forms with the latter property, ω_h is distinguished by the fact that it is invariant under the conjugation action of G on \mathcal{C}_h . This invariance is essential for boundary conditions for the corresponding conformal field theory.

In order to find the world volumes for symmetric bi-branes we use again the scattering of bulk fields [FSW]. In the tree-level approximation we consider the two-point function of bulk fields on a world sheet that is a sphere S^2 containing a closed defect line, which is the equator of the sphere. If both bulk field insertions are on the same hemisphere, then by factorization we just obtain the correlator in the absence of a defect, multiplied by the quantum dimension of the defect [FFRS06]. To get information on the relevant geometry of the target space, we must thus consider the situation with the two bulk insertions on different hemispheres, i.e. on different sides of the defect line.

In the calculation performed in [FSW], we take both target spaces to be the same Lie group G , and thus expect to find subsets of the product $G \times G$. Interestingly, 2-characters of the group G pop up, functions on $G \times G$ given by

$$\chi^{(2)} : G \times G \rightarrow \mathbb{C} : (g_1, g_2) \mapsto \text{tr}(g_1 g_2^{-1})$$

in some representation. They first appeared in [Fro96] in the expansion of group determinants. Compared to characters, they contain more information about the group; e.g. they allow one to determine whether a representation is real or pseudo-real. Still, 2-characters and characters do not determine a group up to isomorphism. A surprisingly recent result [Hor99] states that a finite group is determined by its 1-, 2- and 3-characters.

The result of the calculation from [FSW] is, that the geometric object in $G \times G$ that is relevant for symmetric bi-branes is the set of those points (g_1, g_2)

of $G \times G$ on which the 2-character of a certain representation is constant: these subsets of $G \times G$ are the following submanifolds:

Definition 3.5.2. *For a compact connected Lie group G and elements $h_1, h_2 \in G$ we call the submanifold*

$$\mathcal{B}_{h_1, h_2} := \{(g_1, g_2) \in G \times G \mid \exists x_1, x_2 \in G \text{ with } g_1 = x_1 h_1 x_2^{-1}, g_2 = x_1 h_2 x_2^{-1}\}$$

in $G \times G$ the biconjugacy class of the pair (h_1, h_2) .

Biconjugacy classes inherit from the diagonal left and diagonal right actions of G on $G \times G$ two commuting actions of G . Obviously, 2-characters are constant on biconjugacy classes. In fact, very much like the characters of irreducible G -representations form a natural basis for the functions on the space of conjugacy classes, the 2-characters of irreducible representations form a basis for the space of functions on biconjugacy classes. This leads us to the conclusion that the world volumes of symmetric bi-branes are biconjugacy classes. Next we observe that the smooth map

$$\tilde{\mu} : G \times G \rightarrow G : (g_1, g_2) \mapsto g_1 g_2^{-1} \quad (3-12)$$

intertwines the diagonal left and diagonal right action of G on $G \times G$ and the adjoint and trivial actions of G on itself, respectively. Put differently, $\tilde{\mu}$ defines the structure of a trivialisable G -equivariant principal G -bundle over G . Indeed, the G -action on the fibers is by diagonal right multiplication, so that the G -equivariant diffeomorphism $t : (g_1, g_2) \mapsto (g_1 g_2, g_2)$ furnishes a global trivialization, where the trivial G -bundle $p_1 : G \times G \rightarrow G$ over G projects on the first component.

Lemma 3.5.3. *A biconjugacy class in $G \times G$ is the preimage of a conjugacy class in G under the projection $\tilde{\mu}$:*

$$\mathcal{B}_{h_1, h_2} = \tilde{\mu}^{-1}(\mathcal{C}_{h_1 h_2^{-1}}) = \{(g_1, g_2) \in G \times G \mid g_1 g_2^{-1} \in \mathcal{C}_{h_1 h_2^{-1}}\};$$

in particular,

$$\mathcal{B}_{h_1, h_2} = \mathcal{B}_{h_1 h_2^{-1}, e}.$$

Proof. We observe that for every element $(g_1, g_2) \in \mathcal{B}_{h_1, h_2}$ we have $g_1 = x_1 h_1 x_2^{-1}$ and $g_2 = x_1 h_2 x_2^{-1}$ for some $x_1, x_2 \in G$, and hence

$$g_1 g_2^{-1} = x_1 h_1 h_2^{-1} x_1^{-1} \in \mathcal{C}_{h_1 h_2^{-1}}$$

Conversely, given $(g_1, g_2) \in G \times G$ such that there exists some $x \in G$ with $x g_1 g_2^{-1} x^{-1} = h_1 h_2^{-1}$, we set $x_1 := x^{-1}$ and $x_2 := g_2^{-1} x^{-1} h_2$ and obtain $g_1 = x_1 h_1 x_2^{-1}$ and $g_2 = x_1 h_2 x_2^{-1}$, which shows that $(g_1, g_2) \in \mathcal{B}_{h_1, h_2}$. ■

To conclude, biconjugacy classes have the topology of a direct product of G with a conjugacy class. Thus for simply connected groups, they are in particular simply connected.

The next step is to find conditions on the bundle gerbe bimodule of a bi-brane. Motivated by Definition 3.5.1 we would like to fix the curvature of the bi-brane to a canonical 2-form on the biconjugacy class, which is invariant under a natural action. Consider again the map $\tilde{\mu}$ whose restriction maps the bi-conjugacy class \mathcal{B}_{h_1, h_2} to the conjugacy class $\mathcal{C}_{h_1 h_2^{-1}}$. We introduce the two-form

$$\varpi_{h_1, h_2} := \tilde{\mu}^* \omega_{h_1 h_2^{-1}} - \frac{1}{2} \langle p_1^* \theta \wedge p_2^* \theta \rangle$$

on \mathcal{B}_{h_1, h_2} , where p_i , $i = 1, 2$, is the projection from $G \times G \rightarrow G$ on its i th factor, and both summands are restricted to the submanifold \mathcal{B}_{h_1, h_2} of $G \times G$. From the intertwining properties of $\tilde{\mu}$ it follows that the two-form ϖ is invariant under both diagonal actions of G on \mathcal{B}_{h_1, h_2} .

Lemma 3.5.4. *Let G be a Lie group, let $\langle -, - \rangle$ be an Ad-invariant symmetric bilinear form on \mathfrak{g} and let $\eta := \frac{1}{6} \langle \theta \wedge [\theta \wedge \theta] \rangle$ be the associated 3-form on G . Restricted to a biconjugacy class \mathcal{B}_{h_1, h_2} in $G \times G$, we have*

$$p_1^* \eta = p_2^* \eta + d\varpi_{h_1, h_2}$$

Proof. We first recall the relation

$$\tilde{\mu}^* \eta = p_1^* \eta - p_2^* \eta + \frac{1}{2} d \langle p_1^* \theta \wedge p_2^* \theta \rangle$$

which can be derived explicitly, see, e.g. [AMM98]. On the other hand, we find

$$(\tilde{\mu}^* \eta)|_{\mathcal{B}_{h_1, h_2}} = \tilde{\mu}^*(\eta)|_{\mathcal{C}_{h_1 h_2^{-1}}} = \tilde{\mu}^*(d\omega_{h_1 h_2^{-1}}) = d\tilde{\mu}^* \omega_{h_1 h_2^{-1}};$$

together with the definition of ϖ_{h_1, h_2} the last two equations imply the claim. ■

Summarizing, we expect that a symmetric bi-brane that separates Wess-Zumino-Witten models whose target spaces are the same Lie group G , satisfies the following two conditions:

1. its world volume is a biconjugacy class \mathcal{B}_{h_1, h_2} in $G \times G$.
2. its curvature is fixed to be the 2-form ϖ_{h_1, h_2} .

In the next section we find more evidence that the 2-form ϖ_{h_1, h_2} on a biconjugacy class is related to conformal field theories.

3.6 Towards a geometric Realization of the Verlinde Algebra

As mentioned in the introduction to the present chapter, defect lines appear naturally in algebraic approaches to rational conformal field theories [PZ01,

[FRS02]. In the TFT approach [FRS02] a complete description of such defects is available [FFRS04]. It allows one, in particular, to define the *fusion* of two defects and of a defect with a conformal boundary condition. To be a bit more specific, we label by $\{A_1, A_2, \dots\}$ conformal field theories which are compatible in a certain sense. Then there exist defect lines which separate the conformal field theory A_1 present on a region of worldsheet to their left (with respect to the orientation on the defect line) from a conformal field theory A_2 to their right hand side. Such a defect will be denoted by ${}_{A_1}B_{A_2}$. Then the fusion of two defects ${}_{A_1}B_{A_2}$ and ${}_{A_2}B_{A_3}$ yields a defect of type ${}_{A_1}B_{A_3}$:

$${}_{A_1}B_{A_3} = {}_{A_1}B_{A_2} \star_{A_2} {}_{A_2}B_{A_3}.$$

The second type of fusion associates to a defect ${}_{A_1}B_{A_2}$ and boundary condition ${}_{A_2}N$ for the theory A_2 a boundary condition ${}_{A_1}N$ for A_1 ,

$${}_{A_1}N = {}_{A_1}B_{A_2} \star_{A_2} {}_{A_2}N.$$

In the framework of [FRS02], the labels $\{A_1, A_2, \dots\}$ correspond to certain algebras in some representation category. Boundary conditions are described by modules, and defects by bimodules of these algebras; the fusion operation \star_A is realized as the tensor product over A .

We expect that the description of D-branes by bundle gerbe modules and bi-branes by bundle gerbe bi-modules we gave in this chapter has analogous notions of fusion. Recall that we already defined the tensor product between a \mathcal{G}_1 - \mathcal{G}_2 -bimodule and a \mathcal{G}_2 - \mathcal{G}_3 -bimodule and the tensor product between a \mathcal{G}_1 - \mathcal{G}_2 -bimodule and a left \mathcal{G}_2 -module or a right \mathcal{G}_1 -module. However, these bundle gerbes have to be defined over the same manifold, against what the world volumes of symmetric bi-branes and D-branes, namely biconjugacy classes and conjugacy classes, are in general different, even disjoint.

So it is a crucial task to develop fusion rules

$$\mathcal{B}_\alpha \star \mathcal{B}_\beta = \sum_{\gamma} \mathcal{N}_{\alpha\beta}^{\gamma} \mathcal{B}_\gamma \quad (3-13)$$

for symmetric bi-branes in Wess-Zumino-Witten models. As has been seen in the algebraic approach, for these bi-branes there exists a natural notion of duality. It can be characterized by the property that the fusion of a bi-brane and its dual contains the special bi-brane which with respect to fusion acts as the identity. This is the bi-brane whose world volume is the biconjugacy class $\mathcal{B}_{(e,e)}$, i.e. the diagonal $G \subset G \times G$. By invoking this duality, instead of working with the fusion rules (3-13) we consider the multiplicities

$$\mathcal{N}_{\alpha\beta\gamma} := \mathcal{N}_{\alpha\beta}^{\gamma^\vee}.$$

These structure constants are, in general, not symmetric; from the results of the algebraic approach, however, we expect them to be invariant under

cyclic permutations. The algebraic approach also predicts that in the case of compact connected and simply connected Lie groups, the constants $\mathcal{N}_{\alpha\beta}^\gamma$ are just the ordinary fusion multiplicities arising in the chiral theory, which satisfy the Verlinde formula.

We now turn our attention to the fusion $\mathcal{B}_\beta \star \mathcal{C}_\alpha$ of a bi-brane whose world volume is a biconjugacy class $\mathcal{B}_\beta := \tilde{\mu}^{-1}(\mathcal{C}_\beta)$ in $G \times G$, where $\tilde{\mu}$ is as in (3–12), with a D-brane whose world volume is a conjugacy class \mathcal{C}_α of G . To analyze this issue, we work with fusion coefficient $\mathcal{N}_{\alpha\beta\gamma}$: it is the multiplicity of a D-brane with world volume \mathcal{C}_γ in the fusion $\mathcal{B}_\beta \star \mathcal{C}_\alpha$. In the sequel we assume that all group elements are regular, i.e. contained in just a single maximal torus of G . We are thus lead to consider the submanifold

$$\begin{aligned} M_{\alpha\beta\gamma} &:= p_1^{-1}\mathcal{C}_\alpha \cap \tilde{\mu}^{-1}\mathcal{C}_\beta \cap p_2^{-1}\mathcal{C}_\gamma \\ &= \{(g_1, g_2) \in G \times G \mid g_1 \in \mathcal{C}_\alpha, g_2 \in \mathcal{C}_\gamma, g_1 g_2^{-1} \in \mathcal{C}_\beta\} \end{aligned}$$

of $G \times G$. It is equipped with a natural G -action, obtained as the diagonal conjugation on both components. Both D-branes and bi-branes are equipped with two-forms; as a consequence, $M_{\alpha\beta\gamma}$ comes with a natural two-form, namely the sum

$$\omega_{\alpha\beta\gamma} := p_1^*\omega_\alpha|_{M_{\alpha\beta\gamma}} + p_2^*\omega_\gamma|_{M_{\alpha\beta\gamma}} + \varpi_\beta|_{M_{\alpha\beta\gamma}} \quad (3-14)$$

of the restrictions of the three two-forms $p_1^*\omega_\alpha$, $p_2^*\omega_\gamma$ and ϖ_β . According to the results obtained in the algebraic approach, this space should be linked to the fusion rules of the chiral Wess-Zumino-Witten theory at level k . To see how such a relation can exist, we recall that fusion rules are dimensions of spaces of conformal blocks. The latter can be obtained by geometric quantization from suitable moduli spaces of flat connections; as such they arise in the quantization of Chern-Simons theories.

The situation relevant for Verlinde multiplicities is given by the three-punctured sphere S^2 , also known as the „pair of pants“ or trinion. In classical Chern-Simons theory one considers the moduli space of flat connections on S^2 whose monodromy around the three insertion points takes values in conjugacy classes \mathcal{C}_α , \mathcal{C}_β and \mathcal{C}_γ , respectively. Taking the monodromies $g_\alpha \in \mathcal{C}_\alpha$, $g_\beta \in \mathcal{C}_\beta$ and $g_\gamma \in \mathcal{C}_\gamma$ along circles of the same orientation around all three insertions, the relations in the fundamental group of the trinion impose that $g_\alpha g_\beta g_\gamma = 1$. Since monodromies are defined only up to simultaneous conjugation, the moduli space that matters in classical Chern-Simons theory is isomorphic to the quotient $M_{\alpha\beta\gamma}/G$.

Note that the bounds on the range of bi-branes that appear in the fusion are already present before geometric quantization. Indeed, the relevant product

$$\mathcal{C}_h \star \mathcal{C}_{h'} := \{gg' \mid g \in \mathcal{C}_h, g' \in \mathcal{C}_{h'}\} \quad (3-15)$$

of conjugacy classes has already been considered, for $G = \text{SU}(2)$, in [JW92]. It is convenient to characterize a conjugacy class of $\text{SU}(2)$ by its trace or, equivalently, by the angle θ with

$$\cos \theta = \frac{1}{2} \text{tr}(g),$$

which takes values $\theta \in [0, \pi]$. One finds [JW92] that the product (3–15) of the two conjugacy classes with angles θ, θ' is the union of all conjugacy classes with angle θ'' in the range

$$|\theta - \theta'| \leq \theta'' \leq \min\{\theta + \theta', 2\pi - (\theta + \theta')\}.$$

This already yields the correct upper and lower bounds that appear in the $SU(2)$ fusion rules.

A full understanding of fusion can only be expected after applying geometric quantization to the so obtained moduli space: this space must be endowed with a two-form, which is interpreted as the curvature of a line bundle, and the holomorphic sections of this bundle are what results from geometric quantization. In view of this need for quantization it is a highly non-trivial observation that the two-form $\omega_{\alpha\beta\gamma}$ from (3–14) furnished by the two D-branes and the bi-brane is exactly the same as the symplectic form which arises from classical Chern-Simons theory.

Chapter 4

Algebraic Structure for Bundle Gerbes II: Jandl Structures

A long series of algebraic results indicates that two-dimensional conformal field theories can consistently be considered on unorientable surfaces. Early results include a detailed study of the abelian case [BPS92] and of $SU(2)$ [PSS95b, PSS95a]. The success of the algebraic theory of unoriented conformal field theory leads, in the description by Wess-Zumino-Witten models, to the quest for corresponding geometric structures on the target space. From previous work [BCW01, HSS02, Bru02] it is clear that an involution $k : M \rightarrow M$ on the target space will be one ingredient. Examples like the Lie group $SO(3)$, for which two different unoriented Wess-Zumino-Witten models with the same involution k are known, already show that this structure does not suffice.

In this chapter, we define an additional structure for a bundle gerbe which solves this problem. Moreover, we show that it gives rise to a well-defined notion of holonomy for unoriented surfaces in a completely general context.

4.1 Oriented, orientable and unoriented Surfaces

We start with some basic notions concerning orientations on surfaces, i.e. two-dimensional smooth manifolds. In general, an *orientation* on an n -dimensional smooth manifold M is an equivalence class $[\omega]$ of nowhere vanishing n -forms $\omega \in \Omega^n(M)$ under the equivalence relation $\omega' \sim \omega$ if and only if there exists a positive function $f : M \rightarrow \mathbb{R}_{>0}$ with $\omega' = f\omega$. We call a smooth manifold *oriented*, if a specific orientation is chosen, and else *unoriented*. An unoriented manifold is in turn called *orientable*, if an orientation exists, and else *unorientable*. Each connected component of an orientable manifold admits two different choices of an orientation. Examples for orientable smooth manifolds are simply-connected manifolds, almost complex manifolds and Lie groups. Symplectic manifolds are even oriented. A diffeomorphism $f : M \rightarrow N$ between oriented smooth n -dimensional manifolds with orientations represented by n -forms ω_M and ω_N , is called *orientation preserving*, if $f^*\omega_N \sim \omega_M$, and else – provided that M is connected – *orientation-reversing*.

Definition 4.1.1. *An orientation covering of a surface Σ is a double covering $\text{pr} : \hat{\Sigma} \rightarrow \Sigma$ with an oriented surface $\hat{\Sigma}$, such that the canonical involution*

$$\sigma : \hat{\Sigma} \rightarrow \hat{\Sigma}$$

that preserves fibers and permutes the two sheets, is orientation-reversing on each connected component of $\hat{\Sigma}$.

Orientation coverings have two important properties [BG88]:

- (a) it is unique up to orientation-preserving diffeomorphisms of covering spaces.
- (b) under the assumption that Σ is connected, $\hat{\Sigma}$ is connected if and only if Σ is unorientable.

Due to the first point, we denote the unique orientation covering of a surface Σ by $\hat{\Sigma}$. An orientation covering is useful to obtain the following equivalent formulation of an orientation on a surface.

Lemma 4.1.2. *Let Σ be an orientable surface. There is a bijection between orientations $[\omega]$ on Σ and smooth global sections $\text{or} : \Sigma \rightarrow \hat{\Sigma}$ in the orientation covering.*

Now let M be a smooth manifold and let $k : M \rightarrow M$ be an involution on M . By $C^\infty(\hat{\Sigma}, M)^{\sigma, k}$ we denote the space of smooth maps $\hat{\phi} : \hat{\Sigma} \rightarrow M$ for which the diagram

$$\begin{array}{ccc} \hat{\Sigma} & \xrightarrow{\hat{\phi}} & M \\ \sigma \downarrow & & \downarrow k \\ \hat{\Sigma} & \xrightarrow{\hat{\phi}} & M \end{array}$$

is commutative. The maps in $C^\infty(\hat{\Sigma}, M)^{\sigma, k}$ are also called *equivariant*.

Lemma 4.1.3. *Let Σ be an orientable surface and M be a smooth manifold with involution $k : M \rightarrow M$. An orientation on Σ defines a bijection*

$$C^\infty(\hat{\Sigma}, M)^{\sigma, k} \rightarrow C^\infty(\Sigma, M).$$

Proof. Since Σ is orientable, $\hat{\Sigma}$ consists of two disjoint copies of Σ with opposite orientations. An orientation on Σ is a global section $\text{or} : \Sigma \rightarrow \hat{\Sigma}$ in the covering $\text{pr} : \hat{\Sigma} \rightarrow \Sigma$. Now let $\hat{\phi} : \hat{\Sigma} \rightarrow M$ be a map. We define its image as $\phi := \hat{\phi} \circ \text{or}$. On the other hand, given a map $\phi : \Sigma \rightarrow M$, we define the preimage $\hat{\phi}$ on the two sheets of $\hat{\Sigma}$ separately as

$$\hat{\phi}|_{\text{or}(\Sigma)} := \phi \quad \text{and} \quad \hat{\phi}|_{\sigma \text{or}(\Sigma)} := k \circ \phi$$

respectively. ■

Let us now consider the following situation: a sigma model for oriented worldsheets, which is by Definition 1.6.1 a Riemannian manifold M and a bundle gerbe \mathcal{G} . Furthermore, we assume that $k : M \rightarrow M$ is a parity transformation, what means by Definition 1.6.6 that k is an involutive isometry, and that the bundle gerbes $k^*\mathcal{G}$ and \mathcal{G}^* are isomorphic. We have seen that topologically trivial Wess-Zumino-Witten models are examples for this situation. In general, the Feynman amplitude of a smooth map $\phi : \Sigma \rightarrow M$ from a closed oriented conformal surface Σ to M satisfies

$$\mathcal{A}_{g,\mathcal{G}}(\phi, \Sigma) = \mathcal{A}_{g,\mathcal{G}}(k \circ \phi, \bar{\Sigma}) \quad (4-1)$$

where $\bar{\Sigma}$ is the surface with the opposite orientation.

Definition 4.1.4. *A sigma model for orientable worldsheets is a smooth Riemannian manifold (M, g) together with a bundle gerbe \mathcal{G} and a parity transformation k . The Feynman amplitude $\mathcal{A}_{g,\mathcal{G},k}^{\text{orble}}(\hat{\phi}, \Sigma)$ of a smooth equivariant map $\hat{\phi} \in C^\infty(\hat{\Sigma}, M)^{\sigma,k}$, where Σ is a closed, orientable conformal surface, is obtained as follows: choose any orientation on Σ , and let $\phi : \Sigma \rightarrow M$ be the smooth map corresponding to $\hat{\phi}$ under the bijection from Lemma 4.1.3. Then,*

$$\mathcal{A}_{g,\mathcal{G},k}^{\text{orble}}(\hat{\phi}, \Sigma) := \mathcal{A}_{g,\mathcal{G}}(\phi, \Sigma).$$

This amplitude is well-defined: if we had chosen a different orientation, the fact that the map $\hat{\phi}$ is equivariant and (4-1) assure that we get the same value.

Note that any sigma model for *orientable* worldsheets can be regarded as a sigma model for closed and *oriented* worldsheets in such a way that the amplitudes coincide,

$$\mathcal{A}_{g,\mathcal{G}}(\phi, \Sigma) = \mathcal{A}_{g,\mathcal{G},k}^{\text{orble}}(\hat{\phi}, \Sigma). \quad (4-2)$$

Conversely, not any sigma model for oriented worldsheets can be regarded as a sigma model for orientable worldsheets: one has to choose an additional information, namely a parity transformation k . This choice does not have to exist, and if it exists, it may not be unique, as discussed in §1.6 for topologically trivial Wess-Zumino-Witten models.

To see that the choice of a parity transformation is not yet enough to define a Feynman amplitude for unorientable surfaces, let us make a naive attempt. In a situation where we can not choose an orientation like in Definition 4.1.4, we use the following generalization of an orientation.

Definition 4.1.5. *Let Σ be a closed surface and $\hat{\Sigma}$ its orientation covering. A fundamental domain for Σ in $\hat{\Sigma}$ is a submanifold $F \subset \hat{\Sigma}$, possibly with (piecewise smooth) boundary, satisfying*

$$F \cap \sigma(F) = \partial F \quad \text{and} \quad F \cup \sigma(F) = \hat{\Sigma}.$$

This is a generalization of an orientation on Σ in the sense, that the global section $\text{or} : \Sigma \rightarrow \hat{\Sigma}$ associated to any orientation by Lemma 4.1.2 defines a fundamental domain, namely $F := \text{or}(\Sigma)$, one of the two copies of Σ in $\hat{\Sigma}$. Unlike global sections, however, fundamental domains exist for arbitrary closed surfaces, as we shall prove next.

We show the existence of a fundamental domain for an arbitrary closed surface Σ by an explicit construction, which we will also use in §4.4. Let $\mathcal{U} = \{U_i\}_{i \in I}$ be an open cover of Σ , chosen small enough to admit local sections $\text{or}_i : U_i \rightarrow \hat{\Sigma}$. One can think of such sections as *local orientations*. Let T be a dual triangulation of Σ , subordinate to the cover \mathcal{U} by a map $\text{map} : T \rightarrow I$. So, for each face $f \in T$ there is an index $i(f)$ with $f \subset U_{i(f)}$, as well as for each edge $e \in T$ and for each vertex $v \in T$. Because we have a dual triangulation, each vertex is trivalent.

Consider a common edge $e = f_1 \cap f_2$ of two faces f_1 and f_2 . We call the edge e *orientation-preserving*, if

$$\text{or}_{i(f_1)}(e) = \text{or}_{i(f_2)}(e),$$

otherwise we call it *orientation-reversing*. So the set of edges splits in a set \bar{E} of orientation-preserving, and a set \bar{E} of orientation-reversing edges. If v is a vertex, the number of orientation-reversing edges ending in v must be even, and since we started with a dual triangulation, it is either zero or two. Hence, the edges contained in \bar{E} form non-intersecting closed lines in Σ . We define the subset

$$F := \bigcup_{f \in T} \text{or}_{i(f)}(f)$$

of $\hat{\Sigma}$ as shown in Figure 4.1 and endow it with the subspace topology. The boundary of F is exactly the union of the preimages of orientation-reversing edges under the covering map,

$$\partial F = \bigcup_{e \in \bar{E}} \text{pr}^{-1}(e),$$

and hence a disjoint union of piecewise smooth circles. This shows that F is a submanifold of $\hat{\Sigma}$ with piecewise smooth boundary. It satisfies the two properties of a fundamental domain, and hence shows its existence.

Now, the first attempt to generalize the definition of the Feynman amplitude given in Definition 4.1.4 to unorientable surfaces is the following: instead of choosing an orientation, we choose a fundamental domain F of Σ in $\hat{\Sigma}$. Then we take the Feynman amplitude of the smooth map $\hat{\phi}|_F : F \rightarrow M$, defined on the oriented surface F . However, F is a surface with boundary, and the Wess-Zumino term is not well-defined, as discussed in §3.1. Nevertheless, the boundary ∂F has an important property concerning its orientation, which is induced from the orientation of F , see Figure 4.2.

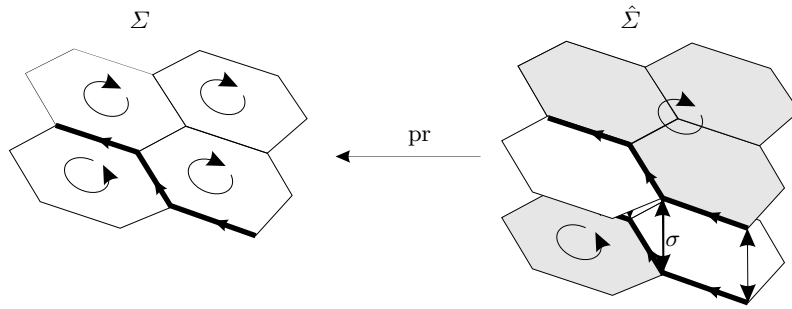

Figure 4.1: The construction of a fundamental domain F (shaded grey). Local orientations decide which of the two preimages of a face in the orientation covering belongs to F .

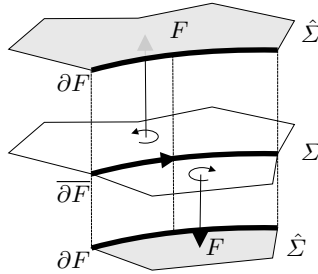

Figure 4.2: The orientation on $\overline{\partial F}$.

Lemma 4.1.6. *The quotient $\overline{\partial F} := \partial F/\sigma$ is a one-dimensional oriented closed submanifold of Σ .*

Proof. We act with σ on property (i) of the fundamental domain F :

$$\sigma(\partial F) = \sigma(F \cap \sigma(F)) = F \cap \sigma(F) = \partial F$$

This shows that σ restricts to an involution on ∂F . Since σ acts on $\hat{\Sigma}$ without fixed points, the quotient $\partial F/\sigma$ is a submanifold of Σ , and as ∂F is closed, so is the quotient. The orientation of $\hat{\Sigma}$ induces an orientation on F . Because σ is orientation-reversing, the orientation of $\sigma(F)$ is opposite to the one induced on $\sigma(F)$ as a submanifold of $\hat{\Sigma}$. Hence, ∂F and $\partial(\sigma(F))$ are equal as sets as well as as oriented submanifolds. Thus σ preserves the orientation on ∂F . ■

Notice that one could already see the orientation of $\overline{\partial F}$ in Figure 4.1 for the fundamental domain constructed from an oriented triangulation. Let us

finally remark that we can not apply the D-brane-formalism described in §3.1 in a reasonable way to fix the problem with the boundary of F : we would have to demand that the map $\hat{\phi}$ sends ∂F into the world volume Q of a D-brane. But since the position of ∂F changes with different choices of F , we would have to choose $Q = M$. This would mean that the bundle gerbe \mathcal{G} is flat and that its Dixmier-Douady class is torsion.

4.2 Jandl Structures on Bundle Gerbes

In this section, we introduce the above-mentioned additional structure for a bundle gerbe, that is to provide a well-defined notion of holonomy for un-oriented surfaces. It exists whenever there are sufficiently well-behaved 1-isomorphisms between the pullback bundle gerbe $k^*\mathcal{G}$ and the dual bundle gerbe \mathcal{G}^* . The formal similarity to the Jandl structures in [FRS04] becomes apparent, if one realizes that the dual bundle gerbe plays the role of the opposed algebra. For this reason, we term the additional structure a *Jandl structure* on the bundle gerbe. The relation to the austrian poet Erich Jandl comes from the fact that on unoriented worldsheets there is no distinction between right and left movers, in contrast to oriented surfaces described in §1.6. This situation is indicated in the following poem [Jan95]:

*manche meinen
lechts und rinks
kann man nicht
velwechsern.
werch ein illtum!*

For translations into english, see [Wal00].

In a first attempt we assume that the additional structure is the choice of a 1-isomorphism $\mathcal{A} : k^*\mathcal{G} \rightarrow \mathcal{G}^*$. However, a detailed calculation shows that it is not enough to choose any such 1-isomorphism. It shows that the 1-isomorphism \mathcal{A} itself has to be equivariant in a certain sense. To give a complete definition of the Jandl structure we conveniently use the 2-categorical language we have introduced in Chapter 2 of this thesis.

Definition 4.2.1. *A Jandl structure \mathcal{J} on a bundle gerbe \mathcal{G} over M is a collection $(k, \mathcal{A}, \varphi)$ of an involution $k : M \rightarrow M$, a 1-isomorphism*

$$\mathcal{A} : k^*\mathcal{G} \rightarrow \mathcal{G}^*$$

and a 2-isomorphism

$$\varphi : k^*\mathcal{A} \Rightarrow \mathcal{A}^*,$$

that satisfies $k^\varphi = \varphi^{*-1}$.*

Let us briefly relate Definition 4.2.1 to the original definition of a Jandl structure, as given in [SSW07] without using the 2-categorical language. For this purpose we elaborate the details of Definition 4.2.1. We denote the pullback of the surjective submersion $\pi : Y \rightarrow M$ along k by $\pi_k : Y_k \rightarrow M$; for simplicity we take $Y_k := Y$ and $\pi_k := k \circ \pi$. Now, we assume by Theorem 2.4.1 that the 1-isomorphism \mathcal{A} consists of a line bundle A over $P := Y_k \times_M Y$. The exchange map $s : Y \times_M Y_k \rightarrow Y_k \times_M Y$ is an involution of P which lifts k ,

$$\begin{array}{ccc} P & \xrightarrow{s} & P \\ p \downarrow & & \downarrow p \\ M & \xrightarrow{k} & M, \end{array}$$

where $p : P \rightarrow M$ is the projection on the second factor. The dual 1-isomorphism \mathcal{A}^* has, following its definition from §2.5, the line bundle s^*A over P . Now, similarly as for the pullback of $\pi : Y \rightarrow M$ we denote the pullback of $p : P \rightarrow M$ by $p_k : P_k \rightarrow M$ and choose $P_k := P$ and $p_k := k \circ p$. This way, the pullback 1-isomorphism $k^*\mathcal{A}$ has the line bundle A over P . Again by Theorem 2.4.1, we assume that the 2-isomorphism φ can be represented by a triple $(P, \text{id}_P, \varphi_P)$ with an isomorphism $\varphi_P : A \rightarrow s^*A$ of line bundles over P satisfying the compatibility axiom (2M) with the isomorphism α of \mathcal{A} :

$$\begin{array}{ccc} L \otimes \zeta_2^* A & \xrightarrow{\alpha} & \zeta_1^* A \otimes L \\ \text{id} \otimes \zeta_2^* \varphi_P \downarrow & & \downarrow \zeta_1^* \varphi_P \otimes \text{id} \\ L \otimes \zeta_2^* s^* A & \xrightarrow{s^* \alpha} & \zeta_1^* s^* A \otimes L \end{array}$$

The dual 2-isomorphism φ^* is represented by $(P, \text{id}_P, s^* \varphi_P)$, and the equation $k^* \varphi = \varphi^{*-1}$ becomes $\varphi_P = s^* \varphi_P^{-1}$. So, φ_P is an s -equivariant structure on the line bundle A . This is exactly the original definition [SSW07]: a 1-isomorphism $\mathcal{A} : k^* \mathcal{G} \rightarrow \mathcal{G}^*$, whose line bundle A is equipped with an s -equivariant structure which is compatible with the isomorphism α of \mathcal{A} in the sense of the commutativity of the above diagram.

Definition 4.2.2. A *morphism* $\beta : \mathcal{J} \rightarrow \mathcal{J}'$ between Jandl structures $\mathcal{J} = (k, \mathcal{A}, \varphi)$ and $\mathcal{J}' = (k, \mathcal{A}', \varphi')$ on the same bundle gerbe \mathcal{G} over M with the same involution k is a 2-morphism

$$\beta : \mathcal{A} \Rightarrow \mathcal{A}'$$

which commutes with φ and φ' in the sense that the diagram

$$\begin{array}{ccc} \mathcal{A} & \xrightarrow{\varphi} & k^* \mathcal{A}^* \\ \beta \Downarrow & & \Downarrow k^* \beta^* \\ \mathcal{A}' & \xrightarrow{\varphi'} & k^* \mathcal{A}'^* \end{array}$$

of 2-morphisms is commutative.

Since \mathcal{A} is invertible, every morphism of Jandl structures is invertible. We may thus speak of a groupoid $\mathfrak{J}\mathfrak{d}\mathfrak{l}(\mathcal{G}, k)$ of Jandl structures on the bundle gerbe \mathcal{G} with involution k . As always when there is an additional structure to choose, one would like to know how many inequivalent choices there are.

To see this, it is worthwhile to consider a Jandl structure $\mathcal{J} = (k, \mathcal{A}, \varphi)$ on a trivial bundle gerbe \mathcal{I}_ρ . By definition, this is a 1-isomorphism

$$\mathcal{A} : \mathcal{I}_{k^*\rho} \rightarrow \mathcal{I}_{-\rho}$$

and a 2-isomorphism $\varphi : k^*\mathcal{A} \Rightarrow \mathcal{A}^*$ satisfying $k^*\varphi = \varphi^{*-1}$. Now we apply the functor Bun from Proposition 2.4.5 and obtain a line bundle $\hat{R} := \text{Bun}(\mathcal{A})$ over M of curvature $-(\rho + k^*\rho)$ and, from the properties of Bun from Proposition 2.5.1 an isomorphism $\hat{\varphi} := \text{Bun}(\varphi) : k^*\hat{R} \rightarrow \hat{R}$ of line bundles over M which satisfies $k^*\hat{\varphi} = \hat{\varphi}^{-1}$, summarizing: a k -equivariant line bundle. So, the functor Bun induces an equivalence of groupoids

$$\text{Bun}_\rho^k : \mathfrak{J}\mathfrak{d}\mathfrak{l}(\mathcal{I}_\rho, k) \rightarrow \mathfrak{L}\mathfrak{i}\mathfrak{n}_{-(\rho+k^*\rho)}^k(M)$$

between the groupoid of Jandl structures on \mathcal{I}_ρ with involution k and the groupoid of k -equivariant line bundles over M with curvature $-(\rho + k^*\rho)$.

Recall that by Theorem 2.5.4 the groupoid $\mathfrak{I}\mathfrak{s}\mathfrak{o}(\mathcal{G}, \mathcal{H})$ of isomorphisms between two bundle gerbes is a torsor category over the monoidal groupoid $\mathfrak{L}\mathfrak{i}\mathfrak{n}_0(M)$ of flat line bundles over M . For Jandl structures we have the following refinement.

Theorem 4.2.3. *The groupoid $\mathfrak{J}\mathfrak{d}\mathfrak{l}(\mathcal{G}, k)$ of Jandl structures on a bundle gerbe \mathcal{G} with respect to the involution $k : M \rightarrow M$ is a torsor category over the monoidal groupoid $\mathfrak{L}\mathfrak{i}\mathfrak{n}_0^k(M)$ of flat k -equivariant line bundles over M .*

Proof. First we notice that the monoidal 2-functor \otimes on the 2-category $\mathfrak{B}\mathfrak{G}\mathfrak{r}\mathfrak{b}(M)$ induces a tensor product

$$\otimes : \mathfrak{J}\mathfrak{d}\mathfrak{l}(\mathcal{G}, k) \times \mathfrak{J}\mathfrak{d}\mathfrak{l}(\mathcal{H}, k) \rightarrow \mathfrak{J}\mathfrak{d}\mathfrak{l}(\mathcal{G} \otimes \mathcal{H}, k)$$

in a straightforward manner. In this context, the equivalence of groupoids $\text{Bun}_0^k : \mathfrak{J}\mathfrak{d}\mathfrak{l}(\mathcal{I}_0, k) \rightarrow \mathfrak{L}\mathfrak{i}\mathfrak{n}_0^k(M)$ deduced above is even a monoidal equivalence. This endows $\mathfrak{J}\mathfrak{d}\mathfrak{l}(\mathcal{G}, k)$ with the structure of a module category by

$$\mathfrak{L}\mathfrak{i}\mathfrak{n}_0^k(M) \times \mathfrak{J}\mathfrak{d}\mathfrak{l}(\mathcal{G}, k) \xrightarrow{(\text{Bun}_0^k)^{-1} \times \text{id}} \mathfrak{J}\mathfrak{d}\mathfrak{l}(\mathcal{I}_0, k) \times \mathfrak{J}\mathfrak{d}\mathfrak{l}(\mathcal{G}, k) \xrightarrow{\otimes} \mathfrak{J}\mathfrak{d}\mathfrak{l}(\mathcal{G}, k),$$

and we have to prove that the canonical functor

$$\mathfrak{L}\mathfrak{i}\mathfrak{n}_0^k(M) \times \mathfrak{J}\mathfrak{d}\mathfrak{l}(\mathcal{G}, k) \longrightarrow \mathfrak{J}\mathfrak{d}\mathfrak{l}(\mathcal{G}, k) \otimes \mathfrak{J}\mathfrak{d}\mathfrak{l}(\mathcal{G}, k)$$

is an equivalence of categories. Since morphisms of Jandl structures are just 2-isomorphisms, the fully faithfulness follows directly from Theorem 2.5.4. To

see that it is essentially surjective, let $(k, \mathcal{A}, \varphi)$ and $(k, \mathcal{A}', \varphi')$ be two Jandl structures on \mathcal{G} . By Theorem 2.5.4, we obtain a flat line bundle L over M as the difference between \mathcal{A} and \mathcal{A}' , together with an isomorphism $\phi : k^*L \rightarrow L$ as the difference between φ and φ' . The properties of φ and φ' induce the equivariance of ϕ . This way we have obtained a flat k -equivariant line bundle over M , whose action on $(k, \mathcal{A}, \varphi)$ gives a Jandl structure on \mathcal{G} isomorphic to $(k, \mathcal{A}', \varphi')$. ■

In particular, the set of equivalence classes of Jandl structures on \mathcal{G} with involution $k : M \rightarrow M$ is a torsor over the group $\text{Pic}_0^k(M)$ of isomorphism classes of k -equivariant flat line bundles over M .

In general, for an action of a finite group Γ on M , recall the following facts concerning Γ -equivariant line bundles. There are two obstructions for a given line bundle L to admit equivariant structures: the first depends on the bundle and the group action, namely that

$$x^*L \otimes L^* \cong \mathbb{1}, \quad (4-3)$$

for all $x \in \Gamma$, which is still to be understood as an equation of hermitian line bundles with unitary connection. The second obstruction is a class in the group cohomology group $H_\Gamma^2(\text{U}(1))$. Now, if both obstructions vanish and M is connected, the possible equivariant structures are parameterized by the group cohomology group $H_\Gamma^1(\text{U}(1))$. For the group $\text{Pic}^\Gamma(M)$ of isomorphism classes of Γ -equivariant line bundles over M there is an equivariant version of the exact sequence from Proposition 1.3.9, namely [Gom03]

$$0 \longrightarrow H_\Gamma^1(M, \text{U}(1)) \longrightarrow \text{Pic}^\Gamma(M) \longrightarrow \Omega^2(M)^\Gamma .$$

Here, $H_\Gamma^1(M, \text{U}(1))$ is the Γ -equivariant cohomology of M , i.e. the cohomology of the associated Borel space. In particular, we get for *flat* equivariant line bundles

$$\text{Pic}_0^\Gamma(M) \cong H_\Gamma^1(M, \text{U}(1)). \quad (4-4)$$

In our case of an involution $k : M \rightarrow M$, regarded as an action of $\Gamma = \mathbb{Z}_2$ on M , the group cohomology groups appearing above are

$$H_{\mathbb{Z}_2}^1(\text{U}(1)) = \mathbb{Z}_2 \quad \text{and} \quad H_{\mathbb{Z}_2}^2(\text{U}(1)) = 0$$

so that the second obstruction vanishes, and every line bundle L , which satisfies the remaining obstruction (4-3) admits exactly two k -equivariant structures. In particular, this applies to the trivial line bundle $\mathbb{1}$ itself. We exhibit its two equivariant structures explicitly. We have to choose an isomorphism

$$\varphi : k^*\mathbb{1} \rightarrow \mathbb{1}$$

of line bundles such that $k^*\varphi = \varphi^{-1}$. The two choices are either $\varphi_1 = \text{id}$ or $\varphi_{-1} : (x, z) \mapsto (x, -z)$. We denote $\mathbb{1}$ together with the equivariant structure

φ_1 by $\mathbb{1}_1^k$. It represents the unit element of $\text{Pic}_0^{\mathbb{Z}^2}(M)$. We denote $\mathbb{1}$ together with the equivariant structure φ_{-1} by $\mathbb{1}_{-1}^k$. Notice that $\mathbb{1}_{-1}^k \otimes \mathbb{1}_{-1}^k = \mathbb{1}_1^k$ as equivariant line bundles. Hence $\mathbb{1}_{-1}^k$ represents a non-trivial element of order two in $\text{Pic}_0^{\mathbb{Z}^2}(M)$. The whole discussion is completely independent of M , so $\text{Pic}_0^{\mathbb{Z}^2}(M)$ always contains at least these two elements. As a consequence, if a bundle gerbe \mathcal{G} admits a Jandl structure \mathcal{J} , then $\mathbb{1}_{-1}^k \otimes \mathcal{J}$ is another, inequivalent Jandl structure on \mathcal{G} .

Proposition 4.2.4. *Let M be a 2-connected smooth manifold with an involution $k : M \rightarrow M$ and let \mathcal{G} be a bundle gerbe over M , whose curvature $H := \text{curv}(\mathcal{G})$ satisfies*

$$k^*H = -H.$$

Then there exist exactly two non-isomorphic Jandl structures on \mathcal{G} .

Proof. Since M is simply-connected, there is only one flat line bundle up to isomorphism, namely the trivial one. As just discussed, it gives rise to two different elements in $\text{Pic}_0^k(M)$, corresponding to two non-isomorphic Jandl structures by Theorem 4.2.3.

To show the existence, recall that by Corollary 1.3.10 iv) and with $H^2(M, \text{U}(1)) = 0$ the bundle gerbes $k^*\mathcal{G}$ and \mathcal{G}^* have to be stably isomorphic, since their curvatures coincide. So, let $\mathcal{A} : k^*\mathcal{G} \rightarrow \mathcal{G}^*$ be any 1-isomorphism. The 1-isomorphisms $k^*\mathcal{A}$ and \mathcal{A}^* are both objects in the (non-empty) groupoid $\mathfrak{Iso}(\mathcal{G}, k^*\mathcal{G}^*)$ which is a torsor category over the monoidal groupoid $\mathfrak{Lin}_0(M)$ of flat line bundles over M by Theorem 2.5.4. Since M is simply-connected, $k^*\mathcal{A}$ and \mathcal{A}^* are isomorphic. Let $\varphi : k^*\mathcal{A} \Rightarrow \mathcal{A}^*$ be any 2-isomorphism. In general, it will not satisfy the required identity $k^*\varphi = \varphi^{*-1}$ but $k^*\varphi \circ \varphi^* : k^*\mathcal{A}^* \Rightarrow k^*\mathcal{A}^*$ is some 2-isomorphism. Since the identity $\text{id}_{k^*\mathcal{A}^*}$ is another one, by the torsor argument they differ by an isomorphism ϕ of the trivial flat line bundle over M . Since M is connected, this is a complex number c . The choice of any square root of c defines another isomorphism of the trivial flat line bundle, whose action on φ produces another 2-isomorphism $\varphi' : k^*\mathcal{A} \Rightarrow \mathcal{A}^*$ which satisfies $k^*\varphi' = \varphi'^{-1}$. ■

Let us also derive local expressions for a Jandl structure $\mathcal{J} = (k, \mathcal{A}, \varphi)$ on a bundle gerbe \mathcal{G} . We simplify the situation by considering an open cover $\mathfrak{V} = \{V_i\}_{i \in I}$ of M , which is equivariant under k , i.e. there exists an involution $k : I \rightarrow I$ of the index set such that $k(V_i) = V_{ki}$, and which is still good enough to enable us to extract cocycles.

Let $\xi = (g, A, B) \in \text{Tot}^2(\mathfrak{V}, \mathcal{D}(2))$ be a cocycle for the bundle gerbe \mathcal{G} , so that we can choose $-\xi$ for the dual bundle gerbe \mathcal{G}^* , and $k^*\xi$ for $k^*\mathcal{G}$. Here, for example, $(k^*B)_i = k^*(B_{ki})$. As further described in sections §1.2 and §2.6 the 1-isomorphism $\mathcal{A} : k^*\mathcal{G} \rightarrow \mathcal{G}^*$ gives rise to a cochain $\beta = (t, W) \in \text{Tot}^1(\mathfrak{V}, \mathcal{D}(2))$ with

$$-\xi = k^*\xi + D\beta, \tag{4-5}$$

or equivalently and in more detail:

$$\begin{aligned}
-B_i &= k^* B_i + dW_i \\
-A_{ij} &= k^* A_{ij} - d\log(t_{ij}) + W_j - W_i \\
g_{ijk}^{-1} &= k^* g_{ijk} \cdot t_{jk} \cdot t_{ik}^{-1} \cdot t_{ij}
\end{aligned}$$

Next, let $\alpha = (j) \in \text{Tot}^0(\mathfrak{A}, \mathcal{D}(2))$ be a cocycle for the 2-isomorphism $\varphi : k^* \mathcal{A} \Rightarrow \mathcal{A}^*$,

$$-\beta = k^* \beta + D\alpha, \quad (4-6)$$

or in turn equivalently

$$\begin{aligned}
-W_i &= k^* W_i + d\log(j_i) \\
t_{ij}^{-1} &= k^* t_{ij} \cdot j_j \cdot j_i^{-1}.
\end{aligned}$$

The condition $k^* \varphi = \varphi^{*-1}$ translates to

$$k^* \alpha = \alpha^{-1}. \quad (4-7)$$

It is clear that a morphism $\beta : \mathcal{J} \rightarrow \mathcal{J}'$ of Jandl structures over \mathcal{G} with local data (β, α) and (β', α') respectively induces a cochain $\tau \in \text{Tot}^0(\mathfrak{A}, \mathcal{D}(2))$ with $\beta' = \beta + D\tau$ and $k^* \tau \cdot \alpha = \alpha' \cdot \tau$.

We will use these cochains in §4.3 where we give a local formula for the unoriented surface holonomy. In Chapter 5 we develop more systematically a cohomology theory which describes bundle gerbes with Jandl structures and more general, bundle gerbes with twisted equivariant structures.

While we have so far considered Jandl structures on a fixed bundle gerbe, we will now discuss relations between Jandl structures on different bundle gerbes.

Proposition 4.2.5. *Let \mathcal{G} and \mathcal{G}' be bundle gerbes over M and let k be an involution on M . Any 1-isomorphism $\mathcal{B} : \mathcal{G} \rightarrow \mathcal{G}'$ induces an equivalence of groupoids*

$$J_{\mathcal{B}} : \mathfrak{J}\mathfrak{D}(\mathcal{G}', k) \rightarrow \mathfrak{J}\mathfrak{D}(\mathcal{G}, k)$$

with the following properties:

- a) any 2-morphism $\beta : \mathcal{B} \Rightarrow \mathcal{B}'$ induces a natural equivalence $J_{\mathcal{B}} \cong J_{\mathcal{B}'}$.
- b) there is a natural equivalence $J_{\text{id}_{\mathcal{G}}} \cong \text{id}_{\mathfrak{J}\mathfrak{D}(\mathcal{G}, k)}$.
- c) it respects the composition of 1-morphisms in the sense that

$$J_{\mathcal{B}' \circ \mathcal{B}} = J_{\mathcal{B}} \circ J_{\mathcal{B}'}$$

- d) the functors $J_{\mathcal{B}}$ and $J_{\mathcal{B}^{-1}}$ are weak inverses.

Proof. The functor $J_{\mathcal{B}}$ sends a Jandl structure $(k, \mathcal{A}, \varphi)$ on \mathcal{G}' to the triple $(k, \mathcal{A}', \varphi')$ with the same involution k , the 1-isomorphism

$$\mathcal{A}' := \mathcal{B}^* \circ \mathcal{A} \circ k^* \mathcal{B} : k^* \mathcal{G} \rightarrow \mathcal{G}^*$$

and the 2-isomorphism

$$\begin{aligned} k^* \mathcal{A}' &= k^* \mathcal{B}^* \circ k^* \mathcal{A} \circ \mathcal{B} \\ &\Downarrow \text{id}_{k^* \mathcal{B}^*} \circ \varphi \circ \text{id}_{\mathcal{B}} \\ k^* \mathcal{B}^* \circ \mathcal{A}' \circ \mathcal{B} &= k^* \mathcal{A}'^* \end{aligned}$$

where we use the properties of dual 1-morphisms derived in §2.5. The following calculation shows that $(k, \mathcal{A}', \varphi')$ is a Jandl structure:

$$\begin{aligned} k^* \varphi'^* &= k^* (\text{id}_{k^* \mathcal{B}^*} \circ \varphi \circ \text{id}_{\mathcal{B}})^* \\ &= \text{id}_{k^* \mathcal{B}^*} \circ k^* \varphi^* \circ \text{id}_{\mathcal{B}} \\ &= \text{id}_{\mathcal{B}} \circ \varphi^{-1} \circ \text{id}_{\mathcal{B}^*} \\ &= \varphi'^{-1}. \end{aligned}$$

A morphism β of Jandl structures on \mathcal{G}' is sent to the morphism

$$J_{\mathcal{B}}(\beta) := \text{id}_{\mathcal{B}^*} \circ \beta \circ \text{id}_{k^* \mathcal{B}}$$

of the respective Jandl structures on \mathcal{G}' . The two axioms of the composition functor \circ from Lemma 2.2.4 show that the composition of morphisms of Jandl structures is respected, so that $J_{\mathcal{B}}$ is a functor. It is an equivalence because $J_{\mathcal{B}^{-1}}$ is an inverse functor, where the natural equivalences $J_{\mathcal{B}^{-1}} \circ J_{\mathcal{B}} \cong \text{id}$ and $J_{\mathcal{B}} \circ J_{\mathcal{B}^{-1}} \cong \text{id}$ use the 2-isomorphisms i_r and i_l from §2.3 associated to the inverse 1-morphism \mathcal{B}^{-1} .

To prove a), let $\beta : \mathcal{B} \Rightarrow \mathcal{B}'$ be a 2-morphism. We define the natural equivalence $J_{\mathcal{B}} \cong J_{\mathcal{B}'}$, which is a collection of morphisms $\beta_{\mathcal{J}} : J_{\mathcal{B}}(\mathcal{J}) \rightarrow J_{\mathcal{B}'}(\mathcal{J})$ of Jandl structures on \mathcal{G} for any Jandl structure \mathcal{J} on \mathcal{G}' by

$$\beta_{\mathcal{J}} := \beta^* \circ \text{id}_{\mathcal{A}} \circ k^* \beta.$$

This defines indeed a morphism of Jandl structures and makes the naturality square

$$\begin{array}{ccc} J_{\mathcal{B}}(\mathcal{J}) & \xrightarrow{\beta_{\mathcal{J}}} & J_{\mathcal{B}'}(\mathcal{J}) \\ J_{\mathcal{B}}(\beta) \downarrow & & \downarrow J_{\mathcal{B}'}(\beta) \\ J_{\mathcal{B}}(\mathcal{J}') & \xrightarrow{\beta_{\mathcal{J}'}} & J_{\mathcal{B}'}(\mathcal{J}') \end{array}$$

commutative. The natural equivalence for b) uses the 2-isomorphisms $\lambda_{\mathcal{A}}$ and $\rho_{\mathcal{A}}$ of the 2-category $\mathfrak{BGrb}(M)$ and the fact that $\text{id}_{\mathcal{G}}^* = \text{id}_{\mathcal{G}^*}$. Finally, c) follows from the definition of $J_{\mathcal{B}}$ and the fact that the duality functor $(\)^*$ respects the composition of 1-morphisms, as derived in §2.5. d) follows from b) and c). \blacksquare

We call a pair of a bundle gerbe \mathcal{G} over M and a Jandl structure \mathcal{J} on \mathcal{G} a *Jandl gerbe* over M .

Definition 4.2.6. *Two Jandl gerbes $(\mathcal{G}, \mathcal{J})$ and $(\mathcal{G}', \mathcal{J}')$ are called equivalent, if there exists a 1-isomorphism $\mathcal{B} : \mathcal{G} \rightarrow \mathcal{G}'$ and a morphism $\beta : \mathcal{J} \Rightarrow J_{\mathcal{B}}(\mathcal{J}')$ of Jandl structures on \mathcal{G} .*

It follows from Proposition 4.2.5 that this is indeed an equivalence relation. There is one important point to notice: if \mathcal{J} and \mathcal{J}' are Jandl structures on a bundle gerbe \mathcal{G} , the Jandl gerbes $(\mathcal{G}, \mathcal{J})$ and $(\mathcal{G}, \mathcal{J}')$ may be equivalent, although there is no morphism $\mathcal{J} \Rightarrow \mathcal{J}'$ of Jandl structures on \mathcal{G} . This is the case only if there exists an automorphism $\mathcal{B} : \mathcal{G} \rightarrow \mathcal{G}$ which is not isomorphic to the identity $\text{id}_{\mathcal{G}}$.

4.3 Unoriented Surface Holonomy

We recall that we have found a canonical equivalence of groupoids

$$\text{Bun}_{\rho}^k : \mathfrak{J}\mathfrak{Dl}(\mathcal{I}_{\rho}, k) \rightarrow \mathfrak{Lin}_{-(\rho+k^*\rho)}^k(M)$$

between the groupoid of Jandl structures with involution k on the trivial bundle gerbe \mathcal{I}_{ρ} and the groupoid of k -equivariant line bundles over M with curvature $-(\rho + k^*\rho)$. In particular, if \mathcal{G} is a bundle gerbe over M and $\mathcal{T} : \mathcal{G} \rightarrow \mathcal{I}_{\rho}$ a trivialization, by Proposition 4.2.5 we obtain a functor

$$\mathfrak{J}\mathfrak{Dl}(\mathcal{G}, k) \xrightarrow{J_{\mathcal{T}^{-1}}} \mathfrak{J}\mathfrak{Dl}(\mathcal{I}_{\rho}, k) \xrightarrow{\text{Bun}_{\rho}^k} \mathfrak{Lin}_{-(\rho+k^*\rho)}^k(M)$$

converting a Jandl structure on the bundle gerbe \mathcal{G} into a k -equivariant line bundle over M .

Definition 4.3.1. *Let $(\mathcal{G}, \mathcal{J})$ be a Jandl gerbe over M with involution $k : M \rightarrow M$, let Σ be a closed surface and let $\hat{\phi} \in C^{\infty}(\hat{\Sigma}, M)^{\sigma, k}$ be an equivariant smooth map. For a trivialization*

$$\mathcal{T} : \hat{\phi}^* \mathcal{G} \rightarrow \mathcal{I}_{\rho}$$

let \hat{R} be the σ -equivariant line bundle over $\hat{\Sigma}$ determined by the functor

$$\text{Bun}_{\sigma}^{\rho} \circ J_{\mathcal{T}^{-1}} : \mathfrak{J}\mathfrak{Dl}(\hat{\phi}^* \mathcal{G}, \sigma) \rightarrow \mathfrak{Lin}_{-(\rho+\sigma^*\rho)}^{\sigma}(\hat{\Sigma}),$$

In turn, \hat{R} defines by its equivariant structure a line bundle R over Σ . Let F be a fundamental domain of Σ in $\hat{\Sigma}$. Then,

$$\text{Hol}_{\mathcal{G}, \mathcal{J}}(\hat{\phi}, \Sigma) := \exp\left(2\pi i \int_F \rho\right) \cdot \text{Hol}_R(\overline{\partial F})$$

is the unoriented surface holonomy of the Jandl gerbe $(\mathcal{G}, \mathcal{J})$ around the equivariant smooth map $\hat{\phi} : \hat{\Sigma} \rightarrow M$.

Notice that we have used that $\overline{\partial F}$ is oriented and closed by Lemma 4.1.6. It is important to see that the definition of unoriented surface holonomy does not depend on the two choices: the one of the fundamental domain F and the one of the trivialization \mathcal{T} . First, let F' be another fundamental domain. We define the set

$$B := \text{Int}(F) \cap \sigma(\text{Int}(F')),$$

where Int denotes the interior. As the intersection of two open sets, B is open and hence a submanifold of $\hat{\Sigma}$. It contains those parts of F , which are not contained in F' , see Figure 4.3. Because we excluded the boundaries of F and

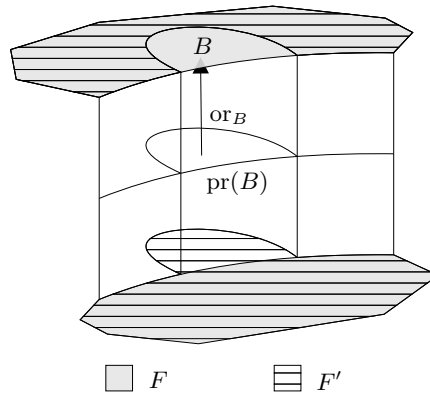

Figure 4.3: The difference B between two fundamental domains F and F' .

F' , we have an empty intersection

$$B \cap \sigma(B) = \emptyset,$$

such that there is a unique section $\text{or}_B : \text{pr}(B) \rightarrow \hat{\Sigma}$ with image B . From Figure 4.3, we have

$$\int_{F'} \rho = \int_F \rho - \int_B \rho + \int_{\sigma(B)} \rho = \int_F \rho + \int_B \text{curv}(\hat{R}),$$

since σ is orientation-reversing. By Stokes's Theorem, the exponential of the integral of the curvature of \hat{R} over B is nothing but the holonomy of that line bundle around ∂B . Thus,

$$\exp\left(2\pi i \int_B \text{curv}(\hat{R})\right) = \text{Hol}_{\hat{R}}(\partial B) = \text{Hol}_R(\text{pr}(\partial B)).$$

This is the term which is compensated by the change in the boundary term:

$$\mathrm{Hol}_R(\overline{\partial F'})^{-1} = \mathrm{Hol}_R(\overline{\partial F}) \cdot \mathrm{Hol}_R(\mathrm{pr}(\partial B))^{-1}.$$

In summary, Definition 4.3.1 is independent of the choice of the fundamental domain.

Now, secondly, let $T' : \hat{\phi}^* \mathcal{G} \rightarrow \mathcal{I}_{\rho'}$ be any other trivialization. We consider the 1-isomorphism

$$\mathcal{B} := T \circ T'^{-1} : \mathcal{I}_{\rho'} \rightarrow \mathcal{I}_{\rho}$$

and the corresponding line bundle $T := \mathrm{Bun}(\mathcal{B})$. To compare the two σ -equivariant line bundles \hat{R} and \hat{R}' corresponding to the two trivializations, we first compare the Jandl structures $J_{T^{-1}}(\mathcal{J})$ on \mathcal{I}_{ρ} and $J_{T'^{-1}}(\mathcal{J})$ on $\mathcal{I}_{\rho'}$. By Proposition 4.2.5 a), b) and c), there exists an isomorphism

$$J_{T'^{-1}}(\mathcal{J}) \cong J_{\mathcal{B}}(J_{T^{-1}}(\mathcal{J}))$$

of Jandl structures on \mathcal{I}_{ρ} . By definition of the functor $J_{\mathcal{B}}$, this isomorphism is a 2-isomorphism

$$\mathcal{A}' \cong \mathcal{B}^* \circ \mathcal{A} \circ \sigma^* \mathcal{B},$$

where \mathcal{A} is the 1-morphism of $J_{T^{-1}}(\mathcal{J})$ and \mathcal{A}' is the 1-morphism of $J_{T'^{-1}}(\mathcal{J})$. Now we apply the functor Bun and obtain an isomorphism

$$\hat{R}' \cong T \otimes \hat{R} \otimes \sigma^* T$$

of σ -equivariant line bundles over $\hat{\Sigma}$, where $\hat{Q} := \sigma^* T \otimes T$ has the canonical σ -equivariant structure by exchanging the tensor factors. Thus, we have isomorphic line bundles

$$R' \cong R \otimes Q$$

over Σ . Notice that the holonomy of the line bundle Q is

$$\mathrm{Hol}_Q(\overline{\partial F}) = \mathrm{Hol}_T(\partial F) = \exp \left(2\pi i \int_F \rho - \rho' \right)$$

This shows

$$\begin{aligned} \exp \left(2\pi i \int_F \rho' \right) \cdot \mathrm{Hol}_{R'}(\overline{\partial F}) &= \exp \left(2\pi i \int_F \rho' \right) \cdot \mathrm{Hol}_Q(\overline{\partial F}) \cdot \mathrm{Hol}_R(\overline{\partial F}) \\ &= \exp \left(2\pi i \int_F \rho \right) \cdot \mathrm{Hol}_R(\overline{\partial F}) \end{aligned}$$

so that Definition 4.3.1 does not depend on the choice of the trivialization. So we have assured that unoriented surface holonomy is well-defined.

Proposition 4.3.2. *Let Σ be a closed surface and $\hat{\phi} : \hat{\Sigma} \rightarrow M$ be an equivariant smooth map. Unoriented surface holonomy has the following properties:*

i) *If $(\mathcal{G}, \mathcal{J})$ and $(\mathcal{G}', \mathcal{J}')$ are equivalent Jandl gerbes,*

$$\mathrm{Hol}_{\mathcal{G}, \mathcal{J}}(\hat{\phi}, \Sigma) = \mathrm{Hol}_{\mathcal{G}', \mathcal{J}'}(\hat{\phi}, \Sigma).$$

ii) If Σ is orientable, unoriented surface holonomy coincides, for any choice of an orientation, with oriented surface holonomy from Definition 1.5.2,

$$\text{Hol}_{\mathcal{G}, \mathcal{J}}(\hat{\phi}, \Sigma) = \text{Hol}_{\mathcal{G}}(\phi, \Sigma),$$

where ϕ and $\hat{\phi}$ are related by the bijection of Lemma 4.1.3.

Proof. i) Let \mathcal{J} and \mathcal{J}' be two isomorphic Jandl structures on \mathcal{G} . Then, also the two k -equivariant line bundles \hat{R} and \hat{R}' are isomorphic and thus determine isomorphic line bundles R and R' over Σ , whose holonomies coincide. If now $\mathcal{B} : \mathcal{G} \rightarrow \mathcal{G}'$ is a 1-isomorphism, and one has chosen a trivialization $\mathcal{T} : \hat{\phi}^* \mathcal{G}' \rightarrow \mathcal{I}_\rho$ to derive $\text{Hol}_{\mathcal{G}', \mathcal{J}'}(\hat{\phi}, \Sigma)$, the claim follows if one chooses the trivialization $\mathcal{T} \circ \hat{\phi}^* \mathcal{B}$ in the derivation of $\text{Hol}_{\mathcal{G}, \mathcal{J}}(\hat{\phi}, \Sigma)$.

ii) Let $\text{or} : \Sigma \rightarrow \hat{\Sigma}$ be a choice of an orientation on Σ . Then $F := \text{or}(\Sigma)$ is a fundamental domain with empty boundary $\partial F = \emptyset$. For any trivialization \mathcal{T} of $\hat{\phi}^* \mathcal{G}$ one obtains

$$\text{Hol}_{\mathcal{G}, \mathcal{J}}(\hat{\phi}, \Sigma) = \exp \left(2\pi i \int_{\text{or}(\Sigma)} \rho \right),$$

Because $\hat{\phi}$ and ϕ correspond to each other, $\text{or}^* \hat{\phi}^* \mathcal{G}$ is the same gerbe as $\phi^* \mathcal{G}$, and $\text{or}^* \mathcal{T}$ is a trivialization with 2-form $\text{or}^* \rho$. Thus, the right hand side is equal to $\exp 2\pi i \int_{\Sigma} \text{or}^* \rho$ and therefore coincides with the ordinary holonomy. ■

In the next section we derive a local formula for the unoriented surface holonomy of a Jandl gerbe.

4.4 Local Description of unoriented Surface Holonomy

Let $\mathfrak{V} = \{V_i\}_{i \in I}$ be a good open cover of M . We assume again that it is invariant under the involution $k : M \rightarrow M$ as in §4.2. Let (g, A, B) be a cochain for the bundle gerbe \mathcal{G} and $((t, W), j)$ be cochains for the Jandl structure \mathcal{J} , extracted as explained in §4.2. We pull back the cover \mathfrak{V} along a smooth equivariant map $\hat{\phi} : \hat{\Sigma} \rightarrow M$ and obtain a cover $\{\hat{U}_i\}_{i \in I}$ with $\hat{U}_i := \hat{\phi}^{-1}(V_i)$, together with pullback cochains of the bundle gerbe and its Jandl structure. Next, we choose a cochain (h, M) for a trivialization \mathcal{T} of the pullback gerbe and a 2-form $\rho \in \Omega^2(\hat{\Sigma})$, so that

$$(1, 0, \rho) = \hat{\phi}^*(g, A, B) + D(h, M) \quad (4-8)$$

holds. Combining the definition of the functor $\mathcal{J}_{\mathcal{T}}$ from Proposition 4.2.5 with results from §2.6,

$$(r, R) := \hat{\phi}^*(t, W) - \sigma^*(h, M) - (h, M)$$

is a cochain for the σ -equivariant line bundle \hat{R} over $\hat{\Sigma}$.

Because $\hat{\phi}$ is equivariant, the pullback cover is invariant under σ . Hence it projects to a cover of Σ with open sets $U_i := \text{pr}(\hat{U}_i)$. We choose local sections $\text{or}_i : U_i \rightarrow \hat{\Sigma}$ and a dual triangulation T of Σ , subordinate to the cover $\{U_i\}_{i \in I}$, together with a subordinating map $i : T \rightarrow I$. As we explained in §4.1 we choose the fundamental domain

$$F := \bigcup_{f \in T} \text{or}_{i(f)}(f),$$

where the f 's are the faces of the triangulation.

We now introduce three abbreviations in order to simplify forthcoming expressions. Let $\omega_i^2 \in \Omega^2(\hat{U}_i)$, $\omega_{ij}^1 \in \Omega^1(\hat{U}_i \cap \hat{U}_j)$ and $\omega_{ijk} : \hat{U}_i \cap \hat{U}_j \cap \hat{U}_k \rightarrow \text{U}(1)$ be some local forms and functions. First we denote their integral over a face f by

$$I_f(\omega, \omega^1, \omega^2) := \exp \left(2\pi i \int_{\text{or}_{i(f)}(f)} \omega_{i(f)}^2 + 2\pi i \sum_{e \in \partial f} \int_{\text{or}_{i(f)}(e)} \omega_{i(f)i(e)}^1 \right) \cdot \prod_{v \in \partial e} \omega_{i(f)i(e)i(v)}^{\varepsilon(f,e,v)}(\text{or}_{i(f)}(v)),$$

where $\varepsilon(f, e, v) \in \{1, -1\}$ indicates, whether v is the end or the starting point of the edge e with respect to the orientation $\text{or}_{i(f)}$.

Second, we denote the integral of some local 1-forms $\omega_i^1 \in \Omega^1(\hat{U}_i)$ and functions $\omega_{ij} : \hat{U}_i \cap \hat{U}_j \rightarrow \text{U}(1)$ along an edge e of a face f by

$$I_{e,f}(\omega, \omega^1) := \exp \left(2\pi i \int_{\text{or}_{i(f)}(e)} \omega_{i(e)}^1 \right) \cdot \prod_{v \in \partial e} \omega_{i(e)i(v)}^{\varepsilon(f,e,v)}(\text{or}_{i(f)}(v)).$$

Recall that the set of edges in T splits into the set E of orientation-preserving edges and the set \bar{E} of orientation-reversing edges. For an orientation-preserving edge $e \in f_1 \cap f_2$ we have

$$I_{e,f_1}(\omega, \omega^1) = I_{e,f_2}(\omega, \omega^1)^{-1}, \quad (4-9)$$

while for an orientation-reversing edge

$$I_{e,f_1}(\omega, \omega^1) = I_{e,f_2}(\sigma^* \omega, \sigma^* \omega^1)$$

holds. In the latter case, since e is orientation-reversing, we have either $\text{or}_{i(e)}(e) = \text{or}_{i(f_1)}(e)$ or $\text{or}_{i(e)}(e) = \text{or}_{i(f_2)}(e)$, so that we can write just $I_e(\omega, \omega^1)$, where the for f the choice of the face with the coinciding orientation is understood.

Third, if v is a vertex of an edge e , we define for some smooth function $\omega_i : \hat{U}_i \rightarrow \text{U}(1)$

$$I_{v,e,f}(\omega) := \omega_{i(v)}^{\varepsilon(f,e,v)}(\text{or}_{i(f)}(v)).$$

If now v is the common vertex of two orientation-reversing edges $e_1, e_2 \in \bar{E}$, we call v orientation-preserving, if $\text{or}_{i(e_1)}(v) = \text{or}_{i(e_2)}(v)$ and orientation-reversing otherwise. Let us denote the set of orientation-reversing vertices by \bar{V} . If v is such a vertex, we just write $I_v(\omega)$ instead of $I_{v,e,f}(\omega)$, where for e the choice of the edge as well as for f the face with the coinciding orientation is understood.

Now the first factor in the holonomy formula from Definition 4.3.1 is

$$\exp\left(\text{i} \int_F \rho\right) = \exp\left(2\pi\text{i} \sum_{f \in T} \int_{\text{or}_{i(f)}(f)} \hat{\phi}^* B_{i(f)} + \text{d}M_{i(f)}\right).$$

Just as in the derivation of the local formula for ordinary surface holonomy in §1.5, using Stokes's Theorem, equation (4–8) and our abbreviations, we end up with

$$\exp\left(\text{i} \int_F \rho\right) = \prod_{f \in T} I_f(\hat{\phi}^* g, \hat{\phi}^* A, \hat{\phi}^* B) \cdot \prod_{f \in T} \prod_{e \in \partial f} I_{e,f}(h, M)^{-1}. \quad (4-10)$$

Here the second factor collects the boundary contributions that appear in the application of Stokes's Theorem.

Let us assume for the moment that Σ was oriented, and all sections or_i coincide with the global orientation restricted to U_i . In this situation, we have only orientation preserving edges, and each of them appears twice in the second factor. Since the contributions are inverse by (4–9), the second factor vanishes. We obtain the local holonomy formula expressed only by the local data of the bundle gerbe, as in §1.5.

If Σ is not oriented, the second factor still consists of two contributions for each orientation-reversing edge $e \in \bar{E}$, which are

$$I_{e,f_1}(h, M) \cdot I_{e,f_2}(h, M) = I_e(h \cdot \sigma^* h, M + \sigma^* M).$$

Hence, in the general case, the second factor of (4–10) is

$$\prod_{f \in T} \prod_{e \in \partial f} I_{e,f}(h, M)^{-1} = \prod_{e \in \bar{E}} I_e(h \cdot \sigma^* h, M + \sigma^* M)^{-1}. \quad (4-11)$$

For the second factor of the holonomy formula from Definition 4.3.1 we have to compute the holonomy of the quotient line bundle R around $\partial \bar{F}$. It is easy to see that this holonomy is equal to the parallel transport of \hat{R} around the open line

$$\hat{E} := \bigcup_{e \in \bar{E}} \text{or}_{i(e)}(e),$$

where at the boundary points the equivariant structure of \hat{R} is used, this is

$$\mathrm{Hol}_R(\overline{\partial F}) = \prod_{e \in \bar{E}} I_e(r, R) \cdot \prod_{v \in \bar{V}} I_v(\hat{\phi}^* j).$$

Since e is orientation-reversing,

$$\begin{aligned} I_e(r, R) &= I_e(\hat{\phi}^* t \cdot \sigma^* h^{-1} \cdot h^{-1}, \hat{\phi}^* W - \sigma^* M - M) \\ &= I_e(\hat{\phi}^* t, \hat{\phi}^* W) \cdot I_e(h \cdot \sigma^* h, M + \sigma^* M)^{-1}. \end{aligned}$$

The second factor cancels (4–11) so that all the local data coming from the trivialization drops out. It remains

$$\mathrm{Hol}_{\mathcal{G}, \mathcal{J}}(\Sigma, \hat{\phi}) = \prod_{f \in T} I_f(\hat{\phi}^* g, \hat{\phi}^* A, \hat{\phi}^* B) \cdot \prod_{e \in \bar{E}} I_e(\hat{\phi}^* t, \hat{\phi}^* W)^{-1} \cdot \prod_{v \in \bar{V}} I_v(\hat{\phi}^* j),$$

depending only on the cocycle for the bundle gerbe and the cochains for the Jandl structure. We visualize this formula in Figure 4.4.

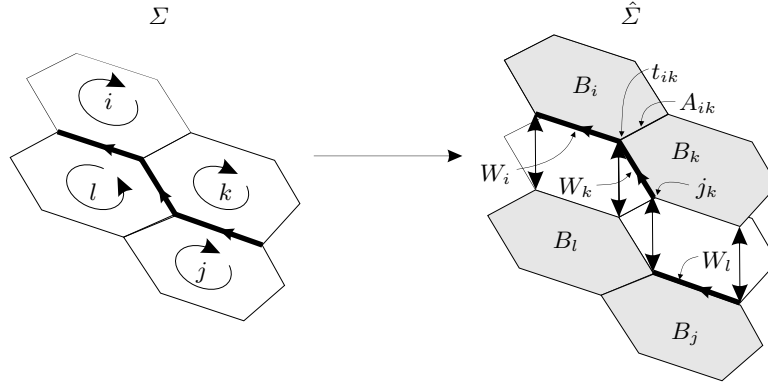

Figure 4.4: Assignment of local data of a Jandl gerbe to a triangulated surface Σ with local orientations.

In the remainder of this section we will apply the local formula for unoriented surface holonomy that we have just derived to two examples of surfaces Σ . For this purpose, it is enough to start with the pullback gerbe $\hat{\phi}^* \mathcal{G}$ which allows us to choose a triangulation adapted to Σ (and not to M).

Example 4.4.1 (The Klein bottle). We think of the Klein bottle as a rectangle with the identifications of the boundary as indicated by arrows in Figure 4.5. The identification by the vertical arrows is orientation-preserving, while the one by the horizontal arrows is orientation-reversing. Note that the dual triangulation shown in Figure 4.5 is a triangulation with only one face. We



Figure 4.5: A Klein bottle (left) and a dual triangulation with one face (right).

choose a local section from that face into the double cover, and define the fundamental domain F as its image, as shown in Figure 4.6. Here we dropped the arrows, but the identifications are still to be understood, so that both points labelled by v are identified. This means, that we can choose the local

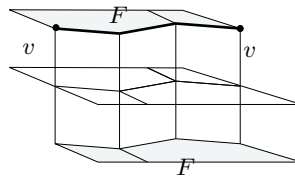

Figure 4.6: A fundamental domain for the Klein bottle in its orientation covering.

orientations of the edges such that the orientation-reversing edges form a closed line, as indicated by the thick line. So there is no orientation-reversing vertex, and the local datum j of the Jandl structure is not relevant for the holonomy around the Klein bottle.

Example 4.4.2 (The real projective plane). We proceed in the same way as for the Klein bottle, we thus think of the real projective plane $\mathbb{R}P^2$ as a two-gon

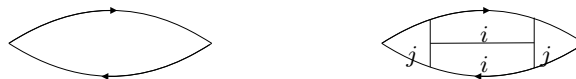

Figure 4.7: The real projective plane (left) and a dual triangulation with two faces (right).

with the identification on the boundary indicated by the arrows in Figure 4.7. The identification is orientation-reversing. An example of a dual triangulation is also shown in Figure 4.7. Now we choose local sections from these two faces

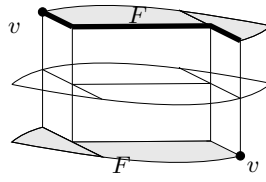

Figure 4.8: A fundamental domain of the real projective plane in its double covering.

into the double cover, for example as shown in Figure 4.8. Note that here the thick line is not closed in $\hat{\Sigma}$, and v is an orientation-reversing vertex. According to the local holonomy formula here the local datum j of the Jandl structure enters in the holonomy.

4.5 Application: Sigma Models for unoriented Surfaces

In the first section of this chapter we generalized the sigma model for oriented worldsheets to orientable worldsheets by the choice of an additional structure, namely a parity transformation $k : M \rightarrow M$ of the target space, i.e. an involutive isometry such that $k^*\mathcal{G}$ and \mathcal{G}^* are 1-isomorphic. We have argued that already the sigma model for orientable surfaces suggests to consider equivariant maps $\hat{\phi} \in C^\infty(\hat{\Sigma}, M)^{\sigma, k}$ instead of maps $\phi : \Sigma \rightarrow M$. We then have discovered that the choice of a parity transformation is not sufficient to make the Wess-Zumino term well-defined for unoriented surfaces. It suffices however for the kinetic term, as we shall see next.

We define the kinetic term for an equivariant smooth map $\hat{\phi}$ in such a way that it reduces – if Σ is orientable, for any choice of an orientation – to the kinetic term $S_g^{\text{kin}}(\phi)$ of the map ϕ corresponding to $\hat{\phi}$ by Lemma 4.1.3. Note that the Lagrangian

$$\mathcal{L}(\hat{\phi}) := \frac{1}{2}g \left(d\hat{\phi} \wedge \star d\hat{\phi} \right)$$

is a 2-form on $\hat{\Sigma}$, which satisfies

$$\sigma^* \mathcal{L}(\hat{\phi}) = -\mathcal{L}(\hat{\phi}), \tag{4-12}$$

because σ is orientation-reversing and k is an isometry of g . This property tells us that $\mathcal{L}(\hat{\phi})$ defines a *2-density* $\mathcal{L}_{\text{den}}(\hat{\phi})$ [BT82, BG88] on Σ . The integral of a 2-density over a surface is well-defined without the necessity of an orientation, in particular for unorientable surfaces. We write

$$S_g^{\text{kin}}(\hat{\phi}) := \int_{\Sigma} \mathcal{L}_{\text{den}}(\hat{\phi})$$

for this integral. With the choice of a fundamental domain F of Σ in $\hat{\Sigma}$, one can make it explicit, even without using the theory of densities, Namely,

$$\int_{\Sigma} \mathcal{L}_{\text{den}}(\hat{\phi}) := \int_F \mathcal{L}(\hat{\phi}).$$

It is easy to see that due to the property (4–12) this does not depend on the choice of F . Furthermore, if Σ is orientable, for any choice $\text{or} : \Sigma \rightarrow \hat{\Sigma}$ and $F := \text{or}(\Sigma)$, we find

$$S_g^{\text{kin}}(\hat{\phi}) = \int_F \mathcal{L}(\hat{\phi}) = \int_{\Sigma} \mathcal{L}(\phi) = S_g^{\text{kin}}(\phi)$$

as required.

To define the Wess-Zumino term for a smooth equivariant map $\hat{\phi} \in C^\infty(\hat{\Sigma}, M)^{\sigma, k}$ we use the theory of Jandl structures and unoriented surface holonomy developed in this chapter. So we amend the choice of a parity transformation k to a complete Jandl structure $\mathcal{J} = (k, \mathcal{A}, \varphi)$, and are then able to define the non-linear sigma model for unoriented, and in particular unorientable worldsheets.

Definition 4.5.1. *A sigma model for unoriented worldsheets is a smooth Riemannian manifold (M, g) together with a Jandl gerbe $(\mathcal{G}, \mathcal{J})$, whose involution $k : M \rightarrow M$ is an isometry. The Feynman amplitude of an equivariant smooth map $\hat{\phi} \in C^\infty(\hat{\Sigma}, M)^{\sigma, k}$, where Σ is a closed and conformal surface, is defined by*

$$\mathcal{A}_{g, \mathcal{G}, \mathcal{J}}^{\text{unor}}(\hat{\phi}, \Sigma) := \exp\left(2\pi i S_g^{\text{kin}}(\hat{\phi})\right) \cdot \text{Hol}_{\mathcal{G}, \mathcal{J}}(\hat{\phi}, \Sigma).$$

According to the definition of both factors, if Σ is orientable, we have

$$\mathcal{A}_{g, \mathcal{G}, \mathcal{J}}^{\text{unor}}(\hat{\phi}, \Sigma) = \mathcal{A}_{g, \mathcal{G}, k}^{\text{orble}}(\hat{\phi}, \Sigma).$$

If Σ is even oriented, by (4–2) we have

$$\mathcal{A}_{g, \mathcal{G}, \mathcal{J}}^{\text{unor}}(\hat{\phi}, \Sigma) = \mathcal{A}_{g, \mathcal{G}}(\phi, \Sigma).$$

In this sense, Definition 4.5.1 generalizes the former definitions of sigma models, namely Definition 4.1.4 from §4.1 and in particular Definition 1.6.1 from §1.6.

The natural notion of gauge equivalence between sigma models for unoriented worldsheets would be the equivalence of the respective Jandl gerbes according to Definition 4.2.6. By Proposition 4.3.2 i) this implies that the respective Feynman amplitudes are equal. However, it turns out that – by purely physical reasons – the correct notion of equivalent sigma models for unoriented worldsheets is weaker.

To explain this, let $\mathcal{B} : \mathcal{G} \rightarrow \mathcal{G}'$ be a 1-isomorphism between two Jandl gerbes $(\mathcal{G}, \mathcal{J})$ and $(\mathcal{G}', \mathcal{J}')$ over M with the same involution k . We recall from Theorem 4.2.3 that the two Jandl structures $J_{\mathcal{A}}(\mathcal{J}')$ and \mathcal{J} on \mathcal{G} differ by the action of a k -equivariant flat line bundle L on M , and that on any manifold there is a flat equivariant line bundle $\mathbb{1}_{-1}^k$ which is trivializable but has a non-trivial k -equivariant structure.

Definition 4.5.2. *Two sigma models for unoriented worldsheets on the same target space (M, g) , and Jandl gerbes $(\mathcal{G}, \mathcal{J})$ and $(\mathcal{G}', \mathcal{J}')$ with the same involution k are called gauge equivalent, if there exists a 1-isomorphism $\mathcal{A} : \mathcal{G} \rightarrow \mathcal{G}'$ and either a morphism*

$$J_{\mathcal{A}}(\mathcal{J}') \Rightarrow \mathcal{J} \quad \text{or} \quad J_{\mathcal{A}}(\mathcal{J}') \Rightarrow \mathbb{1}_{-1}^k \otimes \mathcal{J}$$

of Jandl structures on \mathcal{G} .

We will now investigate the difference between the Feynman amplitudes of gauge equivalent sigma models for unoriented worldsheets. For this purpose, let $\{V_i\}_{i \in I}$ be a good open cover of M , and let (α, β) be cochains for the Jandl structure \mathcal{J} as explained in §4.2. According to the definition of the groupoid $\mathfrak{J}\mathfrak{D}(\mathcal{G}, k)$ as a module category over $\mathfrak{L}\mathfrak{in}_0(M)$, it follows that $(-\alpha, \beta)$ are cochains for the Jandl structure $\mathbb{1}_{-1}^k \otimes \mathcal{J}$, so that only the cochain α changes. Now observe the occurrences of $\alpha = (j)$ in the local holonomy formula from §4.4: it appears for each orientation-reversing vertex $v \in \bar{V}$. Following our example of the real projective plane in the same section, this happens in the presence of a *crosscap*. We conclude that the amplitudes of a smooth equivariant map $\hat{\phi} : \hat{\Sigma} \rightarrow M$ in equivalent sigma models for unoriented worldsheets are either equal or differ by a sign for each crosscap in Σ .

In the sequel, we discuss three examples, namely Wess-Zumino-Witten models with target spaces $SU(2)$ and $SO(3)$, and sigma models with target space $T^2 = S^1 \times S^1$.

Example 4.5.3. We consider a topologically trivial Wess-Zumino-Witten model with the 2-connected target space $SU(2)$ at some fixed level. Following our general discussion in §1.6, the parity transformations are given by $k(g) := g^{-1}$ and $k(g) := -g^{-1}$, where -1 is the non-trivial element in the center of $SU(2)$. The same involutions have been considered in [HSS02, Bru02, BCW01]. Since the curvature H of the bundle gerbe \mathcal{G} satisfies $k^*H = -H$ for both parity transformations, by Proposition 4.2.4 there exist two non-isomorphic Jandl structures \mathcal{J} and \mathcal{J}' on \mathcal{G} with $\mathbb{1}_{-1}^k \otimes \mathcal{J} = \mathcal{J}'$. Separately for each k , they give rise to equivalent non-linear sigma models according to Definition 4.5.2. Hence we have all together two non-equivalent Wess-Zumino-Witten models for unoriented worldsheets on $SU(2)$ for each level, the number coming from the choice of two different involutions. This is in agreement with the results of [PSS95a, PSS95b] and also matches the general results we derive in Chapter 5.

Example 4.5.4. We consider the Wess-Zumino-Witten model with target space $\mathrm{SO}(3)$ at some fixed level. Since $\mathrm{SO}(3)$ is not simply-connected, it is topologically non-trivial. The center of $\mathrm{SO}(3)$ is trivial, so that we have only one parity transformation to consider, namely $k(g) := g^{-1}$. We assume here that the bundle gerbe \mathcal{G} admits Jandl structures; we will see in Chapter 5 that this is the case if and only if the level is even. To classify the Jandl structures, by Theorem 4.2.3 we have to investigate the group $\mathrm{Pic}_0^k(\mathrm{SO}(3))$ of flat equivariant line bundles. This is possible in a very explicit way: with $\pi_1(\mathrm{SO}(3)) = \mathbb{Z}_2$ we have

$$\mathrm{Hom}(\pi_1(\mathrm{SO}(3)), \mathrm{U}(1)) = \mathrm{Hom}(\mathbb{Z}_2, \mathrm{U}(1)) = \mathbb{Z}_2,$$

so there are - up to isomorphism - two flat line bundles: as $\mathrm{SO}(3)$ is the quotient of $\mathrm{SU}(2)$ by the map $q : \mathrm{SU}(2) \rightarrow \mathrm{SU}(2) : g \mapsto -g$, the two flat line bundles over $\mathrm{SO}(3)$ are quotients of the two equivariant flat line bundles over $\mathrm{SU}(2)$, namely $\mathbb{1}_1^q$ and $\mathbb{1}_{-1}^q$, see §4.2. Clearly, $\mathbb{1}_1^q$ descends to the trivial flat line bundle $\tilde{\mathbb{1}}$ on $\mathrm{SO}(3)$, which admits equivariant structures, more precisely, according to the discussion in §4.2, there are two of them. $\mathbb{1}_{-1}^q$ descends to a non-trivial flat line bundle \tilde{L} on $\mathrm{SO}(3)$, and we have to ask whether it admits k -equivariant structures. This is equivalent to the condition, that

$$d\tilde{L} := k^*\tilde{L} \otimes \tilde{L}^* \cong \tilde{\mathbb{1}}. \quad (4-13)$$

Now $d\tilde{L}$ is a flat line bundle, and hence either isomorphic to \tilde{L} or to $\tilde{\mathbb{1}}$. Because $\mathrm{Pic}_0(\mathrm{SO}(3))$ is a group of order two, we have $\tilde{L} \otimes \tilde{L} = \tilde{\mathbb{1}}$. The assumption $d\tilde{L} \cong \tilde{L}$ would therefore mean $k^*\tilde{L} \cong \tilde{\mathbb{1}}$ which is a contradiction since $\tilde{\mathbb{1}}$ is the trivial bundle and $k^*\tilde{L}$ is not. Hence (4-13) is true, and \tilde{L} admits two equivariant structures. All together, there are four equivariant flat line bundles over $\mathrm{SO}(3)$ and hence four non-isomorphic Jandl structures on \mathcal{G} .

Now it is a crucial question whether two of them give rise to equivalent Jandl gerbes $(\mathcal{G}, \mathcal{J})$ and $(\mathcal{G}, \mathcal{J}')$ or not. This would be possible because $\mathfrak{Aut}(\mathcal{G})$ is a torsor category over $\mathfrak{Sin}_0(M)$ by Theorem 2.5.4, whose skeleton contains two elements, represented by $\tilde{\mathbb{1}}$ and \tilde{L} . So it contains a non-trivial automorphism $\mathcal{B} := \tilde{L} \otimes \mathrm{id}_{\mathcal{G}}$ and we have to identify the Jandl gerbes $(\mathcal{G}, \mathcal{J})$ and $(\mathcal{G}, \mathcal{J}')$ if $J_{\mathcal{B}}(\mathcal{J}') \cong \mathcal{J}$, four two of the four non-isomorphic Jandl structures we have found. This is actually not the case: following the definition of $J_{\mathcal{B}}$, the 1-isomorphism \mathcal{A} of the Jandl structure \mathcal{J}' is changed to $(k^*\tilde{L} \otimes \tilde{L}^*) \otimes \mathcal{A}$, so, by (4-13), by a trivializable line bundle. Hence \mathcal{J}' and $J_{\mathcal{B}}(\mathcal{J}')$ are isomorphic Jandl structures, and $J_{\mathcal{B}}(\mathcal{J}') \cong \mathcal{J}$ is only possible if the Jandl structures \mathcal{J} and \mathcal{J}' are isomorphic. Thus we have four inequivalent Jandl gerbes with underlying bundle gerbe \mathcal{G} on $\mathrm{SO}(3)$.

After the identification according to Definition 4.5.2, there remain two gauge equivalence classes of Wess-Zumino-Witten models for unoriented surfaces on $\mathrm{SO}(3)$ for each even level. Again, this is in agreement with [PSS95a, PSS95b], and with our results from Chapter 5.

Example 4.5.5. We discuss a sigma model for unoriented worldsheets whose target space is the torus T^2 . For dimensional reasons, its bundle gerbe is

trivializable (and flat), so we assume $\mathcal{G} = \mathcal{I}_B$ for some 2-form $B \in \Omega^2(T^2)$, the B-field or *Kalb-Ramond-field*. We want to discuss the parity transformation $k = \text{id}$, which allows us to make contact with the discussion in [BPS92]. We recall from §4.2 that we have an equivalence between the groupoid of Jandl structures on a trivial bundle gerbe and the groupoid of equivariant line bundles, which here is

$$\text{Bun}_B^{\text{id}} : \mathfrak{J}\mathfrak{Dl}(\mathcal{I}_B, \text{id}) \rightarrow \mathfrak{Lin}_{-2B}^{\text{id}}(T^2).$$

A sufficient condition for the existence of a line bundle with curvature $2B$ is that $2B$ has integral class. Then, by Proposition 1.3.9 v), the set of isomorphism classes of such line bundles is a torsor over $H^1(T^2, \text{U}(1))$, which is $\text{U}(1) \times \text{U}(1)$. Note that both obstructions for equivariant structures on these line bundles vanish: the first (4-3) because $k = \text{id}$ and the second because $H_{\mathbb{Z}_2}(\text{U}(1)) = 0$. So the set of isomorphism classes of Jandl structures is parameterized by $\mathbb{Z}_2 \times \text{U}(1) \times \text{U}(1)$. One obtains the same result using the classification (4-4) of flat equivariant line bundles by equivariant cohomology: the Borel space associated to the trivial action is $T_K^2 = E\mathbb{Z}_2 \times_{\mathbb{Z}_2} T^2$. With $E\mathbb{Z}_2/\mathbb{Z}_2 = B\mathbb{Z}_2 = \mathbb{R}P^\infty$ we have

$$\begin{aligned} H_K^1(T^2, \text{U}(1)) &= H^1(T_K^2, \text{U}(1)) \\ &= H^1(\mathbb{R}P^\infty, \text{U}(1)) \oplus H^1(T^2, \text{U}(1)) \\ &= \mathbb{Z}_2 \times \text{U}(1) \times \text{U}(1). \end{aligned}$$

Thus we have derived the quantization condition that the Kalb-Ramond-field B has half integer valued periods. This condition was originally found in [BPS92] by an analysis of the bulk spectrum of right and left movers.

Chapter 5

Twisted Equivariant Bundle Gerbes and finite Group Cohomology

In the previous chapters we have discussed sigma models for oriented worldsheets defined by a bundle gerbe over the target space. We have introduced algebraic structures on bundle gerbes in order to study sigma models for worldsheets with boundary and defects and for unoriented worldsheets, namely D-branes, bi-branes and Jandl structures. An important tool to discuss a sigma model on a target space X is to regard so-called orbifold models, certain sigma models on a smooth manifold M whose quotient by a finite group Z is X .

In general, bundle gerbes over a quotient manifold $X = M/Z$ can be obtained from bundle gerbes over M equipped with a Z -equivariant structure [GR02]. In this chapter, we introduce the notion of a twisted equivariant structure. We enhance the Z -action on M in such a way that the quotient X is naturally equipped with an involution; moreover, the twist in the equivariant structure gives rise to a Jandl structure on the quotient bundle gerbe over X with this involution.

To classify twisted equivariant bundle gerbes, we invent a new cohomology theory based on Deligne cohomology and finite group cohomology. We compute the obstructions against twisted equivariant structures and their classifying groups for all the bundle gerbes over compact, simple and simply-connected Lie groups G which are relevant for Wess-Zumino-Witten models. We classify thereby all Wess-Zumino-Witten models on compact simple Lie groups.

5.1 Twisted equivariant Structures on Bundle Gerbes

The natural way to introduce a notion of an equivariant structure on a bundle gerbe is the categorification of an equivariant structure on a line bundle. If Γ is a discrete group acting smoothly on the left on M , and L is a line bundle over M , a Γ -equivariant structure relates the pullbacks x^*L of the line bundle L along the smooth map $x : M \rightarrow M$ associated to any group element $x \in \Gamma$, to the line bundle L itself. Notice that there is a subtlety concerning left and

right actions: since for all group elements $x, y \in \Gamma$ the associated maps satisfy $x \circ y = xy$, the pullback x^* – regarded as an endofunctor of $\mathfrak{Lin}(M)$ – has the property $x^*y^* = (yx)^*$, so that it gives a *right* action on line bundles. It will be convenient to circumvent this by introducing a new pullback functor $x^\star := (x^{-1})^*$, which now satisfies

$$x^\star y^\star = (x^{-1})^*(y^{-1})^* = (y^{-1} \circ x^{-1})^* = (x \circ y)^\star = (xy)^\star.$$

With this modified pullback, a Γ -equivariant structure on a line bundle L over M is a family $\{\varphi_x\}_{x \in \Gamma}$ of isomorphisms $\varphi_x : L \rightarrow x^\star L$ satisfying $x^\star \varphi_y \circ \varphi_x = \varphi_{xy}$. The natural categorification of this structure to bundle gerbes would be to replace the isomorphisms φ_x by 1-isomorphisms

$$\mathcal{A}_x : \mathcal{G} \rightarrow x^\star \mathcal{G},$$

and the equalities by 2-isomorphisms

$$\varphi_{x,y} : x^\star \mathcal{A}_y \circ \mathcal{A}_x \Rightarrow \mathcal{A}_{xy},$$

and to pose a coherence condition on these 2-isomorphisms.

Before we fix this as the final definition, we modify the pullback once more for further purposes. This is because we want to regard a Jandl structure on a bundle gerbe \mathcal{G} as a particular example of an equivariant structure, namely for the group $\Gamma = \mathbb{Z}_2$. However, a Jandl structure relates the pullback $x^\star \mathcal{G}$ to the *dual* bundle gerbe \mathcal{G}^* instead to \mathcal{G} . To incorporate this behaviour we consider a group homomorphism $\epsilon : \Gamma \rightarrow \mathbb{Z}_2 = \{-1, 1\}$ indicating whether a group element $x \in \Gamma$ relates the pullback $x^\star \mathcal{G}$ to \mathcal{G} (for $\epsilon(x) = 1$) or to \mathcal{G}^* (for $\epsilon(x) = -1$). We have to implement this properly in terms of 2-functors

$$x^\circledast : \mathfrak{BGrb}(M) \rightarrow \mathfrak{BGrb}(M)$$

associated to every group element $x \in \Gamma$. We set

$$x^\circledast := x^\star \quad \text{for } \epsilon(x) = 1.$$

For the elements with $\epsilon(x) = -1$, consider the strict 2-functor

$$()^\dagger : \mathfrak{BGrb}(M) \rightarrow \mathfrak{BGrb}(M)$$

which combines the duality 2-functor $()^*$ from §2.5 and the functor $()^{-1}$ on isomorphism categories from §2.3 as follows

- 1) for a bundle gerbe \mathcal{G} , we set $\mathcal{G}^\dagger := \mathcal{G}^*$.
- 2) for a 1-isomorphism $\mathcal{A} : \mathcal{G} \rightarrow \mathcal{H}$ we set $\mathcal{A}^\dagger := \mathcal{A}^{*-1}$; this is a 1-isomorphism

$$\mathcal{A}^\dagger : \mathcal{G}^\dagger \rightarrow \mathcal{H}^\dagger.$$

- 3) for a 2-isomorphism $\beta : \mathcal{A} \Rightarrow \mathcal{A}'$ we set $\beta^\dagger := \beta^{*\#-1}$; this gives a 2-isomorphism

$$\beta^\dagger : \mathcal{A}^\dagger \Rightarrow \mathcal{A}'^\dagger.$$

Actually this 2-functor is only defined on a sub-2-groupoid of $\mathfrak{BGrb}(M)$, whose morphism categories are $\mathfrak{Iso}(\mathcal{G}, \mathcal{H})$ instead of $\mathfrak{Hom}(\mathcal{G}, \mathcal{H})$, but this will be unessential in the sequel. Anyway, the 2-functor $(\)^\dagger$ is strictly involutive:

$$\mathcal{G}^{\dagger\dagger} = \mathcal{G} \quad , \quad \mathcal{A}^{\dagger\dagger} = \mathcal{A} \quad \text{and} \quad \beta^{\dagger\dagger} = \beta.$$

Now we define the 2-functors x^\otimes by

$$x^\otimes := (\)^\dagger \circ x^* \quad \text{for } \epsilon(x) = -1.$$

Finally, the modified pullback 2-functors satisfy

$$x^\otimes \circ y^\otimes = (xy)^\otimes,$$

for all $x, y \in \Gamma$. This follows from the involutive property of $(\)^\dagger$ and from the fact that it commutes with the pullbacks x^* , as proved in §2.5.

Definition 5.1.1. *Let Γ be a finite group acting smoothly on the left on a smooth manifold M , let $\epsilon : \Gamma \rightarrow \mathbb{Z}_2$ be a group homomorphism and let x^\otimes denote the 2-functor associated to a group element $x \in \Gamma$ depending on $\epsilon(x)$ as described above. A twisted equivariant structure or Γ^ϵ -equivariant structure on a bundle gerbe \mathcal{G} over M is a family $\{\mathcal{A}_x\}_{x \in \Gamma}$ of isomorphisms*

$$\mathcal{A}_x : \mathcal{G} \rightarrow x^\otimes \mathcal{G}$$

together with a family $\{\varphi_{x,y}\}_{x,y \in \Gamma}$ of 2-isomorphisms

$$\varphi_{x,y} : x^\otimes \mathcal{A}_y \circ \mathcal{A}_x \Rightarrow \mathcal{A}_{xy}$$

such that the diagram

$$\begin{array}{ccc} x^\otimes y^\otimes \mathcal{A}_z \circ x^\otimes \mathcal{A}_y \circ \mathcal{A}_x & \xrightarrow{\text{id} \circ \varphi_{x,y}} & x^\otimes y^\otimes \mathcal{A}_z \circ \mathcal{A}_{xy} \\ \Downarrow x^\otimes \varphi_{y,z} \circ \text{id} & & \Downarrow \varphi_{xy,z} \\ x^\otimes \mathcal{A}_{yz} \circ \mathcal{A}_x & \xrightarrow{\varphi_{x,yz}} & \mathcal{A}_{xyz} \end{array}$$

of 2-isomorphisms is commutative.

We call a Γ^ϵ -equivariant structure on a bundle gerbe \mathcal{G} *normalized*, if the following choices concerning the neutral group element $1 \in \Gamma$ are present:

- (a) the 1-isomorphism $\mathcal{A}_1 : \mathcal{G} \rightarrow \mathcal{G}$ is the identity 1-isomorphism $\text{id}_{\mathcal{G}}$.
- (b) the 2-isomorphism $\varphi_{1,x} : \mathcal{A}_x \circ \text{id}_{\mathcal{G}} \Rightarrow \mathcal{A}_x$ is the natural 2-isomorphism $\lambda_{\mathcal{A}_x}$ from the 2-category of bundle gerbes.
- (c) accordingly, the 2-isomorphism $\varphi_{x,1} : \text{id}_{x^\otimes \mathcal{G}} \circ \mathcal{A}_x \Rightarrow \mathcal{A}_x$ is the natural 2-isomorphism $\rho_{\mathcal{A}_x}$ from the 2-category of bundle gerbes.

Note that the 2-isomorphism $\varphi_{1,1} : \text{id}_{\mathcal{G}} \circ \text{id}_{\mathcal{G}} \Rightarrow \text{id}_{\mathcal{G}}$ is then equal to both $\lambda_{\text{id}_{\mathcal{G}}}$ and $\rho_{\text{id}_{\mathcal{G}}}$, whose equality follows from Proposition 2.3.2. We will in the following for simplicity assume that all Γ^ϵ -equivariant structures are normalized.

Definition 5.1.2. *Let \mathcal{G} be a bundle gerbe over M , and let*

$$\mathcal{J} = (\{\mathcal{A}_x\}_{x \in \Gamma}, \{\varphi_{x,y}\}_{x,y \in \Gamma}) \quad \text{and} \quad \mathcal{J}' = (\{\mathcal{A}'_x\}_{x \in \Gamma}, \{\varphi'_{x,y}\}_{x,y \in \Gamma})$$

be Γ^ϵ -equivariant structures on \mathcal{G} . A morphism of Γ^ϵ -equivariant structures

$$\beta : \mathcal{J} \Rightarrow \mathcal{J}'$$

is a collection $\{\beta_x\}_{x \in \Gamma}$ of 2-morphisms $\beta_x : \mathcal{A}_x \Rightarrow \mathcal{A}'_x$, such that the diagram

$$\begin{array}{ccc} x^\otimes \mathcal{A}_y \circ \mathcal{A}_x & \xrightarrow{\varphi_{x,y}} & \mathcal{A}_{xy} \\ \downarrow x^\otimes \beta_y \circ \beta_x & & \downarrow \beta_{xy} \\ x^\otimes \mathcal{A}'_y \circ \mathcal{A}'_x & \xrightarrow{\varphi'_{x,y}} & \mathcal{A}'_{xy} \end{array}$$

of 2-morphisms is commutative.

According to the normalization condition on twisted equivariant structures, we say that a morphism of normalized twisted equivariant structures is normalized if $\beta_1 = \text{id}_{\text{id}_{\mathcal{G}}}$. We assume for the sequel that all morphisms of twisted equivariant structures are normalized.

The composition of such morphisms is obviously associative, and there exist identity morphisms, so that we can speak of a category $\mathfrak{Eq}(\Gamma^\epsilon, \mathcal{G})$ of Γ^ϵ -equivariant structures on the bundle gerbe \mathcal{G} . Since any 2-morphism between 1-isomorphisms is invertible, this is moreover a groupoid. We will see in §5.5 that this groupoid generalizes the groupoid $\mathfrak{Jdl}(k, \mathcal{G})$ of Jandl structures on \mathcal{G} . With this hint, the following Proposition generalizes Proposition 4.2.5 for Jandl structures.

Proposition 5.1.3. *A 1-isomorphism $\mathcal{B} : \mathcal{G} \rightarrow \mathcal{G}'$ between bundle gerbes \mathcal{G} and \mathcal{G}' over M induces an equivalence of groupoids*

$$J_{\mathcal{B}} : \mathfrak{Eq}(\Gamma^\epsilon, \mathcal{G}') \rightarrow \mathfrak{Eq}(\Gamma^\epsilon, \mathcal{G})$$

which is compatible with the composition of 1-isomorphisms in the sense that

$$J_{\mathcal{B}' \circ \mathcal{B}} = J_{\mathcal{B}} \circ J_{\mathcal{B}'} \quad \text{and} \quad J_{\text{id}_{\mathcal{G}}} \cong \text{id}_{\mathfrak{Eq}(\Gamma^\epsilon, \mathcal{G})}.$$

Proof. Using the 2-categorical language, the proof is rather the same as the one of Proposition 4.2.5. If \mathcal{J} is a Γ^ϵ -equivariant structure on \mathcal{G}' , consisting of 1-isomorphisms \mathcal{A}'_x and 2-isomorphisms $\varphi'_{x,y}$, we define the Γ^ϵ -equivariant structure on \mathcal{G} by the 1-isomorphisms

$$\mathcal{A}_x := x^{\otimes} \mathcal{B}^{-1} \circ \mathcal{A}'_x \circ \mathcal{B}$$

and the 2-isomorphisms $\varphi_{x,y}$ given by

$$\begin{array}{c} x^{\otimes} \mathcal{A}_y \circ \mathcal{A}_x = x^{\otimes} y^{\otimes} \mathcal{B}^{-1} \circ x^{\otimes} \mathcal{A}'_y \circ x^{\otimes} \mathcal{B} \circ x^{\otimes} \mathcal{B}^{-1} \circ \mathcal{A}'_x \circ \mathcal{B} \\ \Downarrow \text{id} \circ i_r^{-1} \circ \text{id} \\ x^{\otimes} y^{\otimes} \mathcal{B}^{-1} \circ x^{\otimes} \mathcal{A}'_y \circ \mathcal{A}'_x \circ \mathcal{B} \\ \Downarrow \text{id} \circ \varphi_{x,y} \circ \text{id} \\ (xy)^{\otimes} \mathcal{B}^{-1} \circ \mathcal{A}'_{xy} \circ \mathcal{B} = \mathcal{A}'_{xy} \end{array}$$

The diagram for $\varphi_{\gamma_1, \gamma_2}$ from Definition 5.1.1 is commutative, and the claimed compatibility with the composition of 1-isomorphisms follows directly from the definition. \blacksquare

It will be useful to exhibit explicitly the details of a Γ^ϵ -equivariant structure \mathcal{J} on a bundle gerbe \mathcal{G} . We call a Γ^ϵ -equivariant Jandl structure *descended*, if the 1-isomorphisms \mathcal{A}_x are objects in the subcategory $\mathfrak{Hom}_{FP}(\mathcal{G}, x^{\otimes} \mathcal{G})$, see §2.4, and if the 2-isomorphisms $\varphi_{x,y}$ can be represented by triples $(W_{x,y}, \omega_{x,y}, \varphi_{x,y})$ whose surjective submersion $\omega_{x,y}$ is the identity.

Lemma 5.1.4. *Let \mathcal{G} be a bundle gerbe over M with Γ^ϵ -equivariant structure \mathcal{J} . Then there exists an isomorphic descended Γ^ϵ -equivariant structure \mathcal{J}' .*

Proof. Let \mathcal{J} consist of 1-isomorphisms \mathcal{A}_x and 2-isomorphisms $\varphi_{x,y}$. Using the equivalence $D : \mathfrak{Hom}_{FP}(\mathcal{G}, x^{\otimes} \mathcal{G}) \rightarrow \mathfrak{Hom}(\mathcal{G}, x^{\otimes} \mathcal{G})$ from Theorem 2.4.1, and a choice of an inverse functor D^{-1} , we obtain 1-isomorphisms $\mathcal{A}'_x := D^{-1}(\mathcal{A}_x)$ together with 2-isomorphisms $\beta_x : \mathcal{A}_x \Rightarrow \mathcal{A}'_x$. Then we use the functor D again, now for the category $\mathfrak{Hom}(\mathcal{G}, (xy)^{\otimes} \mathcal{G})$ and obtain 2-isomorphisms $\varphi'_{x,y} : D^{-1}(x^{\otimes} \mathcal{A}_y \circ \mathcal{A}_x) \Rightarrow \mathcal{A}'_{xy}$. Now, $\varphi'_{x,y}$ and β_x commute in the sense of the commutative diagram in Definition 5.1.2, since D^{-1} is an equivalence of categories. Finally, since $D^{-1}(x^{\otimes} \mathcal{A}_y \circ \mathcal{A}_x) \cong D^{-1}(x^{\otimes} \mathcal{A}'_y \circ \mathcal{A}'_x)$, we can pullback $\varphi'_{x,y}$ to a 2-isomorphism $\varphi''_{x,y} : x^{\otimes} \mathcal{A}'_y \circ \mathcal{A}'_x \Rightarrow \mathcal{A}'_{xy}$. By functoriality, these 2-isomorphisms make the diagram from Definition 5.1.1 commutative. \blacksquare

We can now assume without loss of generality, that a Γ^ϵ -equivariant structure \mathcal{J} on \mathcal{G} is descended. If the bundle gerbe \mathcal{G} has – following our standard conventions – the surjective submersion $\pi : Y \rightarrow M$, the bundle gerbe $x^* \mathcal{G}$ has the surjective submersion $\pi_x : Y_x \rightarrow M$ with $Y_x := Y$ and $\pi_x := x \circ \pi$, so that the diagram

$$\begin{array}{ccc}
 Y_x & \xlongequal{\quad} & Y \\
 \pi_x \downarrow & & \downarrow \pi \\
 M & \xrightarrow{x^{-1}} & M
 \end{array}$$

is commutative. The 1-isomorphism $\mathcal{A}_x : \mathcal{G} \rightarrow x^{\otimes} \mathcal{G}$ consists of a line bundle A_x over $Z_x := Y \times_M Y_x$ and a certain isomorphism α_x of line bundles over $Z_x \times_M Z_x$. We denote the projection from Z_x to M by $\zeta_x : Z_x \rightarrow M$, and the projections to the factors by $\pi_1 : Z_x \rightarrow Y$ and $\pi_2 : Z_x \rightarrow Y_x$; both are morphisms of surjective submersions. Note that axiom (1M1) for \mathcal{A}_x gives

$$\text{curv}(A_x) = \epsilon(x)\pi_2^* C - \pi_1^* C.$$

To discuss the 2-isomorphism $\varphi_{x,y}$, we first look at the pullback 1-isomorphism $x^{\otimes} \mathcal{A}_y$. For the pullback of the surjective submersion $\zeta_y : Z_y \rightarrow M$ along x^{-1} we set $Z_y^x := Z_y$ with the surjective submersion $\zeta_y^x := x \circ \zeta_y$, yielding the commutative diagram

$$\begin{array}{ccc}
 Z_y^x & \xlongequal{\quad} & Z_y \\
 \zeta_y^x \downarrow & & \downarrow \zeta_y \\
 M & \xrightarrow{x^{-1}} & M.
 \end{array}$$

Now we make use of the simple definition of the composition of 1-morphisms introduced in Chapter 2. Accordingly, for the 1-isomorphism $x^{\otimes} \mathcal{A}_y \circ \mathcal{A}_x$ we have to consider the fibre product

$$Z_{x,y} := Z_x \times_{Y_x} Z_y^x = Y \times_M Y_x \times_M Y_{xy}$$

whose projections to the factors we denote by $\pi_{12} : Z_{x,y} \rightarrow Z_x$, $\pi_{23} : Z_{x,y} \rightarrow Z_y^x$ and $\pi_{13} : Z_{x,y} \rightarrow Z_{xy}$. Notice that for $\epsilon(x) = -1$, the line bundle of the 1-isomorphism $x^{\otimes} \mathcal{A}_y = x^* \mathcal{A}_y^\dagger = x^* \mathcal{A}_y^{*-1}$ is dualized, what we indicate by $A_y^{\epsilon(x)}$. So, the composed 1-isomorphisms provides the line bundle $\pi_{12}^* A_x \otimes \pi_{23}^* A_y^{\epsilon(x)}$ over the fibre product $Z_{x,y}$. Since \mathcal{J} was assumed to be descended, we may represent the 2-isomorphism $\varphi_{x,y}$ by a triple $(W_{x,y}, \omega_{x,y}, \varphi_{x,y})$ with $W_{x,y} := Z_{x,y}$, $\omega_{x,y} := \text{id}$, and an isomorphism

$$\varphi_{x,y} : \pi_{12}^* A_x \otimes \pi_{23}^* A_y^{\epsilon(x)} \rightarrow \pi_{13}^* A_{xy}$$

of line bundles over $Z_{x,y}$. Finally, the commutative diagram from Definition 5.1.1 for the 1-isomorphisms $\varphi_{x,y}$ gives a commutative diagram for isomorphisms of line bundles over the fibre product

$$Z_{x,y,z} := Y \times_M Y_x \times_M Y_{xy} \times_M Y_{xyz}, \quad (5-1)$$

namely

$$\begin{array}{ccc}
 \pi_{12}^* A_x \otimes \pi_{23}^* A_y^{\epsilon(x)} \otimes \pi_{34}^* A_z^{\epsilon(xy)} & \xrightarrow{\pi_{123}^* \varphi_{x,y} \otimes \text{id}} & \pi_{13}^* A_{xy} \otimes \pi_{34}^* A_z^{\epsilon(xy)} \\
 \text{id} \otimes \pi_{234}^* \varphi_{y,z}^{\epsilon(x)} \downarrow & & \downarrow \pi_{134}^* \varphi_{xy,z} \\
 \pi_{12}^* A_x \otimes \pi_{24}^* A_{yz}^{\epsilon(x)} & \xrightarrow{\pi_{124}^* \varphi_{x,yz}} & \pi_{14}^* A_{xyz}.
 \end{array} \quad (5-2)$$

Let us summarize all these results in the following

Lemma 5.1.5. *A descended Γ^ϵ -equivariant structure \mathcal{J} on a bundle gerbe \mathcal{G} defines*

(a) *for each $x \in \Gamma$ a line bundle A_x over Z_x of curvature*

$$\text{curv}(A_x) = \epsilon(x) \pi_2^* C - \pi_1^* C,$$

(b) *and for each pair $x, y \in \Gamma$ an isomorphism*

$$\varphi_{x,y} : \pi_{12}^* A_x \otimes \pi_{23}^* A_y^{\epsilon(x)} \rightarrow \pi_{13}^* A_{xy}$$

of line bundles over $Z_{x,y}$ which are associative in the sense that diagram (5-2) is commutative.

The normalization condition on Γ^ϵ -equivariant structures infers here that A_1 over $Z_1 = Y^{[2]}$ is the line bundle L of \mathcal{G} , that $\varphi_{1,x}$ and $\varphi_{x,1}$ are the isomorphisms λ_W and ρ_W from §2.3, and that the isomorphism $\varphi_{1,1}$ of line bundles over $Z_{1,1} = Y^{[3]}$ is just the multiplication μ of \mathcal{G} .

A bundle gerbe \mathcal{G} over M with Γ^ϵ -equivariant structure is now called *twisted equivariant bundle gerbe*, or more precisely, *Γ^ϵ -equivariant bundle gerbe*. Combining Definition 5.1.2 with Proposition 5.1.3 we obtain a notion of equivalence between Γ^ϵ -equivariant bundle gerbes.

Definition 5.1.6. *Two Γ^ϵ -equivariant bundle gerbes $(\mathcal{G}, \mathcal{J})$ and $(\mathcal{G}', \mathcal{J}')$ are considered to be equivalent, if there exists a 1-isomorphism*

$$\mathcal{B} : \mathcal{G} \rightarrow \mathcal{G}'$$

of bundle gerbes over M and a morphism

$$\beta : J_{\mathcal{B}}(\mathcal{J}') \Rightarrow \mathcal{J}$$

of Γ^ϵ -equivariant structures on \mathcal{G} .

In the next section, we derive a cohomological classification of the set of equivalence classes of Γ^ϵ -equivariant bundle gerbes over a smooth manifold M . Equipped with this classification, we are ready to discuss the descent theory of bundle gerbes and Jandl structures in the following sections §5.4 and §5.5.

5.2 Twisted equivariant Deligne Cohomology

The setup to describe equivalence classes of equivariant bundle gerbes over a smooth manifold M by Deligne cohomology will again be a finite group Γ acting smoothly on the left on M , and a group homomorphism $\epsilon : \Gamma \rightarrow \mathbb{Z}_2$. In this section, we incorporate this group action in the Deligne cohomology groups.

We recall from §1.3 that Deligne cohomology is the hypercohomology of a sheaf complex $\mathcal{D}^\bullet(n)$, which we have calculated in the following way: we considered the double complex $\check{C}^p(\mathfrak{V}, \mathcal{D}^q(n))$ consisting of the Čech cochain groups with respect to an open cover \mathfrak{V} and with values in the sheaves $\mathcal{D}^q(n)$, and have formed its total complex $\text{Tot}^n(\mathfrak{V}, \mathcal{D}(n))$. The cohomology $\check{H}^\bullet(\mathfrak{V}, \mathcal{D}(n))$ of this total complex forms an inductive system, whose limit can be identified with the hypercohomology $H^\bullet(M, \mathcal{D}(n))$, the Deligne cohomology in degree n . Let us start the modification of the Deligne sheaf complex $\mathcal{D}^\bullet(n)$ by incorporating the group action of Γ . As before, we denote the diffeomorphism associated to a group element $x \in \Gamma$ by $x : M \rightarrow M$; furthermore, we denote the pushforward of a sheaf \mathcal{F} over M along a map $f : M \rightarrow N$ by $f_*\mathcal{F}$; this sheaf assigns to an open subset U of N the set $\mathcal{F}(f^{-1}(U))$. We use the following notion of an equivariant sheaf.

Definition 5.2.1. *Let Γ be a finite group acting smoothly on the left on a smooth manifold M , and let \mathcal{F} be a sheaf over M . A Γ -equivariant structure on \mathcal{F} is a family of sheaf homomorphisms*

$$\phi_x : \mathcal{F} \rightarrow x_*^{-1}\mathcal{F},$$

one for each group element $x \in \Gamma$, such that

$$\phi_1 = \text{id}_{\mathcal{F}} \quad \text{and} \quad x_*^{-1}\phi_y \circ \phi_x = \phi_{xy}.$$

A sheaf with Γ -equivariant structure is called Γ -equivariant sheaf.

In our case the relevant sheaves are $\mathcal{D}^0(n) = \underline{\mathbf{U}(1)}_M$ and $\mathcal{D}^q(n) = \underline{\Omega}^q_M$, on which we now define Γ -equivariant structures. The sheaf homomorphisms ϕ_x are defined over an open subset V of M as follows. For $t \in C^\infty(V, \mathbf{U}(1))$, we set

$$\phi_x(t) := (x^{-1})^*t^{\epsilon(x)} \in C^\infty(x(V), \mathbf{U}(1)),$$

and for $W \in \Omega^q(V)$, we set

$$\phi_x(W) := \epsilon(x)(x^{-1})^*W \in \Omega^q(x(V)).$$

This way we imitate the action of Γ on the 2-category $\mathfrak{BGrb}(M)$ by the functors x^\otimes .

A key ingredient for the description of Γ^ϵ -equivariant bundle gerbes is the observation that group cohomology is relevant. The proper way to deal with this would be to introduce group cohomology with values in equivariant sheaves, but this is beyond the scope of this thesis. So we decide at this point to continue using Čech cohomology, similarly to §1.3.

Lemma 5.2.2. *Let \mathcal{F} be a Γ -equivariant sheaf of abelian groups over M , and let $\mathfrak{V} = \{V_i\}_{i \in I}$ be an open cover of M together with a left action of Γ on the index set I , such that $x(V_i) = V_{x_i}$. Then, the Čech cochain groups $\check{C}^p(\mathfrak{V}, \mathcal{F})$ and the Čech cohomology groups $\check{H}^p(M, \mathcal{F})$ are left Γ -modules, and the projection*

$$\ker \delta|_{\check{C}^p(\mathfrak{V}, \mathcal{F})} \rightarrow \check{H}^p(M, \mathcal{F})$$

to cohomology classes is a homomorphism of Γ -modules.

Proof. Notice that for any $x \in \Gamma$ there is a canonical group isomorphism

$$\check{C}^p(\mathfrak{V}, \mathcal{F}) \cong \check{C}^p(\mathfrak{V}, x_*^{-1}\mathcal{F})$$

which just resorts direct summands. Under this identification, the sheaf homomorphisms ϕ_x of the Γ -equivariant sheaf \mathcal{F} induce group homomorphisms

$$x := (\phi_x)_* : \check{C}^p(\mathfrak{V}, \mathcal{F}) \rightarrow \check{C}^p(\mathfrak{V}, \mathcal{F}),$$

and the conditions on the ϕ_x infer that these group homomorphisms put a left module structure on $\check{C}^p(\mathfrak{V}, \mathcal{F})$. In the same way, we obtain induced group homomorphisms in Čech cohomology. ■

We assume that open covers \mathfrak{V} with the invariance property from Lemma 5.2.2 always exist, and assume furthermore that these covers can even be chosen to be good. It will be convenient to consider the total complex $\text{Tot}^\bullet(\mathfrak{V}, \mathcal{D}(n))$, defined as a direct sum of the left Γ -modules $\check{C}^p(\mathfrak{V}, \mathcal{D}^q(n))$, itself as a left Γ -module. The differential

$$D : \text{Tot}^k(\mathfrak{V}, \mathcal{D}(n)) \rightarrow \text{Tot}^{k+1}(\mathfrak{V}, \mathcal{D}(n))$$

of this total complex, composed in §1.3 from the exterior derivative d and the Čech coboundary operator δ , is then a homomorphism of Γ -modules. Note that the Γ -module structures imposed by Lemma 5.2.2 on the cohomology groups $H^k(M, \mathbb{U}(1))$ and $H^k(M, \mathcal{D}(n))$ are (in the additive notation) just given by

$$x\alpha := \epsilon(x)(x^{-1})^*\alpha$$

for any cohomology class α .

In general, for any left Γ -module A , the group cohomology of A is the cohomology of a complex composed of cochain groups $C_\Gamma^k(A) := \text{Map}(\Gamma^k, A)$. We denote the value of a map $n \in C_\Gamma^k(A)$ at $x_1, \dots, x_k \in \Gamma$ by $n_{x_1, \dots, x_k} \in A$. The coboundary operator is the group homomorphism

$$\Delta : C_\Gamma^k(A) \rightarrow C_\Gamma^{k+1}(A)$$

defined by

$$\begin{aligned}
(\Delta n)_{x_1, \dots, x_{k+1}} &:= x_1 n_{x_2, \dots, x_{k+1}} - n_{x_1 x_2, \dots, x_{k+1}} + \dots \\
&\quad + (-1)^k n_{x_1, \dots, x_k x_{k+1}} + (-1)^{k+1} n_{x_1, \dots, x_k}.
\end{aligned}$$

By standard arguments $\Delta^2 = 0$. More general, if A^\bullet is a complex of Γ -modules, we obtain a double complex $C_\Gamma^k(A^l)$.

We apply this general setup to the complex $A^\bullet := \text{Tot}^\bullet(\mathfrak{Y}, \mathcal{D}(n))$ of Γ -modules, and denote the total complex of the associated double complex by

$$\text{Tot}_\Gamma^p(\mathfrak{Y}, \mathcal{D}(n)) := \bigoplus_{p=k+l} C_\Gamma^k(A^l) = \bigoplus_{p=k+l} C_\Gamma^k(\text{Tot}^l(\mathfrak{Y}, \mathcal{D}(n))).$$

Its differential is

$$D_\Gamma|_{C_\Gamma^k(A^l)} := \Delta + (-1)^{k+1} D.$$

The cohomology of the complex $\text{Tot}_\Gamma^p(\mathfrak{Y}, \mathcal{D}(n))$ with the differential D_Γ is denoted by $\check{H}_\Gamma^\bullet(\mathfrak{Y}, \mathcal{D}(n))$. The groups $\check{H}_\Gamma^\bullet(\mathfrak{Y}, \mathcal{D}(n))$ form a directed system over the directed set of open covers of M , whose direct limit we denote by

$$H_\Gamma^p(M, \mathcal{D}(n)) := \lim_{\overrightarrow{\mathfrak{A}}} \check{H}_\Gamma^p(\mathfrak{Y}, \mathcal{D}(n)).$$

We call this cohomology the *twisted equivariant Deligne cohomology* or Γ^ϵ -equivariant Deligne cohomology, and will also use the notation $H_{\Gamma, \epsilon}^p(M, \mathcal{D}(n))$ to emphasize that the action of Γ is not only induced by an action of Γ on M but also modified by ϵ . It is to expect that these cohomology groups can also be obtained as the hypercohomology of a sheaf double complex, coming from the group cohomology complex with values in the complex $\mathcal{D}^\bullet(n)$ of Γ -equivariant sheaves. Another way to define equivariant Deligne cohomology that also applies to topological group actions is by simplicial sheaves [Gom03, LU01].

Now we are going to relate the Γ^ϵ -equivariant Deligne cohomology we just have defined to Γ^ϵ -equivariant bundle gerbes. For this purpose, let us begin with extracting local data from a Γ^ϵ -equivariant bundle gerbe $(\mathcal{G}, \mathcal{J})$ with respect to a good open cover \mathfrak{Y} of M satisfying the assumption of Lemma 5.2.2. First of all, let $\xi \in \text{Tot}^2(\mathfrak{Y}, \mathcal{D}(2))$ be a cocycle for the bundle gerbe \mathcal{G} . Then, for any $x \in \Gamma$, let $\beta_x \in \text{Tot}^1(\mathfrak{Y}, \mathcal{D}(2))$ be a cochain for the 1-isomorphism $\mathcal{A}_x : \mathcal{G} \rightarrow x^\otimes \mathcal{G}$ of the Γ^ϵ -equivariant structure, i.e.

$$x\xi = \xi + D\beta_x. \quad (5-3)$$

Here, $x\xi$ is the image of ξ under the action of $x \in \Gamma$ using the Γ -module structure we have on $\text{Tot}^\bullet(\mathfrak{Y}, \mathcal{D}(2))$. Then, according to the discussion in §2.6 the 1-isomorphism $x^\otimes \mathcal{A}_y \circ \mathcal{A}_x$ has the cochain $xb_y + b_x$. If now $\alpha_{x,y} \in \text{Tot}^0(\mathfrak{Y}, \mathcal{D}(2))$ is a cochain for the 2-isomorphism $\varphi_{x,y}$, i.e.

$$\beta_{xy} = x\beta_y + \beta_x + D\alpha_{x,y}, \quad (5-4)$$

the commuting diagram from Definition 5.1.1 becomes

$$x\alpha_{y,z} + \alpha_{x,yz} = \alpha_{xy,z} + \alpha_{x,y}. \quad (5-5)$$

So, the Γ -module structure on the total complex $\text{Tot}^k(\mathfrak{A}, \mathcal{D}(n))$ we have defined fits conveniently to equivariant structures. Next we recognize that the cochains ξ , β_x , and $\alpha_{x,y}$ give rise to elements in the double complex $C_\Gamma^k(A^l)$, namely $\xi \in C_\Gamma^0(A^2)$, $\beta \in C_\Gamma^1(A^1)$ and $\alpha \in C_\Gamma^2(A^0)$. Notice that the normalization condition we imposed for twisted equivariant structures gives rise to cochains $\alpha \in C_\Gamma^2(A^0)$ and $\beta \in C_\Gamma^1(A^1)$ which are normalized in the sense used in group cohomology: $\alpha_{x,y} = 1$ if either $x = 1$ or $y = 1$ and $\beta_1 = 0$.

Using the coboundary operator Δ one can rewrite the three equations (5-3) to (5-5) as

$$(\Delta\xi)_x = D\beta_x \quad , \quad (\Delta\beta)_{x,y} = -D\alpha_{x,y} \quad \text{and} \quad (\Delta\alpha)_{x,y,z} = 0. \quad (5-6)$$

Now it is not far to recognize that the triple (α, β, ξ) is a cochain in the total complex $\text{Tot}_\Gamma^2(\mathfrak{A}, \mathcal{D}(n))$, and the equations (5-6), together with the cocycle condition $D\xi = 0$ give the cocycle condition

$$D_\Gamma(\alpha, \beta, \xi) = 0.$$

This way, we have assigned a cohomology class in $H_{\Gamma,\epsilon}^2(M, \mathcal{D}(2))$ to any Γ^ϵ -equivariant bundle gerbe over M .

Lemma 5.2.3. *The cohomology class $[(\alpha, \beta, \xi)] \in H_{\Gamma,\epsilon}^2(M, \mathcal{D}(2))$ of a Γ^ϵ -equivariant bundle gerbe depends neither on the choice of the cochains nor on the equivalence class of the Γ^ϵ -equivariant bundle gerbe.*

Proof. Let ξ' be another cocycle for the bundle gerbe \mathcal{G} , i.e. there exists a cochain $\lambda \in \text{Tot}^1(\mathfrak{A}, \mathcal{D}(2))$ with $\xi' = \xi + D(\lambda)$. With this new choice, the cochains β_x become $\tilde{\beta}_x := \beta_x + (\Delta\lambda)_x$. If β'_x is another choice, there exists a cochain $\kappa \in C_\Gamma^1(\text{Tot}^0(\mathfrak{A}, \mathcal{D}(2)))$ with

$$\beta'_x = \tilde{\beta}_x + D\kappa_x = \beta_x + (\Delta\lambda)_x + D\kappa_x.$$

With this new choice, the cochains $\alpha_{x,y}$ become $\alpha'_{x,y} := \alpha_{x,y} + (\Delta\kappa)_{x,y}$. Summarizing,

$$(\alpha', \beta', \xi') = (\alpha, \beta, \xi) + D_\Gamma(\kappa, \lambda).$$

In the same way, equivalent Γ^ϵ -equivariant bundle gerbes define equivalent cocycles: the isomorphism $\mathcal{B} : \mathcal{G} \rightarrow \mathcal{G}'$ defines the cochain λ , and the morphism φ of Γ^ϵ -equivariant structures defines the cochain κ . \blacksquare

It is convenient to notice that the monoidal structure on the 2-category $\mathfrak{BGrb}(M)$ of bundle gerbes induces a tensor product on Γ^ϵ -equivariant bundle gerbes. The trivial bundle gerbe \mathcal{I}_0 together with a trivial Γ^ϵ -equivariant

structure \mathcal{J}_0 defined by identity 1-isomorphisms $\mathcal{A}_x = \text{id}_{\mathcal{I}_0}$ and identity 2-isomorphisms $\varphi_{x,y} = \text{id}_{\text{id}_{\mathcal{I}_0}}$ is a tensor unit for this tensor product. This way, equivalence classes of Γ^ϵ -equivariant bundle gerbes form a monoid. It is also clear that the cohomology class of a tensor product $(\mathcal{G} \otimes \mathcal{G}', \mathcal{J} \otimes \mathcal{J}')$ is the sum of the classes of the Γ^ϵ -equivariant bundle gerbes $(\mathcal{G}, \mathcal{J})$ and $(\mathcal{G}', \mathcal{J}')$.

Theorem 5.2.4. *The assignment of a cohomology class in $H_{\Gamma,\epsilon}^2(M, \mathcal{D}(2))$ to a Γ^ϵ -equivariant bundle gerbe over M defines a group isomorphism*

$$\left\{ \begin{array}{l} \text{Equivalence classes} \\ \text{of } \Gamma^\epsilon\text{-equivariant} \\ \text{bundle gerbes over } M \end{array} \right\} \xrightarrow{\cong} H_{\Gamma,\epsilon}^2(M, \mathcal{D}(2)).$$

Proof. This is a direct consequence of Proposition 2.6.1. To prove the surjectivity, one uses the 2-functor $\mathcal{C}on$ to construct a Γ^ϵ -equivariant bundle gerbe from a given cocycle in $\text{Tot}_{\Gamma}^2(\mathfrak{V}, \mathcal{D}(2))$. To prove the injectivity assume that the class of a Γ^ϵ -equivariant bundle gerbe $(\mathcal{G}, \mathcal{J})$ vanishes. From any trivializing cochain we reconstruct a 1-isomorphism $\mathcal{B} : \mathcal{I}_0 \rightarrow \mathcal{G}$, and a morphism from the Γ^ϵ -equivariant structure $J_{\mathcal{B}}(\mathcal{J})$ on \mathcal{I}_0 to \mathcal{J}_0 . So we have found an isomorphism of monoids, which shows that the monoid of equivalence classes of Γ^ϵ -equivariant bundle gerbes is even a group. ■

5.3 Obstruction Theory and Classification

In general, there are obstructions against the existence of a Γ^ϵ -equivariant structure on a bundle gerbe \mathcal{G} , and if these vanish, there may be inequivalent choices. We use Theorem 5.2.4 to study these issues in a purely cohomological way. So we are looking for the image and the kernel of the homomorphism

$$\text{pr} : H_{\Gamma,\epsilon}^p(M, \mathcal{D}(n)) \rightarrow H^p(M, \mathcal{D}(2))$$

which sends a twisted equivariant Deligne class to the underlying ordinary Deligne class. We recall that Γ^ϵ -equivariant cohomology is the cohomology of the complex

$$\text{Tot}_{\Gamma}^p(\mathfrak{V}, \mathcal{D}(n)) := \bigoplus_{p=k+l} C_{\Gamma}^k(A^l), \tag{5-7}$$

where we use the abbreviation $A^l := \text{Tot}^l(\mathfrak{V}, \mathcal{D}(n))$ throughout this section. The above homomorphism pr is induced from the projection into the direct summand $C_{\Gamma}^0(A^p) = A^p$, which is indeed a chain map. If we denote by $\text{Tot}_{\Gamma}^p(\mathfrak{V}, \mathcal{D}(n))^1$ the direct sum (5-7) with k restricted to $k \geq 1$, the coboundary operator D_{Γ} restricts to an operator on these cochain groups, so that we have a complex $\text{Tot}_{\Gamma}^{\bullet}(\mathfrak{V}, \mathcal{D}(n))^1$. The cohomology of this complex is, in the direct limit, denoted by $H_{\Gamma,\epsilon}^p(M, \mathcal{D}(n))^1$.

Proposition 5.3.1. *The homomorphism pr from twisted equivariant Deligne cohomology to ordinary Deligne cohomology fits into an exact sequence*

$$0 \longrightarrow \frac{H_{\Gamma,\epsilon}^p(M, \mathcal{D}(n))^1}{H^{p-1}(M, \mathcal{D}(n))} \longrightarrow H_{\Gamma,\epsilon}^p(M, \mathcal{D}(n)) \xrightarrow{\text{pr}} H^p(M, \mathcal{D}(n)) \xrightarrow{\omega} H_{\Gamma,\epsilon}^{p+1}(M, \mathcal{D}(n))^1;$$

in particular, for $n = p = 2$, a bundle gerbe with Deligne cohomology class $\xi \in H^2(M, \mathcal{D}(2))$ admits Γ^ϵ -equivariant structures if and only if the class $\omega(\xi)$ vanishes. In this case, inequivalent choices are parameterized by the quotient $H_{\Gamma,\epsilon}^2(M, \mathcal{D}(2))^1 / (H^1(M, \mathcal{D}(2)))$.

Proof. The exact sequence comes from the long exact sequence induced from the short exact sequence of complexes

$$0 \longrightarrow \text{Tot}_\Gamma^\bullet(\mathfrak{A}, \mathcal{D}(n))^1 \longrightarrow \text{Tot}_\Gamma^\bullet(\mathfrak{A}, \mathcal{D}(n)) \xrightarrow{\text{pr}} \text{Tot}^\bullet(\mathfrak{A}, \mathcal{D}(n)) \longrightarrow 0.$$

Notice that the connecting homomorphism

$$\omega : H^p(M, \mathcal{D}(n)) \rightarrow H_{\Gamma,\epsilon}^{p+1}(M, \mathcal{D}(n))^1$$

sends a representing cocycle $\xi \in A^p$ to the cocycle $(0, \dots, 0, \Delta\xi)$. \blacksquare

Let us first discuss the obstruction class $\omega(\xi) \in H_{\Gamma,\epsilon}^3(M, \mathcal{D}(2))^1$ of a cochain $\xi \in A^2$ for a bundle gerbe \mathcal{G} . Its vanishing $\omega(\xi) = 0$ is equivalent to find cochains $\beta \in C_\Gamma^1(A^1)$ and $\alpha \in C_\Gamma^2(A^0)$ such that $D_\Gamma(\alpha, \beta) = (0, 0, \Delta\xi)$, which are just the equations (5–6), namely

$$\Delta\xi = D\beta \quad , \quad \Delta\beta = -D\alpha \quad \text{and} \quad \Delta\alpha = 0.$$

The first equation is soluble if and only if the Deligne cohomology classes

$$o_{1,x}^{\mathcal{D}}(\xi) := [\Delta\xi_x] \in H^2(M, \mathcal{D}(2))$$

of the cocycles $(\Delta\xi)_x \in A^2$ are trivial for all $x \in \Gamma$. This gives us a family of obstruction classes $\{o_{1,x}^{\mathcal{D}}(\xi)\}_{x \in \Gamma}$. In the case that all these obstruction classes vanish, we may choose a cochain $\beta \in C_\Gamma^1(A^1)$ with $\Delta\xi = D\beta$. The calculation

$$D\Delta\beta = \Delta D\beta = \Delta^2\xi = 0$$

shows that $\tau_{x,y} := (\Delta\beta)_{x,y}$ is a Deligne cocycle and defines a class $[\tau_{x,y}] \in H^1(M, \mathcal{D}(2))$. Since by Lemma 5.2.2 the projection to cohomology classes is a homomorphism of Γ -modules, we have an element $[\tau] \in C_\Gamma^2(H^1(M, \mathcal{D}(2)))$. Since moreover $\Delta[\tau] = 0$, we have found a class

$$o_2^{\mathcal{D}}(\xi) := [[\tau]] \in H_{\Gamma,\epsilon}^2(H^1(M, \mathcal{D}(2))),$$

which is indeed independent of β : for a different choice β' with $\Delta\xi = D\beta'$ and the corresponding cochain $\tau'_{x,y} := (\Delta\beta')_{x,y}$, we have $D(\beta'_x - \beta_x) = 0$, and thus

a cochain $[\beta' - \beta] \in C_{\Gamma}^1(H^1(M, \mathcal{D}(2)))$, whose coboundary is obviously the difference between $[\tau']$ and $[\tau]$.

We claim that the second equation, $\Delta\beta = -D\alpha$, is soluble if and only if the class $o_2^{\mathcal{D}}(\xi)$ is trivial. To see this, notice that if α is a solution, $\tau_{x,y} = (\Delta\beta)_{x,y} = -D\alpha_{x,y}$ so that already the classes $[\tau_{x,y}]$ in Deligne cohomology vanish. Conversely, suppose that $[[\tau]] = 0$. Equivalently, there exist cochains $\chi \in C_{\Gamma}^1(A^1)$ with $D\chi_x = 0$ and $\alpha \in C_{\Gamma}^2(A^0)$ with

$$\tau_{x,y} = (\Delta\chi)_{x,y} - D\alpha_{x,y}.$$

Now we define $\beta' := \beta - \chi$ which still solves the first equation $\Delta\xi = D\beta'$, but also the second one:

$$\Delta\beta'_{x,y} = \tau_{x,y} - (\Delta\chi)_{x,y} = -D\alpha_{x,y}.$$

The calculation $D\Delta\alpha = \Delta D\alpha = \Delta^2\beta'$ shows that $\lambda_{x,y,z} := (\Delta\alpha)_{x,y,z}$ is a Deligne cocycle and defines a class $[\lambda_{x,y,z}] \in H^0(M, \mathcal{D}(2))$, so that we have an element $\lambda \in C_{\Gamma}^3(H^0(M, \mathcal{D}(2)))$. Since $\Delta\lambda = 0$, it represents a class

$$o_3^{\mathcal{D}}(\xi, \beta') := [\lambda] \in H_{\Gamma, \epsilon}^3(H^0(M, \mathcal{D}(2))),$$

which is independent of α : for a different choice α' with $\Delta\beta' = -D\alpha$ it follows that $D(\alpha' - \alpha) = 0$ so that $[\alpha' - \alpha] \in C_{\Gamma}^2(H^0(M, \mathcal{D}(2)))$; its coboundary is the difference between the cocycles λ and λ' .

We claim that the third equation $\Delta\alpha = 0$ is soluble if and only if the class $o_3^{\mathcal{D}}(\xi, \beta')$ vanishes. Any solution of this equation leads to the trivial cocycle $\lambda_{x,y,z} = 0$, so that $[\lambda] = 0$. Conversely, supposed $[\lambda] = 0$, there exists a cochain $\kappa \in C_{\Gamma}^2(A^0)$ with $D\kappa_{x,y} = 0$ and $\lambda = \Delta\kappa$. Now we define $\alpha' := \alpha - \kappa$ so that the second equation is still satisfied, $\Delta\beta' = -D\alpha = -D\alpha'$, but also the third, $\Delta\alpha' = \Delta\alpha - \Delta\kappa = 0$.

All obstruction classes we have extracted from the cocycle ξ of a bundle gerbe \mathcal{G} take values in the Deligne cohomology groups. Before we summarize our results in Theorem 5.3.2 below, we shall express these classes by singular cohomology classes. It will be convenient to split the family $o_{1,x}^{\mathcal{D}}(\xi) \in H^2(M, \mathcal{D}(2))$ of obstruction classes in two parts: we recall the group homomorphism

$$d : H^k(M, \mathcal{D}(k)) \rightarrow \Omega^{k+1}(M)$$

that fits by Proposition 1.3.9 into the exact sequence

$$0 \longrightarrow H^k(M, \mathbf{U}(1)) \xrightarrow{f} H^k(M, \mathcal{D}(k)) \xrightarrow{d} \Omega^{k+1}(M).$$

The 3-form $d([\xi])$ is just the curvature of the bundle gerbe \mathcal{G} . We say that a bundle gerbe \mathcal{G} has Γ^{ϵ} -equivariant curvature, if

$$\text{curv}(x^{\otimes} \mathcal{G}) = \text{curv}(\mathcal{G})$$

for all $x \in \Gamma$. Notice that this is the case if the classes $o_{1,x}^{\mathcal{D}}(\xi)$ vanishes. Conversely, assume that the bundle gerbe \mathcal{G} has Γ^ϵ -equivariant curvature. Then, the classes $o_{1,x}^{\mathcal{D}}(\xi)$ are in the kernel of d , and hence in the image of the injective group homomorphism f . So they define unique classes

$$o_{1,x}(\xi) := f^{-1}o_{1,x}^{\mathcal{D}}(\xi) \in H^2(M, \mathbb{U}(1)).$$

For the remaining obstruction classes recall from Proposition 1.3.9 that the group homomorphism f is for $k < n$ an isomorphism. It is even more an isomorphism of Γ -modules with respect to the Γ -action on cohomology groups induced by Lemma 5.2.2. The induced isomorphism f_* in group cohomology defines the classes

$$o_2(\xi) := f_*^{-1}o_2^{\mathcal{D}}(\xi) \in H_{\Gamma,\epsilon}^2(H^1(M, \mathbb{U}(1)))$$

and

$$o_3(\xi, \beta) := f_*^{-1}o_3^{\mathcal{D}}(\xi, \beta) \in H_{\Gamma,\epsilon}^3(H^0(M, \mathbb{U}(1))).$$

Let us now summarize these results in the following

Theorem 5.3.2. *Let \mathcal{G} be a bundle gerbe over M , let \mathfrak{V} be an open cover of M satisfying the assumptions of Lemma 5.2.2, and let $\xi \in \text{Tot}^2(\mathfrak{V}, \mathcal{D}(2))$ be a cocycle for \mathcal{G} . There are two necessary conditions for the existence of a Γ^ϵ -equivariant structure on \mathcal{G} :*

- 1.) \mathcal{G} has Γ^ϵ -equivariant curvature, and, if so,
- 2.) the obstruction classes $o_{1,x}(\xi)$ and $o_2(\xi)$ vanish.

In the case that both conditions are satisfied, let (α, β) be cochains as above with $\Delta\xi = D\beta$ and $\Delta\beta = -D\alpha$. Then, a sufficient condition for the existence of a Γ^ϵ -equivariant structure on \mathcal{G} is the vanishing of the third obstruction class $o_3(\xi, \beta)$.

Now that we have discussed the obstructions against the existence of Γ^ϵ -equivariant structures, we come to their classification. By Proposition 5.3.1 we have to compute the group $H_{\Gamma,\epsilon}^2(M, \mathcal{D}(2))^1/H^1(M, \mathcal{D}(2))$. For this purpose, we have the following useful

Lemma 5.3.3. *For $n \geq 0$ we have an exact sequence*

$$0 \longrightarrow H_{\Gamma,\epsilon}^2(H^0(M, \mathcal{D}(n))) \longrightarrow H_{\Gamma,\epsilon}^2(M, \mathcal{D}(n))^1 \longrightarrow C_{\Gamma}^1(H^1(M, \mathcal{D}(n))),$$

where the Deligne cohomology groups $H^k(M, \mathcal{D}(n))$ are Γ -modules as explained subsequent to Lemma 5.2.2.

Proof. Recall that $H_{\Gamma,\epsilon}^p(M, \mathcal{D}(n))^1$ is the cohomology of a complex with cochain groups $\text{Tot}_{\Gamma}^k(\mathfrak{V}, \mathcal{D}(n))^1$, where we have omitted one of the direct summands, $C_{\Gamma}^0(A^k)$. If we again split off a direct summand, now $C_{\Gamma}^1(A^{k-1})$, this yields a short exact sequence of complexes

we have defined modified pullback 2-functors x^{\otimes} and used them to define Γ^ϵ -equivariant structures on bundle gerbes. We have also extended the action of Γ to Deligne cohomology in order to classify these Γ^ϵ -equivariant bundle gerbes. Concerning the choice of the group homomorphism ϵ , we now distinguish two situations, namely whether ϵ is trivial, $\epsilon(x) = 1$ for all $x \in \Gamma$, or non-trivial. In this section we discuss the trivial case, and the non-trivial one is to be discussed in the next section.

We call a Γ^ϵ -equivariant structure on a bundle gerbe \mathcal{G} just a Γ -equivariant structure, if ϵ is trivial. Accordingly, a Γ^ϵ -equivariant bundle gerbe is just called Γ -equivariant bundle gerbe. Note that for trivial ϵ , the functor x^{\otimes} is just the pullback by inverse diffeomorphisms,

$$x^{\otimes} = x^* = (x^{-1})^* : \mathfrak{BGrb}(M) \rightarrow \mathfrak{BGrb}(M).$$

To prepare the following definition of a quotient bundle gerbe notice that provided that the action of Γ on M is free, the quotient $X := M/\Gamma$ is a smooth manifold in such a way that the quotient map $p : M \rightarrow X$ is a surjective submersion. If $\pi : Y \rightarrow M$ is the surjective submersion of a bundle gerbe \mathcal{G} over M , the fibre products of the surjective submersion $\omega : Y \rightarrow X$ defined by $\omega := p \circ \pi$ are disjoint unions

$$Y \times_X Y \cong \bigsqcup_{x \in \Gamma} Z_x \quad \text{and} \quad Y \times_X Y \times_X Y \cong \bigsqcup_{(x,y) \in \Gamma^2} Z_{x,y}.$$

Recall from Lemma 5.1.5 that a descended Γ -equivariant structure on \mathcal{G} defines, in the notation of Lemma 5.1.5,

- (a) line bundles A_x over Z_x of curvature $\text{curv}(A_x) = \pi_2^* C - \pi_1^* C$, where C is the curving of \mathcal{G} .
- (b) isomorphisms $\varphi_{x,y} : \pi_{12}^* A_x \otimes \pi_{23}^* A_y \rightarrow \pi_{13}^* A_{xy}$ of line bundles over $Z_{x,y}$ which are associative in the sense of diagram (5-2).

Definition 5.4.1. *Let Γ be a finite group acting smoothly and free on a smooth manifold M , and let $(\mathcal{G}, \mathcal{J})$ be a Γ -equivariant bundle gerbe over M , where we assume that \mathcal{J} is descended. The quotient bundle gerbe \mathcal{G}/Γ over the smooth manifold $X := M/\Gamma$ is defined as follows:*

- (i) *its surjective submersion $\omega : Y \rightarrow X$ is the composition of the surjective submersion $\pi : Y \rightarrow M$ of \mathcal{G} with the quotient map $p : M \rightarrow X$.*
- (ii) *its curving is the curving $C \in \Omega^2(Y)$ of \mathcal{G} .*
- (iii) *its line bundle A over $Y \times_X Y$ is given by the line bundle $A|_{Z_x} := A_x$ of \mathcal{J} over each component Z_x of $Y \times_X Y$.*
- (iv) *its multiplication is over each component $Z_{x,y}$ of $Y \times_X Y \times_X Y$ given by the isomorphism $\varphi_{x,y}$ of \mathcal{J} .*

The axioms (G1) and (G2) for the quotient bundle gerbe follow from Lemma 5.1.5 (a) and (b), respectively.

In order to obtain a correspondence between Γ -equivariant bundle gerbes over M and bundle gerbes over the quotient $X := M/\Gamma$, let now \mathcal{G} be any bundle gerbe over the quotient X . The pullback $\mathcal{H} := p^*\mathcal{G}$ along the quotient map is a bundle gerbe over M which has a canonical (descended) Γ -equivariant structure \mathcal{J}_{can} : since $p = p \circ x^{-1}$ we have $x^*\mathcal{G} = \mathcal{G}$ and are hence able to choose $\mathcal{A}_x := \text{id}_{\mathcal{G}}$. By the same argument, the 2-isomorphism $\varphi_{x,y} : \text{id}_{\mathcal{G}} \circ \text{id}_{\mathcal{G}} \Rightarrow \text{id}_{\mathcal{G}}$ can be chosen to be the natural 2-isomorphism $\varphi_{x,y} := \rho_{\text{id}_{\mathcal{G}}} = \lambda_{\text{id}_{\mathcal{G}}}$. The axiom (2C2) of the 2-category $\mathfrak{BGrb}(M)$ then implies the commutativity condition for the $\varphi_{x,y}$.

Lemma 5.4.2. *For any Γ -equivariant bundle gerbe $(\mathcal{G}, \mathcal{J})$ over M with associated quotient bundle gerbe \mathcal{G}/Γ over X , the Γ -equivariant bundle gerbes $(\mathcal{G}, \mathcal{J})$ and $(p^*(\mathcal{G}/\Gamma), \mathcal{J}_{\text{can}})$ are equivalent.*

Proof. If $\pi : Y \rightarrow M$ is the surjective submersion of \mathcal{G} , the pullback bundle gerbe $\mathcal{H} := p^*(\mathcal{G}/\Gamma)$ has the surjective submersion $\pi' : Y' \rightarrow M$ with $Y' := Y \times \Gamma$ and $\pi'(y, x) := x(\pi(y))$. Its curving is the pullback of the curving C of \mathcal{G} along the projection $y : Y' \rightarrow Y$. Notice that $Y'^{[2]}$ decomposes as a disjoint union of fibre products $W_{x,y} := Y_x \times_M Y_y$ with projections $W_{x,y} \rightarrow Z_{x^{-1}y}$, so that the line bundle L' of the bundle gerbe \mathcal{H} is given by $L'|_{W_{x,y}} := A_{x^{-1}y}$. To define the 1-isomorphism $\mathcal{B} : \mathcal{G} \rightarrow \mathcal{H}$, we write the fibre product $Y \times_M Y'$ as the disjoint union

$$Y \times_M Y' \cong Z := \bigsqcup_{x \in \Gamma} Z_x.$$

We let the line bundle B over Z be defined by $B|_{Z_x} := A_x$. Its curvature satisfies axiom (M1). Notice that $Z^{[2]}$ identifies with the disjoint union of the fibre products $Z_{x,x^{-1}y}$ defined in (5-1). Now we use the following pullbacks of the 2-isomorphisms $\varphi_{x,y}$ to that space,

$$\begin{aligned} \pi_{134}^* \varphi_{1,y} : \pi_{13}^* L \otimes \pi_{34}^* A_y &\rightarrow \pi_{14}^* A_y \\ \text{and } \pi_{124}^* \varphi_{x,x^{-1}y} : \pi_{12}^* A_x \otimes \pi_{24}^* A_{x^{-1}y} &\rightarrow \pi_{14}^* A_y, \end{aligned}$$

so that the composite $\pi_{124}^* \varphi_{x,x^{-1}y}^{-1} \circ \pi_{134}^* \varphi_{1,y}$ defines an isomorphism

$$\beta : \pi_{13}^* L \otimes \pi_{34}^* B \rightarrow \pi_{12}^* B \otimes \pi_{24}^* L'$$

of line bundles over $Z^{[2]}$. It satisfies the axiom (M2) due to the associativity condition for the $\varphi_{x,y}$; hence we have defined a 1-isomorphism $\mathcal{B} = (B, \beta)$.

Now let us compute the canonical Γ -equivariant structure \mathcal{J}_{can} on the pullback bundle gerbe $\mathcal{H} = p^*(\mathcal{G}/\Gamma)$. Its 1-isomorphisms are all $\text{id}_{\mathcal{H}}$; these are 1-isomorphisms consisting of the line bundle L' over $Y'^{[2]}$ and of the isomorphism $\lambda := \pi_{124}^* \varphi^{-1} \circ \pi_{134}^* \varphi$ over $Y'^{[3]}$. We have in turn to compute the equivariant structure $\mathcal{J}_{\mathcal{B}}(\mathcal{J}_{\text{can}})$ on \mathcal{G} . By definition of the functor $\mathcal{J}_{\mathcal{B}}$ in Proposition 5.1.3 it consists of the 1-isomorphisms $\mathcal{A}'_x := x^* \mathcal{B}^{-1} \circ \text{id}_{\mathcal{H}} \circ \mathcal{B}$, these are given by the fibre product

$$Z'_x := \bigsqcup_{y,z \in \Gamma} Z_{y,y^{-1}xz,z^{-1}}$$

and the line bundle A'_x over Z'_x given by

$$A'_x|_{Z_{y,y^{-1}xz,z^{-1}}} := \pi_{12}^* A_y \otimes \pi_{23}^* A_{y^{-1}xz} \otimes \pi_{34}^* s^* A_z^*.$$

To finish the proof, we need to define a morphism $\gamma : J_{\mathcal{B}}(\mathcal{J}_{\text{can}}) \rightarrow \mathcal{J}$ of Γ -equivariant structures on \mathcal{G} . We define the 2-isomorphism $\gamma_x : \mathcal{A}'_x \Rightarrow \mathcal{A}_x$ by the triple $(Z'_x, \text{id}, \gamma_x)$ where γ_x is composed as

$$\begin{array}{ccc} \pi_{12}^* A_y \otimes \pi_{23}^* A_{y^{-1}xz} \otimes \pi_{34}^* s^* A_z^* & \xrightarrow{\pi_{123}^* \varphi_{y,y^{-1}xz} \otimes \text{id}} & \pi_{13}^* A_{xz} \otimes \pi_{43}^* A_z^* \\ & & \downarrow \pi_{143}^* \varphi_{x,y}^{-1} \otimes \text{id} \\ & & \pi_{14}^* A_x \otimes \pi_{43}^* A_z \otimes \pi_{43}^* A_z^* = \pi_{14}^* A_x. \end{array}$$

This 2-isomorphism satisfies the condition on morphisms of Γ -equivariant structures due to the associativity condition for the $\varphi_{x,y}$. \blacksquare

Quotient bundle gerbes are useful to produce examples of bundle gerbes over manifolds M/Γ from given bundle gerbes over M . For instance, we can take the bundle gerbes \mathcal{G}_0^k over a compact simple, simply-connected Lie group G we have constructed in §1.4, and consider the action of a subgroup Z of the (finite) center of G by multiplication,

$$z : G \rightarrow G : g \mapsto z \cdot g.$$

Recall that the bundle gerbes \mathcal{G}_0^k have the curvature $\text{curv}(\mathcal{G}_0^k) = k\eta$, and that the 3-form $\eta \in \Omega^3(G)$ is bi-invariant. In particular, \mathcal{G}_0^k has Z -equivariant curvature.

By Proposition 5.3.4 (a), the remaining obstruction against Z -equivariant structures on \mathcal{G}_0^k is the class $o_3(k) := o_3(\mathcal{G}_0^k)$ in the group cohomology $H_Z^3(\text{U}(1))$, where $\text{U}(1)$ is the trivial Z -module. The subgroups Z in question are either $Z = \mathbb{Z}_m$ or $Z = \mathbb{Z}_2 \times \mathbb{Z}_2$ in the case $G = \text{Spin}(4n)$. Their cohomology is [Wei94]

$$H_{\mathbb{Z}_m}^q(\text{U}(1)) = \begin{cases} \text{U}(1) & \text{if } q = 0 \\ 0 & \text{if } q \text{ even} \\ \mathbb{Z}_m & \text{if } q \text{ odd} \end{cases} \quad (5-8)$$

and, via the Künneth formula,

$$H_{\mathbb{Z}_2 \times \mathbb{Z}_2}^q(\text{U}(1)) = \begin{cases} \mathbb{Z}_2 & q = 2 \\ \mathbb{Z}_2 \times \mathbb{Z}_2 & q = 3 \end{cases} \quad (5-9)$$

Since the group $H_Z^3(\mathbb{U}(1))$ itself does not vanish, the obstruction classes $o_3(k)$ of the bundle gerbes \mathcal{G}_0^k have to be derived explicitly. This has been done using the construction from §1.4, and the enhanced constructions from [GR03]. The results are collected in Table 5.1 on page 143.

By Proposition 5.3.4 (b), equivalence classes of Z -equivariant bundle gerbes whose underlying bundle gerbe is isomorphic to \mathcal{G}_0^k are classified by $H_Z^2(\mathbb{U}(1))$, which vanishes in all cases except $G = \text{Spin}(4n)$ where it is \mathbb{Z}_2 . This is an important result for the classification of Wess-Zumino-Witten models with non-simply connected target spaces, as we shall see later.

Let us next investigate how the definition of the quotient bundle gerbes depends on the bundle gerbe \mathcal{G} and the equivariant structure \mathcal{J} .

Lemma 5.4.3. *Suppose that the Γ -equivariant bundle gerbes $(\mathcal{G}, \mathcal{J})$ and $(\mathcal{G}', \mathcal{J}')$ over M are equivalent in the sense of Definition 5.1.6. Then, the quotient bundle gerbes \mathcal{G}/Γ and \mathcal{G}'/Γ over X are isomorphic.*

Proof. Let $\mathcal{B} : \mathcal{G} \rightarrow \mathcal{G}'$ be a 1-isomorphism, and let $\beta : \mathcal{J} \Rightarrow J_{\mathcal{B}}(\mathcal{J}')$ be a morphism of Γ -equivariant structures on \mathcal{G} . We may assume for simplicity that both equivariant structures are descended and that \mathcal{B} and β live in the Hom-category \mathfrak{Hom}_{FP} . So, \mathcal{B} consists of a line bundle B over $Z := Y \times_M Y'$, and of an isomorphism β of line bundles over $Z \times_M Z$. The equivariant structure $J_{\mathcal{B}}(\mathcal{J}')$ has 1-isomorphisms $x^{\otimes} \mathcal{B}^{-1} \circ \mathcal{A}'_x \circ \mathcal{B}$ with line bundles $\pi_{12}^* B \otimes \pi_{23}^* A'_x \otimes \pi_{34}^* s^* B$ over a component $Y \times_M Z'_x \times_M Y_x$ in the notation of Lemma 5.1.5. Thus, the morphism β of Γ -equivariant structures has isomorphisms

$$\beta_x : \pi_{14}^* A_x \rightarrow \pi_{12}^* B \otimes \pi_{23}^* A'_x \otimes \pi_{34}^* s^* B^*$$

of line bundles over $Y \times_M Z'_x \times_M Y_x$. Notice that β_1 coincides with the isomorphism of \mathcal{B} .

Now we define a 1-isomorphism $\tilde{\mathcal{B}} : \mathcal{G}/\Gamma \rightarrow \mathcal{G}'/\Gamma$. Consider the surjective submersion $\pi_{13} : \tilde{Z}_x := Z \times_{Y'} Z'_x \rightarrow Y \times_M Y'_x$ into the component $Y \times_M Y'_x$ of the fibre product of the surjective submersions of the two quotient bundle gerbes, and the line bundle $\tilde{B}|_{\tilde{Z}_x} := B \otimes A'_x$, which has the correct curvature:

$$\text{curv}(\tilde{B}_x) = \text{curv}(B) + \text{curv}(A'_x) = \pi_3^* C' - \pi_2^* C + \pi_2^* C - \pi_1^* C = \pi_3^* C' - \pi_1^* C.$$

To define the isomorphism of $\tilde{\mathcal{B}}$, we consider the fibre product

$$\tilde{Z}_x \times_X \tilde{Z}_y \cong \bigsqcup_{z \in \Gamma} Y \times_M Y' \times_M Y'_x \times_M Y_{xy} \times_M Y'_{xy} \times_M Y'_{xyz}$$

and set

$$\begin{array}{c}
\pi_{14}^* A_{xy} \otimes \pi_{456}^* \tilde{B}_z \longequal{\quad} \pi_{14}^* A_{xy} \otimes \pi_{45}^* B \otimes \pi_{56}^* A'_z \\
\downarrow \pi_{1254}^* \beta_{xy} \otimes \text{id} \otimes \text{id} \\
\pi_{12}^* B \otimes \pi_{25}^* A'_{xy} \otimes \pi_{56}^* A'_z \\
\downarrow \text{id} \otimes \pi_{256}^* \varphi'_{x,y,z} \\
\pi_{12}^* B \otimes \pi_{25}^* A'_{xyz} \\
\downarrow \text{id} \otimes \pi_{236}^* \varphi'^{-1}_{x,y,z} \\
\pi_{12}^* B \otimes \pi_{23}^* A'_x \otimes \pi_{36}^* A'_{yz} \longequal{\quad} \pi_{123}^* \tilde{B}_x \otimes \pi_{36}^* A'_{yz}.
\end{array}$$

This isomorphism satisfies axiom (1M2) due to the commutative diagram for the isomorphisms β_{xy} from Definition 5.1.2 and the one for the $\varphi'_{x,y}$ from Definition 5.1.1. \blacksquare

With this result, we have established that forming the quotient bundle gerbe defines a map from the set of equivalence classes of Γ -equivariant bundle gerbes over M to the set of 1-isomorphism classes of bundle gerbes over the quotient X . It is not hard to see that this map is even a group homomorphism.

Proposition 5.4.4. *The assignment of a quotient bundle gerbe \mathcal{G}/Γ over X to every Γ -equivariant bundle gerbe $(\mathcal{G}, \mathcal{J})$ over M establishes a group isomorphism*

$$\left\{ \begin{array}{c} \text{Equivalence classes} \\ \text{of } \Gamma\text{-equivariant} \\ \text{bundle gerbes over } M \end{array} \right\} \xrightarrow{\cong} \left\{ \begin{array}{c} \text{Isomorphism classes} \\ \text{of bundle gerbes} \\ \text{over } X := M/\Gamma \end{array} \right\}.$$

Proof. With Lemma 5.4.2 we have shown that we have a left inverse group homomorphism, namely the pullback p^* along the quotient map $p : M \rightarrow X$. To see that this is also a right inverse, assume a bundle gerbe \mathcal{G} over X . We have to show that it is isomorphic to the quotient bundle gerbe $(p^*\mathcal{G})/\Gamma$. Let $\pi : Y \rightarrow X$ be the surjective submersion of \mathcal{G} , so that the pullback bundle gerbe $p^*\mathcal{G}$ has the projection from $Y' := M \times_X Y$ to the first component as its surjective submersion, and the quotient bundle gerbe $p^*\mathcal{G}/\Gamma$ the projection from Y' to X . Notice that the projection $f : Y' \rightarrow Y$ on the second component defines a morphism of surjective submersions over X . From the definition of the canonical equivariant structure \mathcal{J}_{can} on $p^*\mathcal{G}$ and the one of the quotient bundle gerbe it follows that $\mathcal{G}_f = (p^*\mathcal{G})/\Gamma$, where \mathcal{G}_f is the bundle gerbe over X which is isomorphic to \mathcal{G} by Lemma 1.2.3. \blacksquare

For the corresponding cohomology theories from Theorems 1.3.6 and 5.2.4, the latter Proposition infers a bijection

$$H_\Gamma^2(M, \mathcal{D}(2)) \cong H^2(M/\Gamma, \mathcal{D}(2)).$$

This bijection can also be defined explicitly for representing cochains [GR02].

To close this section, let us draw some conclusions concerning Wess-Zumino-Witten models.

Definition 5.4.5. *A Wess-Zumino-Witten orbifold is a Wess-Zumino-Witten model for oriented worldsheets together with a finite subgroup Z of the center of the target space G and a Z -equivariant structure \mathcal{J} on \mathcal{G} for the action of Z on G by multiplication.*

Any Wess-Zumino-Witten orbifold $(G, \langle -, - \rangle, \mathcal{G}, Z, \mathcal{J})$ defines a Wess-Zumino-Witten model for oriented worldsheets on the Lie group G/Z : since G and G/Z have the same Lie algebra \mathfrak{g} , we use the same bilinear form $\langle -, - \rangle$ on the quotient, and furthermore the bundle gerbe \mathcal{G}/Z . It remains to check the curvature condition from Definition 1.6.6: the left invariant Maurer-Cartan-form $\theta_G \in \Omega^1(G, \mathfrak{g})$ descends to the left invariant Maurer-Cartan-form $\theta_{G/Z}$ on G/Z , and so does the 3-form η_G . Hence, the curvature of the quotient bundle gerbe is $k\eta_{G/Z}$.

Conversely, every Wess-Zumino-Witten model with target space G/Z defines a Wess-Zumino-Witten orbifold with target space G . By Proposition 5.4.4, we have encountered a bijection between gauge equivalence classes of Wess-Zumino-Witten orbifolds with target space G and Wess-Zumino-Witten models with target space G/Z .

This result has been used to classify all Wess-Zumino-Witten models whose target space is a compact simple Lie group by classifying equivariant structures on bundle gerbes [GR03], the results collected in Table 5.1. They reproduce earlier results [FGK88] in a geometric way, and explain in particular why there are two different Wess-Zumino-Witten models with target space $\text{Spin}(4n)/(\mathbb{Z}_2 \times \mathbb{Z}_2)$, a phenomenon which is called *discrete torsion* in the literature: the two models correspond to the two inequivalent $(\mathbb{Z}_2 \times \mathbb{Z}_2)$ -equivariant bundle gerbes over $\text{Spin}(4n)$.

G		Center	k	$o_3(k) = 0$ if...	$ H_Z^2(U(1)) $
SU(n)		\mathbb{Z}_n	even odd	always $ Z $ odd or $\frac{n}{ Z }$ even	1
Spin(n)	$n = 2r + 1$	\mathbb{Z}_2	all	always	1
	$n = 4r + 2$	\mathbb{Z}_4	even odd	always $ Z = 2$	1
	$n = 4r$	$\mathbb{Z}_2 \times \mathbb{Z}_2$	even odd	always n even	2
Sp($2n$)		\mathbb{Z}_2	even odd	always n even	1
E ₆		\mathbb{Z}_3	all	always	1
E ₇		\mathbb{Z}_2	even odd	always never	1

Table 5.1: Obstructions and classification of equivariant structures on the bundle gerbes \mathcal{G}_0^k over compact, simple and simply-connected Lie groups. For example, the bundle gerbe \mathcal{G}_0^k over Spin(6) admits Z -equivariant structures, if k is even or if $Z = \mathbb{Z}_2$.

5.5 Jandl Structures on Quotient Bundle Gerbes

Let us start this section with a first glimpse on the relation between Γ^ϵ -equivariant structures on a bundle gerbe \mathcal{G} over M and Jandl structures on \mathcal{G} for the case that Γ is the group $\Gamma = \mathbb{Z}_2$ with $\epsilon = \text{id}$. Its action on M is an involution denoted by $k : M \rightarrow M$. Note that $k^\otimes = ()^\dagger \circ k^*$. According to the normalization convention described after Definition 5.1.1, a \mathbb{Z}_2^{id} -equivariant structure consists of one 1-isomorphism $\mathcal{A}_k : \mathcal{G} \rightarrow k^*\mathcal{G}^*$ and one 2-isomorphism $\varphi_{k,k} : k^*\mathcal{A}_k^\dagger \circ \mathcal{A}_k \Rightarrow \text{id}_{\mathcal{G}}$; and the commutative diagram becomes the equality

$$\rho_{\mathcal{A}_k} \bullet (k^*\varphi_{k,k}^\dagger \circ \text{id}) = \lambda_{\mathcal{A}_k} \bullet (\text{id} \circ \varphi_{k,k}) \tag{5-10}$$

of 2-isomorphisms from $\mathcal{A}_k \circ k^*\mathcal{A}_k^\dagger \circ \mathcal{A}_k$ to \mathcal{A}_k . This does not reproduce exactly the Definition 4.2.1 of a Jandl structure due to conventional choices we had to make in order to use Deligne cohomology. However, the 1-isomorphism $\mathcal{A} := k^*\mathcal{A}_k$ and the 2-isomorphism φ defined by

$$k^*\mathcal{A} \xrightarrow{\rho_{k^*\mathcal{A}}^{-1}} \text{id}_{\mathcal{G}} \circ k^*\mathcal{A} \xrightarrow{i_{r \circ \text{id}_{k^*\mathcal{A}}}} \mathcal{A}^* \circ \mathcal{A}^\dagger \circ k^*\mathcal{A} \xrightarrow{\text{id}_{\mathcal{A}^*} \circ \varphi_{k,k}} \mathcal{A}^* \circ \text{id}_{\mathcal{G}} \xrightarrow{\lambda_{\mathcal{A}^*}} \mathcal{A}^*$$

yield a Jandl structure as defined before. In the same way one can check that two \mathbb{Z}_2^{id} -equivariant bundle gerbes are equivalent in the sense of Definition

5.1.6 if and only if the respective Jandl gerbes are equivalent in the sense of Definition 4.2.6. Together with Theorem 5.2.4, this gives

Corollary 5.5.1. *The group of equivalence classes of Jandl gerbes over M is isomorphic to the twisted equivariant Deligne cohomology group $H_{\mathbb{Z}_2, \text{id}}^2(M, \mathcal{D}(2))$.*

Now let us return to the general case of a smooth action of a finite group Γ on a manifold M , where we now assume in contrast to the previous section that the group homomorphism $\epsilon : \Gamma \rightarrow \mathbb{Z}_2$ is non-trivial, i.e. surjective. The kernel of ϵ is the normal subgroup Z , and we have an exact sequence

$$0 \longrightarrow Z \longrightarrow \Gamma \xrightarrow{\epsilon} \mathbb{Z}_2 \longrightarrow 0,$$

of groups. For the action of Γ on M we make the assumption of the following definition.

Definition 5.5.2. *An orientifold group for a smooth manifold M is a finite group Γ acting smoothly on M , together with a surjective group homomorphism $\epsilon : \Gamma \rightarrow \mathbb{Z}_2$, such that the induced action of the normal subgroup $Z := \ker \epsilon$ on M is free.*

Thus, if (Γ, ϵ) is an orientifold group for M , the quotient $X := M/Z$ is again a smooth manifold as discussed in the previous section. Note that a Γ^ϵ -equivariant structure \mathcal{J} on \mathcal{G} restricts to a Z -equivariant structure. This implies that we have a quotient bundle gerbe \mathcal{G}/Z over X , given by the explicit construction from the previous section. In the following we show that the full Γ^ϵ -equivariant structure defines a Jandl structure \mathcal{J}/Z on the quotient bundle gerbe \mathcal{G}/Z . The first ingredient – an involution – is provided by the following

Proposition 5.5.3. *Let (Γ, ϵ) be an orientifold group for M with normal subgroup Z . Then, there is a unique involution $k : X \rightarrow X$ on the quotient $X := M/Z$ such that for any element $x \in \Gamma$ with $\epsilon(x) = -1$ the diagram*

$$\begin{array}{ccc} M & \xrightarrow{x} & M \\ p \downarrow & & \downarrow p \\ X & \xrightarrow{k} & X \end{array}$$

is commutative, where $p : M \rightarrow X$ is the projection in the quotient.

Proof. The involution k is the action of $\Gamma/Z \cong \mathbb{Z}_2$ on $M/Z = X$. By definition of the smooth structure on X , the commutativity of the diagram shows that k is a smooth map. ■

Now we construct the remaining parts of the Jandl structure \mathcal{J}/Z on \mathcal{G}/Z , which we understand here as a \mathbb{Z}_2^{id} -equivariant structure. Recall first

from Lemma 5.1.5 that the Γ^ϵ -equivariant Jandl structure, which we assume to be descended, defines for each $x \in \Gamma$ a line bundle A_x over Z_x of curvature

$$\text{curv}(A_x) = \epsilon(x)\pi_2^*C - \pi_1^*C,$$

and for each pair $x, y \in \Gamma$ an isomorphism

$$\varphi_{x,y} : \pi_{12}^*A_x \otimes \pi_{23}^*A_y^{\epsilon(x)} \rightarrow \pi_{13}^*A_{xy}$$

of line bundles over $Z_{x,y}$ which is associative in the sense that diagram (5-2) is commutative. Recall further that the quotient bundle gerbe \mathcal{G}/Z is defined on the surjective submersion $\omega : Y \rightarrow X$ whose two- and three-fold fibre products are disjoint unions of the smooth manifolds Z_x and $Z_{x,y}$, respectively, for $x, y \in Z$. The line bundle A of \mathcal{G}/Z is the union of the line bundles A_x over the component Z_x , and its multiplication is the union of the isomorphisms $\varphi_{x,y}$ over the component $Z_{x,y}$.

Let us for simplicity denote by $\Gamma^- \subset \Gamma$ the subset of elements $x \in \Gamma$ with $\epsilon(x) = -1$. To define a Jandl structure on the quotient bundle gerbe \mathcal{G}/Z we use the remaining structure, namely the line bundles A_x over Z_x for $x \in \Gamma^-$, and the isomorphisms $\varphi_{x,y}$ for elements $x, y \in \Gamma$ with either $x \in \Gamma^-$ or $y \in \Gamma^-$. The 1-isomorphism $\mathcal{A} : \mathcal{G} \rightarrow k^*\mathcal{G}^*$ is defined as follows: the fibre product $P := Y \times_X Y_k$ of the surjective submersions of the two bundle gerbes can be written as

$$P \cong \bigsqcup_{x \in \Gamma^-} Z_x,$$

and the line bundle A over P is defined as $A|_{Z_x} := A_x$. It has the correct curvature $\text{curv}(A) = -\pi_2^*C - \pi_1^*C$ in the sense of axiom (1M1). The two-fold fibre product has the components

$$P \times_X P \cong \bigsqcup_{x,y,z \in \Gamma^-} Z_{x,y,z}$$

Now we have to define an isomorphism α of line bundles over $P \times_X P$, which is on the component $Z_{x,y,z}$ an isomorphism

$$\alpha|_{Z_{x,y,z}} : \pi_{13}^*A_{xy} \otimes \pi_{34}^*A_z \rightarrow \pi_{12}^*A_x \otimes \pi_{24}^*A_{yz}^*,$$

where we have a dual line bundle because the target of the isomorphism \mathcal{A} is the dual bundle gerbe. We define this isomorphism as the composition of

$$\pi_{134}^*\varphi_{xy,z} : \pi_{13}^*A_{xy} \otimes \pi_{34}^*A_z \rightarrow \pi_{14}^*A_{xyz},$$

where here is no dual line bundle since $\epsilon(xy) = 1$, with the inverse of

$$\pi_{124}^*\varphi_{x,yz} : \pi_{12}^*A_x \otimes \pi_{24}^*A_{yz}^* \rightarrow \pi_{14}^*A_{xyz}.$$

The isomorphism α defined like this satisfies axiom (1M2) for 1-morphisms due to the commutativity condition on the isomorphism $\varphi_{x,y}$ from Lemma 5.1.5. This completes the definition of the 1-isomorphism \mathcal{A} .

We are left with the definition of the 2-isomorphism $\varphi : k^* \mathcal{A}_k^\dagger \circ \mathcal{A}_k \Rightarrow \text{id}_{\mathcal{G}}$, for which we use the remaining structure, namely the 1-isomorphisms $\varphi_{x,y}$ for $x, y \in \Gamma^-$. We represent φ as a triple (W, id, φ) where $W = P \times_X Y$, which can be written as

$$W \cong \bigsqcup_{x,y \in \Gamma^-} Z_{x,y}.$$

Then, over the component $Z_{x,y}$, the isomorphism φ is an isomorphism

$$\varphi|_{Z_{x,y}} : \pi_{12}^* A_x \otimes \pi_{23}^* A_y^* \rightarrow \pi_{13}^* A_{xy}$$

of line bundles, since the 1-isomorphism $\text{id}_{\mathcal{G}}$ has the line bundle of the bundle gerbe \mathcal{G}/Z , which is A_{xy} . We define $\varphi|_{Z_{x,y}} := \varphi_{x,y}$. The axiom (2M) for the triple (W, id, φ) can be deduced from the commutativity condition for the 2-isomorphisms $\varphi_{x,y}$.

Finally we have to assure that the 2-isomorphism φ satisfies the equation (5–10) for Jandl structures. To see this, we have to express the natural 2-isomorphisms $\rho_{\mathcal{A}}$ and $\lambda_{\mathcal{A}}$ by the given 2-isomorphisms $\varphi_{x,y}$. According to their definition in §2.3, we find $\rho_{\mathcal{A}}|_{Z_{x,y}} = \varphi_{x,y}$ and $\lambda_{\mathcal{A}}|_{Z_{x,y}} = \varphi_{y,x}$ for $x \in \Gamma^-$ and $y \in Z$. Then, equation (5–10) reduces to the commutativity condition for the 2-isomorphisms $\varphi_{x,y}$. This finishes the definition of the Jandl structure \mathcal{J}/Z on the bundle gerbe \mathcal{G}/Z .

Concerning the relation between Jandl gerbes on the quotient and Γ^ϵ -equivariant bundle gerbes over M , all statements from the previous section generalize. For example, on the pullback bundle gerbe $p^*(\mathcal{G}/Z)$, the Jandl structure $p^*(\mathcal{J}/Z)$ and the canonical Γ -equivariant structure \mathcal{J}_{can} combine to a canonical Γ^ϵ -equivariant structure, which is still denoted by $p^*(\mathcal{J}/Z)$.

Lemma 5.5.4. *For the quotient Jandl gerbes we have the following generalizations of Lemmata 5.4.2 and 5.4.3 for quotient bundle gerbes:*

- (i) *For any Γ^ϵ -equivariant bundle gerbe $(\mathcal{G}, \mathcal{J})$ over M with associated quotient Jandl gerbe $(\mathcal{G}/Z, \mathcal{J}/Z)$ over X , the Γ^ϵ -equivariant bundle gerbes $(\mathcal{G}, \mathcal{J})$ and $p^*(\mathcal{G}/Z, \mathcal{J}/Z)$ are equivalent.*
- (ii) *Suppose that the Γ^ϵ -equivariant bundle gerbes $(\mathcal{G}, \mathcal{J})$ and $(\mathcal{G}', \mathcal{J}')$ over M are equivalent. Then, the Jandl gerbes $(\mathcal{G}/Z, \mathcal{J}/Z)$ and $(\mathcal{G}'/Z, \mathcal{J}'/Z)$ over X are also equivalent.*

Proof. In the proof of Lemma 5.4.2 we have constructed a 1-isomorphism $\mathcal{B} : \mathcal{G} \rightarrow p^*(\mathcal{G}/Z)$ and a morphism $\gamma : J_{\mathcal{B}}(\mathcal{J}_{\text{can}}) \rightarrow \mathcal{J}$ of Z -equivariant structures on \mathcal{G} . The definition of the quotient Jandl structure \mathcal{J}/Z shows that the definition of the 2-isomorphism γ_x extends from group elements $x \in Z$ to those in Γ^- . This defines the equivalence (i). For the second claim, we recall from the proof of Lemma 5.4.3 the construction of a 1-isomorphism $\tilde{\mathcal{B}} : \mathcal{G}/Z \rightarrow \mathcal{G}'/Z$ from a given 1-isomorphism $\mathcal{B} : \mathcal{G} \rightarrow \mathcal{G}'$ and a morphism $\beta : \mathcal{J} \rightarrow J_{\mathcal{B}}(\mathcal{J}')$ of Γ^ϵ -equivariant structures on \mathcal{G} . To prove (ii), we construct a morphism

$\tilde{\beta} : \mathcal{J}/Z \rightarrow J_{\tilde{\mathcal{B}}}(\mathcal{J}'/Z)$ of Jandl structures on \mathcal{G}/Z . In the notation of Lemma 5.4.3, this is a 2-morphism

$$\tilde{\beta} : \mathcal{A} \Rightarrow k^* \tilde{B}^* \circ \mathcal{A}' \circ \tilde{B}.$$

It is defined as an isomorphism of line bundles over $\tilde{Z} \times_{Y'} P' \times_{Y'} \tilde{Z}$, which we write as a disjoint union

$$\tilde{Z} \times_{Y'} P' \times_{Y'} \tilde{Z} = \bigsqcup_{x \in \Gamma^-, y \in Z} Y \times_M Y' \times_{Y'_y} \times_M Y'_{xy} \times_M Y'_x \times_M Y_x.$$

We use the isomorphisms β_x of the morphism β of Γ^ϵ -equivariant structures, now for $x \in \Gamma^-$ and define $\tilde{\beta}_{x,y}$ by

$$\begin{array}{ccc} \pi_{16}^* A_x & & \\ \downarrow \pi_{1256}^* \beta_x & & \\ \pi_{12}^* B \otimes \pi_{25}^* A'_x \otimes \pi_{65}^* B & \xrightarrow{\text{id} \otimes \pi_{254}^* \varphi_{x,y} \otimes \text{id}} & \pi_{12}^* B \otimes \pi_{24}^* A'_{xy} \otimes \pi_{54}^* A'_y \otimes \pi_{65}^* B \\ & & \downarrow \text{id} \otimes \pi_{234}^* \varphi_{y,y^{-1}xy}^{-1} \otimes \text{id} \\ & & \pi_{12}^* B \otimes \pi_{23}^* A'_y \otimes \pi_{34}^* A'_{y^{-1}xy} \otimes \pi_{54}^* A'_y \pi_{65}^* B \end{array}$$

This 2-morphisms satisfies the condition on morphisms of Jandl structures from Definition 5.1.2. \blacksquare

Due to (ii), we have a well-defined map from the set of equivalence classes of Γ^ϵ -equivariant bundle gerbes over M and Jandl gerbes over M/Γ . It is further a group homomorphism.

Theorem 5.5.5. *Let (Γ, ϵ) be an orientifold group for M . The assignment of a quotient Jandl gerbe $(\mathcal{G}/\Gamma, \mathcal{J}/Z)$ over X to every Γ^ϵ -equivariant bundle gerbe $(\mathcal{G}, \mathcal{J})$ over M establishes a group isomorphism*

$$\left\{ \begin{array}{l} \text{Equivalence classes} \\ \text{of } \Gamma^\epsilon\text{-equivariant} \\ \text{bundle gerbes over } M \end{array} \right\} \xrightarrow{\cong} \left\{ \begin{array}{l} \text{Isomorphism classes} \\ \text{of Jandl gerbes} \\ \text{over } X := M/\Gamma \end{array} \right\}.$$

Proof. We recall from the proof of Proposition 5.4.4 that for a bundle gerbe \mathcal{G} over X , we have the relation $\mathcal{G}_f = (p^* \mathcal{G})/Z$ where f is a certain morphism of surjective submersions over X . Let $\mathcal{B} : \mathcal{G}_f \rightarrow \mathcal{G}$ be the 1-isomorphism from Lemma 1.2.3. Using the natural 2-isomorphism $\lambda_{\mathcal{A}}$ and $\rho_{\mathcal{A}}$ from the 2-category $\mathfrak{BGrb}(X)$, one can deduce a morphism $(p^* \mathcal{J})/Z \rightarrow J_{\mathcal{B}}(\mathcal{J})$ of Jandl structures on \mathcal{G}_f . Thus, the Jandl gerbes $(\mathcal{G}, \mathcal{J})$ and $(p^* \mathcal{G}, p^* \mathcal{J})/Z$ are equivalent. The injectivity follows from Lemma 5.5.4 (i). \blacksquare

For the cohomology theories from Theorem 5.2.4 and Corollary 5.5.1, the latter theorem infers a bijection

$$H_{\Gamma, \epsilon}^2(M, \mathcal{D}(2)) \cong H_{\mathbb{Z}_2, \text{id}}^2(M/Z, \mathcal{D}(2)).$$

This bijection can again be defined explicitly for representing cochains [GSW]. In the next section we discuss an application of Theorem 5.5.5.

5.6 Application: Wess-Zumino-Witten Orientifolds

In §5.4 we have used the theory of equivariant bundle gerbes to produce bundle gerbes over quotients M/Γ of a smooth manifold M by a finite group Γ . In particular, for $M = G$ a compact simple and simply-connected Lie group and $\Gamma = Z$ a subgroup of its center, we have classified all bundle gerbes over all compact simple Lie groups, whose curvature is an integer multiple $k\eta$ of the 3-form η on G/Z .

In this section, we extend these results to the classification of all Jandl gerbes over all compact simple Lie groups with this curvature. For this purpose, we consider the following orientifold group (Γ, ϵ) : the group Γ is the semidirect product $\Gamma = \mathbb{Z}_2 \ltimes Z$ of a subgroup Z of the center of G with \mathbb{Z}_2 , where \mathbb{Z}_2 acts on Z by inversion. Explicitly, this is the set $\mathbb{Z}_2 \times Z$, equipped with the product

$$(\epsilon_1, z_1) \cdot (\epsilon_2, z_2) := (\epsilon_1 \epsilon_2, z_1^{\epsilon_2} z_2)$$

for $\epsilon_i = \pm 1$ and $z \in Z$. In the case that $Z = \mathbb{Z}_n$ for some n , this is just the dihedral group D_{2n} . The surjective group homomorphism $\epsilon : \mathbb{Z}_2 \ltimes Z \rightarrow \mathbb{Z}_2$ is the projection on the first component. The action of Γ on G is defined for elements $z \in Z$ as before,

$$(1, z) : G \rightarrow G : g \mapsto z \cdot g,$$

and by

$$(-1, 1) : G \rightarrow G : g \mapsto \zeta \cdot g^{-1}$$

for a fixed element ζ in the center of G (not necessarily in Z). The element ζ is called the *twist element*. For an element $(-1, z) \in \Gamma$, the action is determined by the above definitions due to $(-1, z) = (-1, 1) \cdot (1, z)$.

Definition 5.6.1. *A Wess-Zumino-Witten orientifold is a Wess-Zumino-Witten model for unoriented worldsheets together with a finite subgroup Z of the center of its target space G and a Γ^ϵ -equivariant structure on its bundle gerbe \mathcal{G} , where $\Gamma = \mathbb{Z}_2 \ltimes Z$ is the orientifold group defined above.*

Any Wess-Zumino-Witten orientifold defines a Wess-Zumino-Witten model for unoriented worldsheets on the quotient G/Z and this is in fact an equivalence. So we have reduced the classification of Wess-Zumino-Witten

models for unoriented worldsheets whose target space is a compact simple Lie group G/Z to the classification of Γ^ϵ -equivariant basic bundle gerbes over the compact, simple and simply-connected Lie group G . By Proposition 5.3.4, this amounts to compute the obstruction classes $o_3(\mathcal{G}_0^k) \in H_{\Gamma, \epsilon}^3(\mathbb{U}(1))$ of the basic bundle gerbes and the classifying cohomology group $H_{\Gamma, \epsilon}^2(\mathbb{U}(1))$.

The calculation of the relevant group cohomology groups are – compared to the group cohomology calculations in §5.4 – more difficult, firstly because Γ is non-abelian unless $Z \cong \mathbb{Z}_2 \times \dots \times \mathbb{Z}_2$, and secondly because now $\mathbb{U}(1)$ is a non-trivial Γ -module, where (ϵ, z) acts by $\lambda \mapsto \lambda^\epsilon$ for $\lambda \in \mathbb{U}(1)$. A lot of these calculations can be covered by the Lyndon-Hochschild-Serre spectral sequence.

Theorem 5.6.2 (Lyndon/Hochschild-Serre [Wei94]). *Let Γ be a group with a normal subgroup Z and a left module M . Then there is a first quadrant spectral sequence $E_r^{p,q}$ with*

$$E_2^{p,q} := H_{\Gamma/Z}^p(H_Z^q(M))$$

which converges to the group cohomology of Γ with values in M ,

$$E_r^{p,q} \Rightarrow H_{\Gamma}^{p+q}(M).$$

Recall that a first quadrant spectral sequence $E_r^{p,q}$ consists of pages $E_r^{\bullet, \bullet}$, which are bi-graded groups with $E_r^{p,q} = 0$ unless $p \geq 0$ and $q \geq 0$, and which are equipped with a family of group homomorphisms

$$d_r^{p,q} : E_r^{p,q} \rightarrow E_r^{p+r, q-r+1}$$

satisfying $d_r^{p+r, q-r+1} \circ d_r^{p,q} = 0$. From a given r th page one determines the groups of the next page as the graded cohomology $E_{r+1}^{p,q} := H^{p,q}(E_r, d)$. Recall further that the symbol $E_r^{p,q} \Rightarrow H_{\Gamma}^{p+q}(M)$ means that there exists a number n for each pair (p, q) , such that $E_n^{p,q} = E_{n+1}^{p,q} = \dots$, and a filtration

$$0 = F_{k+1}^k \subset F_k^k \subset \dots \subset F_1^k \subset F_0^k = H_{\Gamma}^k(M)$$

such that

$$F_p^k / F_{p+1}^k \cong E_n^{p, k-p}.$$

In our example of the orientifold group $\Gamma = \mathbb{Z}_2 \ltimes Z$, for which Z is in particular a normal subgroup and ϵ induces an isomorphism $\Gamma/Z \rightarrow \mathbb{Z}_2$ the second page of the Lyndon-Hochschild-Serre spectral sequence is

$$E_2^{p,q} = H_{\mathbb{Z}_2, \text{id}}^p(H_Z^q(\mathbb{U}(1))),$$

where the action of \mathbb{Z}_2 on $H_Z^q(\mathbb{U}(1))$ is given by

$$(-1 \cdot n)_{x_0, \dots, x_q} := n_{x_0^{-1}, \dots, x_q^{-1}} \quad (5-11)$$

for a cocycle $n \in C_Z^q(U(1))$. Let us start with the cyclic group $Z = \mathbb{Z}_m$ for which we have stated the cohomology groups $H_Z^q(U(1))$ in §5.4, see (5–8), namely

$$H_{\mathbb{Z}_m}^q(U(1)) = \begin{cases} U(1) & \text{if } q = 0 \\ 0 & \text{if } q \text{ even} \\ \mathbb{Z}_m & \text{if } q \text{ odd.} \end{cases}$$

The action (5–11) of \mathbb{Z}_2 reduces to the inversion for q even and the trivial action for q odd. Thus we further need

$$H_{\mathbb{Z}_2, \text{id}}^p(U(1)) = \begin{cases} \mathbb{Z}_2 & \text{if } p \text{ even} \\ 0 & \text{if } p \text{ odd} \end{cases}$$

and

$$H_{\mathbb{Z}_2, \text{id}}^p(\mathbb{Z}_m) = \begin{cases} \mathbb{Z}_m & \text{if } p = 0 \\ \mathbb{Z}_2 & \text{if } p > 0 \text{ and } m \text{ even} \\ 0 & \text{if } p > 0 \text{ and } m \text{ odd.} \end{cases}$$

Now we have calculated the second page of the Lyndon-Hochschild-Serre spectral sequence, namely:

$$E_2^{p,q} = \begin{array}{cccc} | & 0 & & \\ | & \mathbb{Z}_m & 0 & \\ | & 0 & 0 & 0 \\ | & \mathbb{Z}_m & 0 & 0 & 0 \\ | & \mathbb{Z}_2 & 0 & \mathbb{Z}_2 & 0 & \mathbb{Z}_2 \end{array} \quad (\text{for } m \text{ odd})$$

Since there are no non-trivial homomorphisms from \mathbb{Z}_m to \mathbb{Z}_2 for m odd, the spectral sequence collapses already at the second page, and we conclude

$$H_{\Gamma, \epsilon}^n(U(1)) = \begin{cases} \mathbb{Z}_2 & \text{if } n \text{ even} \\ \mathbb{Z}_m & \text{if } n \text{ odd.} \end{cases} \quad (\text{for } m \text{ odd})$$

For m even, the second page is:

$$E_2^{p,q} = \begin{array}{cccc} | & 0 & & \\ | & \mathbb{Z}_m & \mathbb{Z}_2 & \\ | & 0 & 0 & 0 \\ | & \mathbb{Z}_m & \mathbb{Z}_2 & \mathbb{Z}_2 & \mathbb{Z}_2 \\ | & \mathbb{Z}_2 & \xrightarrow{d_2^{0,1}} 0 & \mathbb{Z}_2 & \xrightarrow{d_2^{2,1}} 0 & \mathbb{Z}_2 \end{array} \quad (\text{for } m \text{ even})$$

Here it is at first sight not clear what the homomorphism $d_2^{0,1} : \mathbb{Z}_m \rightarrow \mathbb{Z}_2$ does. It is shown in [Sah74] that there exists a *seven term exact sequence*, associated to the semi-direct product $\Gamma = \mathbb{Z}_2 \ltimes Z$ and a Γ -module M , namely:

$$\begin{array}{ccccccc}
0 & \longrightarrow & H_{\mathbb{Z}_2, \text{id}}^1(H_Z^0(M)) & \longrightarrow & H_{\Gamma, \epsilon}^1(M) & \xrightarrow{\text{res}} & H_{\mathbb{Z}_2, \text{id}}^0(H_Z^1(M)) \\
& & & & & & \downarrow d_2^{0,1} \\
& & & & & & H_{\mathbb{Z}_2, \text{id}}^2(H_Z^0(M)) & \longrightarrow & H_{\Gamma, \epsilon}^2(M)_1 & \longrightarrow & H_{\mathbb{Z}_2, \text{id}}^1(H_Z^1(M)) \\
& & & & & & & & & & \downarrow d_2^{1,1} \\
& & & & & & & & & & H_{\mathbb{Z}_2, \text{id}}^3(H_Z^0(M))
\end{array}$$

Here, res denotes the restriction map and $H_{\Gamma, \epsilon}^2(M)_1$ is defined by the exact sequence

$$0 \longrightarrow H_{\Gamma, \epsilon}^2(M)_1 \longrightarrow H_{\Gamma, \epsilon}^2(M) \longrightarrow H_Z^2(M)^{\mathbb{Z}_2},$$

where the last group is the subgroup of \mathbb{Z}_2 -invariant elements of $H_Z^2(M)$. In our situation of a cyclic subgroup Z the restriction map is surjective, and $H_Z^2(\mathbb{U}(1)) = 0$, so that $H_{\Gamma, \epsilon}^2(\mathbb{U}(1))_1 \cong H_{\Gamma, \epsilon}^2(\mathbb{U}(1))$. Together with the calculations above, for $Z = \mathbb{Z}_m$ with m even the seven term exact sequence reduces to

$$0 \longrightarrow H_{\Gamma, \epsilon}^1(\mathbb{U}(1)) \xrightarrow{\text{res}} \mathbb{Z}_m \xrightarrow{d_2^{0,1}} \mathbb{Z}_2 \longrightarrow H_{\Gamma, \epsilon}^2(\mathbb{U}(1)) \longrightarrow \mathbb{Z}_2 \longrightarrow 0$$

In particular, res is an isomorphism and $d_2^{0,1} = 0$. So we conclude

$$H_{\Gamma, \epsilon}^n(\mathbb{U}(1)) = \begin{cases} \mathbb{Z}_2 & \text{if } n = 0 \\ \mathbb{Z}_m & \text{if } n = 1 \\ \mathbb{Z}_4 \text{ or } \mathbb{Z}_2 \times \mathbb{Z}_2 & \text{if } n = 2 \\ \mathbb{Z}_{2k} \text{ or } \mathbb{Z}_2 \times \mathbb{Z}_k & \text{if } n = 3, \text{ for } k = m, \frac{m}{2}, \frac{m}{4} \end{cases} \quad (\text{for } m \text{ even})$$

By an explicit calculation one can show that $H_{\Gamma, \epsilon}^2(\mathbb{U}(1))$ is actually $\mathbb{Z}_2 \times \mathbb{Z}_2$ and not \mathbb{Z}_4 [GSW].

Finally, we need the cohomology groups $H_{\Gamma, \epsilon}^n(\mathbb{U}(1))$ for the case when the normal subgroup is $Z = \mathbb{Z}_2 \times \mathbb{Z}_2$. We have

$$H_{\mathbb{Z}_2 \times \mathbb{Z}_2}^q(\mathbb{U}(1)) = \begin{cases} \mathbb{U}(1) & \text{if } q = 0 \\ \mathbb{Z}_2 \times \mathbb{Z}_2 & \text{if } q = 1 \\ \mathbb{Z}_2 & \text{if } q = 2 \\ \mathbb{Z}_2 \times \mathbb{Z}_2 & \text{if } q = 3. \end{cases}$$

It follows then from the spectral sequence, that $H_{\Gamma, \epsilon}^2(\mathbb{U}(1))$ is of order less or equal to 16. By an explicit calculation [GSW], one finds:

$$H_{\Gamma,\epsilon}^2(\mathbb{U}(1)) = \mathbb{Z}_2 \times \mathbb{Z}_2 \times \mathbb{Z}_2 \times \mathbb{Z}_2 \quad (\text{for } Z = \mathbb{Z}_2 \times \mathbb{Z}_2).$$

Summarizing, we have computed the cohomology group $H_{\Gamma,\epsilon}^2(\mathbb{U}(1))$ in all cases, providing us with the precise number of equivalence classes of Γ^ϵ -equivariant bundle gerbes over G with fixed underlying bundle gerbe. In the situation with $Z = \{0\}$ the trivial group, for which Γ^ϵ -equivariant bundle gerbes are just Jandl gerbes, we have seen that the cohomology group $H_{\mathbb{Z}_2,\text{id}}^3(\mathbb{U}(1))$, where the obstruction class o_3 of the bundle gerbe lives, vanishes. This means:

Lemma 5.6.3. *Let \mathcal{G} be a bundle gerbe over a compact, simple and simply-connected Lie group G with curvature $k\eta$. Then, \mathcal{G} admits Jandl structures for any involution of the form $g \mapsto \zeta \cdot g^{-1}$ for ζ in the center of G , and there exist exactly two inequivalent Jandl gerbes which are isomorphic to \mathcal{G} .*

This reproduces in particular Example 4.5.3. For non-trivial Z , however, the cohomology groups $H_{\Gamma,\epsilon}^3(\mathbb{U}(1))$ do not vanish, and one has to derive the obstruction classes $o_3(\mathcal{G}_0^k)$ for every basic bundle gerbe explicitly. This has been accomplished in [GSW], the results being collected in Table 5.2.

Applied to Wess-Zumino-Witten models, Table 5.2 contains all obstructions against the existence of such a model for unoriented worldsheets on quotients G/Z of a compact, simple and simply connected Lie group G in terms of the level k , the subgroup Z and the choice of the twist element ζ . In the case that the obstruction vanishes, the number of gauge equivalence classes of Wess-Zumino-Witten models for unoriented worldsheets on G/Z is given by the order of the cohomology group $|H_{\Gamma,\epsilon}^2(\mathbb{U}(1))|$ divided by two: this factor has to be taken into account according to Definition 4.5.2.

G	Center	Z	k	$o_3(k) = 0$ if...	$ H_{T,\epsilon}^2(U(1)) $	
$SU(n)$	\mathbb{Z}_n	$\{0\}$	all	always	2	
		\mathbb{Z}_{2m}	even odd	always ζ and $\frac{n}{2m}$ even	4	
		\mathbb{Z}_{2m+1}	all	always	2	
$Spin(n)$	$n = 2r + 1$	\mathbb{Z}_2	$\{0\}$	all	always	2
			\mathbb{Z}_2	all	always	4
	$n = 4r + 2$	\mathbb{Z}_4	$\{0\}$	all	always	2
			\mathbb{Z}_2	even odd	always ζ even	4
			\mathbb{Z}_4	even odd	always never	4
	$n = 4r$	$\mathbb{Z}_2 \times \mathbb{Z}_2$	$\{0\}$	all	always	2
			$\mathbb{Z}_2^{\text{right}}$	even odd	always $\zeta = (0, x)$	4
			$\mathbb{Z}_2^{\text{left}}$	even odd	always r even and $\zeta = (x, 0)$	4
			$\mathbb{Z}_2^{\text{diag}}$	even odd	always r even and $\zeta = (x, x)$	4
			$\mathbb{Z}_2 \times \mathbb{Z}_2$	even odd	always never	16
$Sp(2n)$	\mathbb{Z}_2	$\{0\}$	all	always	2	
		\mathbb{Z}_2	even odd	always n even	4	
E_6	\mathbb{Z}_3	all	all	always	2	
E_7	\mathbb{Z}_2	$\{0\}$	even odd	always never	2	
		\mathbb{Z}_2	all	always	4	
E_8, F_4, G_2	$\{0\}$	$\{0\}$	all	always	2	

Table 5.2: Obstructions and classification of twisted equivariant structures on the bundle gerbes \mathcal{G}_0^k over compact, simple and simply-connected Lie groups. For example, the bundle gerbe \mathcal{G}_0^k over $SU(8)$ admits $\mathbb{Z}_2 \times \mathbb{Z}_4$ -equivariant structures, if k is even or if the twist element ζ is even.

Summary

Gerbes are geometrical objects which can be understood as generalizations of fibre bundles. In particular gerbes can be equipped with connections; their holonomy has been discussed in this thesis. This holonomy is not defined on closed curves as for fibre bundles, but on closed oriented surfaces.

In theoretical physics the geometrical description of so-called Wess-Zumino-Witten models has been substantially improved by connections on gerbes and their holonomy: an important component of its action functional, the Wess-Zumino term, has been identified as the holonomy of a gerbe around the worldsheet. Based on this fact connections on gerbes now offer the possibility to define Wess-Zumino-Witten models for more complicated types of worldsheets in a geometrical setup, namely

- 1.) for oriented surfaces with boundary,
- 2.) for oriented surfaces with defect lines and
- 3.) for unoriented surfaces.

To extend the original holonomy to these more general situations requires the choice of additional structures on gerbes with connection. For oriented surfaces with boundary it is well-known that this additional structure consists of a gerbe module that is defined over a region in which the boundary of the surface lies. In the context of Wess-Zumino-Witten models such gerbe modules are called D-branes.

In this thesis we have introduced additional structures appropriate for the remaining two situations, and have applied them to Wess-Zumino-Witten models. For this purpose, we first discussed the mathematical structure of bundle gerbes with connection in the context of 2-categories. We have achieved a substantial simplification of this 2-category by an improved definition of morphisms between gerbes. We have identified gerbe modules as certain in general non-invertible morphisms, so that we have been able to explain D-branes and their holonomy for oriented surfaces with boundary in a more compact and concise manner.

The defect lines we consider are certain embedded circles which divide a surface into several regions to which in general different gerbes can be assigned. In this thesis we have introduced gerbe bimodules and bi-branes, and have shown that they merge the holonomies of these different gerbes to a well-defined quantity. We have thus enabled a geometric description of sigma models with topological defect lines.

In particular, we have examined in this description the geometry of those bi-branes in Wess-Zumino-Witten models that are relevant for conformal field theories. We have been able to identify the submanifolds they are based on as biconjugacy classes in the cartesian product of the involved Lie groups.

A further interesting observation of this thesis concerns the fusion of defect lines which arises naturally in conformal field theory. We have shown that it leads – in the description by bi-branes we suggested – to a new realization of the moduli space of flat connections on a three-punctured sphere.

In order to define holonomy for unoriented and in particular unorientable surfaces, we have introduced the notion of a Jandl structure on a bundle gerbe. For this purpose we have used the 2-categorical structure of gerbes compiled before. Jandl structures add terms to the original holonomy that compensate changes of local orientations in such a way that a well-defined quantity appears, even if no global orientation is selected or does not even exist.

We have suggested how the holonomy of gerbes with Jandl structure defined like this can be used to define Wess-Zumino terms for unoriented world-sheets. We have thus achieved a geometric description of unoriented Wess-Zumino-Witten models.

Not every bundle gerbe permits Jandl structures, and if it does, there may be inequivalent choices. We have developed a cohomology theory in which appropriate obstruction classes live, and whose cohomology groups label the inequivalent choices. Since many examples of bundle gerbes appear as quotient bundle gerbes, we have likewise introduced an equivariant version of this cohomology theory: twisted equivariant Deligne cohomology.

Another important result of this thesis is the computation of all obstruction classes and all those cohomology groups of twisted equivariant Deligne cohomology, which are relevant for Jandl structures on gerbes that define Wess-Zumino-Witten models on compact, simple Lie groups. We have thereby classified all unoriented Wess-Zumino-Witten models on these Lie groups completely. Our results reproduce some well-established results from the algebraic approach to conformal field theory in a geometrical way.

Zusammenfassung (Summary in german)

Gerben sind geometrische Objekte die als Verallgemeinerung von Faserbündeln verstanden werden können. Insbesondere können Gerben mit Zusammenhängen ausgestattet werden; ihre Holonomie haben wir in dieser Arbeit untersucht. Diese Holonomie wird nicht wie bei Faserbündeln auf geschlossenen Kurven ausgewertet, sondern auf geschlossenen, orientierten Flächen.

In der theoretischen Physik konnte mit Hilfe von Zusammenhängen auf Gerben und ihrer Holonomie in den letzten Jahren die geometrische Beschreibung sogenannter Wess-Zumino-Witten Modelle wesentlich verbessert werden: ein wichtiger Bestandteil des Wirkungsfunktionals, der Wess-Zumino Term, wurde als Holonomie einer Gerbe um die Weltfläche erkannt. Beruhend auf dieser Tatsache bietet die Theorie von Zusammenhängen auf Gerben nun die Möglichkeit, Wess-Zumino-Witten Modelle für kompliziertere Typen von Weltflächen geometrisch zu diskutieren, nämlich

- 1.) orientierte Flächen mit Rand,
- 2.) orientierte Flächen mit Defektlinien und
- 3.) nicht-orientierte Flächen.

In jeder dieser Situationen ist die ursprüngliche Holonomie nicht wohldefiniert, und man muss Zusatzstrukturen für Gerben mit Zusammenhang wählen. Für orientierte Flächen mit Rand ist bekannt, dass diese Zusatzstruktur aus einem Gerbenmodul besteht, der über einem Gebiet definiert ist, in dem der Rand der Fläche liegt. Im Kontext von Wess-Zumino-Witten Modellen werden solche Gerbenmoduln als D-branes bezeichnet.

In dieser Arbeit haben wir Zusatzstrukturen für die verbleibenden beiden Situationen eingeführt, untersucht und auf Wess-Zumino-Witten Modelle angewendet. Grundlegend dafür haben wir die mathematische Struktur von Bündelgerben mit Zusammenhängen im Rahmen der Theorie von 2-Kategorien dargestellt. Hierbei konnten wir durch eine verbesserte Definition von Morphismen zwischen Gerben eine wesentliche Vereinfachung dieser 2-Kategorie erreichen. Wir haben außerdem Gerbenmoduln als gewisse, im Allgemeinen nicht-invertierbare Morphismen identifiziert, und konnten so D-branes und ihre Holonomie für orientierte Flächen mit Rand in kompakterer Weise erklären.

Die in Punkt 2.) auftretenden Defektlinien sind eingebettete Kreise, die eine Fläche in verschiedene Gebiete zerlegen; diesen Gebieten können dann im Allgemeinen unterschiedliche Gerben zugeordnet werden. Wir haben in dieser Arbeit Gerbenbimoduln und Bi-branes eingeführt und gezeigt, dass sie die einzelnen Holomomien dieser Gerben über die jeweiligen Gebiete zu einer wohldefinierten Größe verbinden.

So haben wir eine geometrische Beschreibung von Sigma-Modellen mit topologischen Defektlinien ermöglicht. Insbesondere konnten wir in dieser Beschreibung die Geometrie der für konforme Feldtheorien relevanten Bi-branes in Wess-Zumino-Witten Modellen untersuchen. Wir konnten dabei die zugrunde liegenden Untermannigfaltigkeiten als Bikonjugationsklassen im kartesischen Produkt der entsprechenden Liegruppen identifizieren.

Eine weitere interessante Beobachtung dieser Arbeit ist, dass die in der konformen Feldtheorie natürlich auftretende Fusion von Defektlinien in der von uns vorgeschlagenen Beschreibung durch Bi-branes zu einer neuen Realisierung des Moduli-Raumes flacher Zusammenhänge auf einer dreipunktierten Sphäre führt.

Um Holonomie für nicht-orientierte und insbesondere nicht orientierbare Flächen zu definieren, haben wir Jandl Strukturen auf Bündelgerben eingeführt. Dabei konnten wir die zuvor erarbeitete 2-kategorielle Struktur von Gerben sinnvoll einsetzen. Jandl Strukturen fügen der ursprünglichen Holonomie Terme hinzu, die Änderungen von lokalen Orientierungen so kompensieren, dass eine wohldefinierte Größe entsteht, auch wenn keine globale Orientierung gewählt ist oder eine solche nicht existiert.

Wir haben Vorschläge gemacht, wie die so definierte Holonomie von Gerben mit Jandl Struktur zur Definition des Wess-Zumino Terms für nicht-orientierte Weltflächen genutzt werden kann. Damit haben wir eine geometrische Beschreibung nicht-orientierter Wess-Zumino-Witten Modelle erhalten.

Nicht jede Gerbe erlaubt Jandl Strukturen, und falls doch, kann es nicht-äquivalente Wahlen geben. Wir haben in dieser Arbeit eine Kohomologietheorie entwickelt, in der entsprechende Obstruktionsklassen leben, und deren Kohomologiegruppen nicht-äquivalente Wahlen parameterisieren. Da viele Beispiele von Gerben durch Quotientenbildung entstehen, haben wir ebenfalls eine equivariante Version dieser Kohomologietheorie eingeführt: getwistete equivariante Deligne-Kohomologie.

Ein wichtiges Resultat dieser Arbeit ist die Berechnung aller Obstruktionsklassen und Kohomologiegruppen der getwisteten equivarianten Deligne Kohomologie, die für Jandl Strukturen auf denjenigen Gerben relevant sind, die Wess-Zumino-Witten Modelle auf kompakten, einfachen Liegruppen definieren. Wir haben damit alle nicht-orientierten Wess-Zumino-Witten Modelle auf diesen Liegruppen vollständig klassifiziert. Unsere Ergebnisse reproduzieren einige bekannte Resultate aus dem algebraischen Zugang zu konformer Feldtheorie auf geometrische Art und Weise.

Bibliography

- [Alv85] O. Alvarez, *Topological Quantization and Cohomology*, Commun. Math. Phys. **100**, 279–309 (1985).
- [AMM98] A. Alekseev, A. Malkin and E. Meinrenken, *Lie Group Valued Moment Maps*, J. Differential Geom. **48**(3), 445–495 (1998), [dg-ga/9707021](#).
- [Bar04] T. Bartels, *2-Bundles and Higher Gauge Theory*, PhD thesis, University of California, Riverside, 2004.
- [BCM⁺02] P. Bouwknegt, A. L. Carey, V. Mathai, M. K. Murray and D. Stevenson, *Twisted K-Theory and K-Theory of Bundle Gerbes*, Commun. Math. Phys. **228**(1), 17–49 (2002), [hep-th/0106194](#).
- [BCW01] C. Bachas, N. Couchoud and P. Windey, *Orientifolds of the 3-Sphere*, JHEP **12**, 003 (2001), [hep-th/0111002](#).
- [BG88] M. Berger and B. Gostiaux, *Differential Geometry: Manifolds, Curves, and Surfaces*, volume 115 of *Graduate Texts in Mathematics*, Springer, 1988.
- [BL03] J. C. Baez and L. Langford, *Higher-Dimensional Algebra IV: 2-Tangles*, Adv. Math. (180), 705–764 (2003), [math/9811139](#).
- [Bou68] N. Bourbaki, *Éléments de Mathématique. Fasc. XXXIV. Groupes et algèbres de Lie. Chapitre IV-VI*, Hermann, 1968.
- [BPS92] M. Bianchi, G. Pradisi and A. Sagnotti, *Toroidal Compactification and Symmetry Breaking in Open-String Theories*, Nucl. Phys. B **376**, 365–386 (1992).
- [Bre93] G. E. Bredon, *Topology and Geometry*, Graduate Texts in Mathematics, Springer, 1993.
- [Bru02] I. Brunner, *On Orientifolds of WZW Models and their Relation to Geometry*, JHEP **01**, 007 (2002), [hep-th/0110219](#).
- [Bry] J.-L. Brylinski, *Gerbes on complex reductive Lie Groups*, [math/0002158](#).
- [Bry93] J.-L. Brylinski, *Loop spaces, Characteristic Classes and Geometric Quantization*, volume 107 of *Progress in Mathematics*, Birkhäuser, 1993.
- [BS07] J. Baez and U. Schreiber, *Higher Gauge Theory*, in *Categories in Algebra, Geometry and Mathematical Physics*, edited by A. Davydov, Proc. Contemp. Math, AMS, Providence, Rhode Island, 2007, [math/0511710](#).
- [BT82] R. Bott and L. W. Tu, *Differential Forms in Algebraic Topology*, volume 82 of *Graduate Texts in Mathematics*, Springer, 1982.
- [Car36] E. Cartan, *La Topologie des Espaces Représentatifs des Groupes de Lie*, Actual. Sci. et Industr. (358) (1936).
- [Cha98] D. S. Chatterjee, *On the Construction of Abelian Gerbes*, PhD thesis, Cambridge Univ., 1998.
- [CJM02] A. L. Carey, S. Johnson and M. K. Murray, *Holonomy on D-Branes*, J. Geom. Phys. **52**(2), 186–216 (2002), [hep-th/0204199](#).
- [CMM97] A. Carey, J. Mickelsson and M. Murray, *Index Theory, Gerbes, and Hamiltonian Quantization*, Commun. Math. Phys. **183**, 707–722 (1997), [hep-th/9511151](#).
- [DD63] J. Dixmier and A. Douady, *Champs continus d’Espaces Hilbertiens et de C*-algèbres*, Bull. Soc. Math. Fr. **91**, 227–284 (1963).
- [Del91] P. Deligne, *Le Symbole modéré*, Publ. Math. IHES **73**, 147–181 (1991).
- [FFFS00] G. Felder, J. Fröhlich, J. Fuchs and C. Schweigert, *The Geometry of WZW Branes*, J. Geom. Phys. **34**, 162–190 (2000), [hep-th/9909030](#).

- [FFRS04] J. Fröhlich, J. Fuchs, I. Runkel and C. Schweigert, *Kramers-Wannier Duality from conformal Defects*, Phys. Rev. Lett. **93** (2004), [cond-mat/0404051](#).
- [FFRS06] J. Fjelstad, J. Fuchs, I. Runkel and C. Schweigert, *TFT Construction of RCFT Correlators V: Proof of modular Invariance and Factorisation*, Theory Appl. Categories (16), 342–433 (2006), [hep-th/0503194](#).
- [FG94] J. Fröhlich and K. Gawędzki, *Conformal Field Theory and Geometry of Strings*, in *Mathematical Quantum Theory I: Field Theory and Many Body Theory*, edited by J. F. et al., page 57, AMS, 1994, [hep-th/9310187](#).
- [FGK88] G. Felder, K. Gawędzki and A. Kupiainen, *Spectra of Wess-Zumino-Witten Models with arbitrary simple Groups*, Commun. Math. Phys. **177**, 127–158 (1988).
- [FOS01] J. M. Figueroa-O’Farrill and S. Stanciu, *D-Brane Charge, Flux Quantisation and relative (Co)Homology*, JHEP **01**, 006pp (2001), [hep-th/0008038](#).
- [Fro96] F. G. Frobenius, *Über Gruppencharaktere*, Sitzungsber. Preuss. Akad. Wiss. **985** (1896).
- [FRS02] J. Fuchs, I. Runkel and C. Schweigert, *TFT Construction of RCFT Correlators I: Partition Functions*, Nucl. Phys. B **646**, 353 (2002), [hep-th/0204148](#).
- [FRS04] J. Fuchs, I. Runkel and C. Schweigert, *TFT Construction of RCFT Correlators II: unoriented World Sheets*, Nucl. Phys. B **678**(3), 511–637 (2004), [hep-th/0306164](#).
- [FSW] J. Fuchs, C. Schweigert and K. Waldorf, *Bi-Branes: Target Space Geometry for World Sheet topological Defects*, [hep-th/0703145](#), submitted.
- [Gaw] K. Gawędzki, *Conformal Field Theory: A Case Study*, [hep-th/9904145](#).
- [Gaw88] K. Gawędzki, *Topological Actions in two-dimensional Quantum Field Theories*, in *Non-perturbative Quantum Field Theory*, edited by G. Hooft, A. Jaffe, G. Mack, K. Mitter and R. Stora, pages 101–142, Plenum Press, 1988.
- [Gaw05] K. Gawędzki, *Abelian and non-Abelian Branes in WZW Models and Gerbes*, Commun. Math. Phys. **258**, 23–73 (2005), [hep-th/0406072](#).
- [Gir71] J. Giraud, *Cohomologie non-abélienne*, Grundle. der math. Wiss. **197** (1971).
- [God58] R. Godement, *Topologie algébrique et Théorie des Faisceaux*, Hermann, Paris, 1958.
- [Gom03] K. Gomi, *Equivariant smooth Deligne Cohomology*, Osaka J. Math. **42**(2), 309–337 (2003), [math/0307373](#).
- [GR02] K. Gawędzki and N. Reis, *WZW Branes and Gerbes*, Rev. Math. Phys. **14**(12), 1281–1334 (2002), [hep-th/0205233](#).
- [GR03] K. Gawędzki and N. Reis, *Basic Gerbe over non simply connected compact Groups*, J. Geom. Phys. **50**(1–4), 28–55 (2003), [math.dg/0307010](#).
- [GSW] K. Gawędzki, R. R. Suszek and K. Waldorf, *WZW Orientifolds and Finite Group Cohomology*, [hep-th/0701071](#), submitted.
- [GT01] K. Gomi and Y. Terashima, *Higher-dimensional parallel Transports*, Math. Research Letters **8**, 25–33 (2001).
- [Hit01] N. Hitchin, *Lectures on Special Lagrangian Submanifolds*, Adv. Math. (23), 151–182 (2001), [math/9907034](#).
- [Hit03] N. Hitchin, *Generalized Calabi-Yau Manifolds*, Quart. J. Math. Oxford Ser. , 281–308 (2003), [math/0209099](#).
- [Hor99] K. Hori, *D-Branes, T-Duality, and Index Theory*, Adv. Theor. Math. Phys. **3**(2) (1999), [hep-th/3302102](#).

- [HSS02] L. R. Huiszoon, K. Schalm and A. N. Schellekens, *Geometry of WZW orientifolds*, Nucl. Phys. B **624**(1–2), 219–252 (2002), [hep-th/0110267](#).
- [Jan95] E. Jandl, *lechts und rinks*, Luchterhand Literaturverlag, 1995.
- [JW92] L. C. Jeffrey and J. Weitsman, *Bohr-Sommerfeld Orbits in the Moduli Space of flat Connection s and the Verline Dimension Formula*, Commun. Math. Phys. **150**(593) (1992).
- [Kap00] A. Kapustin, *D-branes in a topologically nontrivial B-field*, Adv. Theor. Math. Phys. **4**, 127 (2000), [hep-th/9909089](#).
- [Kos70] B. Kostant, *Quantization and unitary Representations*, volume 170 of *Lecture Notes in Mathematics*, Springer, 1970.
- [LU01] E. Lupercio and B. Uribe, *Digne Cohomology for Orbifolds, discrete Torsion and B-fields*, in *Proceedings of the Summer School "Geometric and Topological methods for Quantum Field Theory"*, Villa de Leyva, Colombia, 2001, [hep-th/0201184](#).
- [Mei02] E. Meinrenken, *The Basic Gerbe over a compact simple Lie Group*, Enseign. Math., II. Sér. **49**(3–4), 307–333 (2002), [math/0209194](#).
- [Moe] I. Moerdijk, *Introduction to the Language of Stacks and Gerbes*, [math.AT/0212266](#), Summer school lecture notes.
- [MS00] M. K. Murray and D. Stevenson, *Bundle Gerbes: Stable Isomorphism and local Theory*, J. Lond. Math. Soc. **62**, 925–937 (2000), [math/9908135](#).
- [Mur96] M. K. Murray, *Bundle Gerbes*, J. Lond. Math. Soc. **54**, 403–416 (1996), [dg-ga/9407015](#).
- [Pol] J. Polchinski, *TASI Lectures on D-Branes*, [hep-th/9611050](#), Lecture notes.
- [PS86] A. Pressley and G. Segal, *Loop Groups*, Oxford Univ. Press, 1986.
- [PSS95a] G. Pradisi, A. Sagnotti and Y. S. Stanev, *The Open descendants of nondiagonal $SU(2)$ WZW models*, Phys. Lett. B **356**, 230–238 (1995), [hep-th/9506014](#).
- [PSS95b] G. Pradisi, A. Sagnotti and Y. S. Stanev, *Planar duality in $SU(2)$ WZW models*, Phys. Lett. B **354**, 279–286 (1995), [hep-th/9503207](#).
- [PZ01] V. B. Petkova and J.-B. Zuber, *Generalized twisted Partition Functions*, Phys. Lett. B **504**, 157 (2001), [hep-th/0011021](#).
- [Sah74] C.-H. Sah, *Cohomology of Split Group Extensions*, Journal of Algebra **29**, 255–302 (1974).
- [SSW07] U. Schreiber, C. Schweigert and K. Waldorf, *Unoriented WZW Models and Holonomy of Bundle Gerbes*, Commun. Math. Phys. **274**(1), 31–64 (2007), [hep-th/0512283](#).
- [Ste00] D. Stevenson, *The Geometry of Bundle Gerbes*, PhD thesis, University of Adelaide, 2000, [math.DG/0004117](#).
- [SWa] U. Schreiber and K. Waldorf, in preparation.
- [SWb] U. Schreiber and K. Waldorf, *Parallel Transport and Functors*, [arxiv:0705.0452](#), submitted.
- [VFPS97] P. D. Vecchia, M. Frau, I. Pesando and S. Sciuto, *Classical p -Branes from Boundary State*, Nucl. Phys. B **507**, 259 (1997), [hep-th/9707068](#).
- [WA94] E. Wong and I. Affleck, *Tunneling in Quantum Wires: A boundary Conformal Field Theory Approach*, Nucl. Phys. B **417**, 403 (1994), [cond-mat/9311040](#).
- [Wal00] R. Waldrop, *Reft and Light: Poems by Ernst Jandl with multiple Versions by Amercian Poets*, Burning Deck Press, Providence, 2000.

- [Wal06] K. Waldorf, Surface Holonomy, in *Handbook of pseudo-Riemannian Geometry and Supersymmetry*, edited by V. Cortés, IRMA Lectures in Mathematics and Theoretical Physics, European Mathematical Society, Zürich, 2006.
- [Wal07] K. Waldorf, *More Morphisms between Bundle Gerbes*, Theory Appl. Categories **18**(9), 240–273 (2007), [math.CT/0702652](#).
- [Wei52] A. Weil, *Sur les Théorèmes de de Rham*, Commun. Math. Helv. **26**, 17–43 (1952).
- [Wei94] C. A. Weibel, *An Introduction to Homological Algebra*, Number 38 in Cambridge Studies in Advanced Mathematics, Cambridge Univ. Press, 1994.
- [Wit84] E. Witten, *Nonabelian Bosonization in two Dimensions*, Commun. Math. Phys. **92**, 455–472 (1984).
- [Wit98] E. Witten, *D-Branes and K-Theory*, JHEP **9812**(019) (1998), [hep-th/9810188v2](#).

List of Notations

$()^{-1}$	functor which assigns inverses to 1-isomorphisms, 53
$()^\dagger$	2-endofunctor on $\mathfrak{BGrb}(M)$ which combines the duality 2-functor $()^*$ with the functor $()^{-1}$, 122
$\mathbb{1}$	trivial line bundle with the trivial flat connection, 1
$\mathbb{1}_{\pm 1}^k$	trivial flat line bundle with its two k -equivariant structure, 105
$\mathcal{A}_{g,\mathcal{G}}(\phi, \Sigma)$	Feynman amplitude in a sigma model for oriented world-sheets, 32
$\mathcal{A}_{\mathfrak{M},\mathcal{D}}(\{\phi_k\}, \Sigma)$	Feynman amplitude in a sigma model with boundary and defects, 88
$\mathcal{A}_{g,\mathcal{G},k}^{\text{orble}}(\hat{\phi}, \Sigma)$	Feynman amplitude in a sigma model for orientable world-sheets, 98
$\mathcal{A}_{g,\mathcal{G},\mathcal{T}}^{\text{unor}}(\hat{\phi}, \Sigma)$	Feynman amplitude in sigma model for unoriented world-sheets, 117
$\mathfrak{Aut}(\mathcal{G})$	groupoid of automorphisms of a bundle gerbe \mathcal{G} , 54
\mathcal{B}_{h_1,h_2}	biconjugacy class of two points $h_1, h_2 \in G$, 91
$\beta^\#$	2-morphism between inverse 1-isomorphisms, 52
$\mathfrak{BGrb}(M)$	2-category of bundle gerbes over M , 48
$\mathcal{G}\text{-}\mathcal{H}\text{-}\mathfrak{Bimod}$	category of $\mathcal{G}\text{-}\mathcal{H}$ -bimodules, 81
$\mathfrak{Bun}_{\rho_2-\rho_1}(M)$	category of vector bundles over M whose curvature is of trace $\rho_2 - \rho_1$, 57
\mathcal{Bun}	the sheaf of categories that assigns categories of vector bundles, 55
Bun	canonical functor $\mathfrak{Hom}(\mathcal{I}_{\rho_1}, \mathcal{I}_{\rho_2}) \rightarrow \mathfrak{Bun}_{\rho_2-\rho_1}(M)$, 57
$C_T^k(A)$	cochain groups associated to a T -module A , 129
\mathcal{C}_{μ_i}	conjugacy class corresponding to the weight μ_i , 25
\mathcal{Con}	2-functor which reconstructs bundle gerbes from cocycles, 65
$C^\infty(\hat{\Sigma}, M)^{\sigma,k}$	space of smooth maps $\hat{\phi} : \hat{\Sigma} \rightarrow M$ which commute with involutions σ and k , 97
$\text{curv}(L)$	curvature of a hermitian line bundle with connection, identified with a 2-form, 2
$\text{curv}(\mathcal{G})$	curvature of a bundle gerbe \mathcal{G} , 4
$\check{C}^\bullet(\mathfrak{A}, \mathcal{A})$	Čech complex of an abelian sheaf \mathcal{A} and an open cover \mathfrak{A} , 13
\mathcal{C}_ξ	bundle gerbe constructed from a Deligne cocycle ξ , 18
D	Deligne coboundary operator, 13
d	exterior derivative on differential forms, 12
d	group homomorphism $d : H^k(M, \mathcal{D}(k)) \rightarrow \Omega_{\text{cl}}^{k+1}(M)$, 20
$dd(\mathcal{G})$	Dixmier-Douady class of a bundle gerbe, 21
$\mathfrak{Del}^2(\mathfrak{A})$	the 2-category defined from Čech-Deligne cochains, 64
Δ	coboundary operator of the group cohomology complex, 129

$\mathcal{D}\text{es}(\mathcal{F}, \pi)$	descent category associated to a presheaf \mathcal{F} of categories and a surjective submersion π , 55
$\mathcal{D}_{\mathcal{G}}$	duality 1-isomorphism associated to a bundle gerbe \mathcal{G} , 8
D_{Γ}	coboundary operator of the complex $\text{Tot}_{\Gamma}^{\bullet}(\mathfrak{B}, \mathcal{D}(n))$, 130
dlog	sheaf homomorphism $\text{dlog} : \underline{\mathbb{U}}(1)_M \rightarrow \underline{\Omega}_M^1$, 12
$\mathcal{D}^{\bullet}(n)$	Deligne complex in degree n , 13
$\mathcal{E}\text{nd}(\mathcal{G})$	category of endomorphisms of a bundle gerbe \mathcal{G} , 54
$\mathcal{E}\mathfrak{q}(\Gamma^{\epsilon}, \mathcal{G})$	groupoid of twisted equivariant structures on a bundle gerbe \mathcal{G} , 124
η	3-form on a Lie group G which coincides with the canonical 3-form for G compact, simple and simply-connected, 23
\mathcal{G}_0	basic bundle gerbe over a compact, simple and simply-connected Lie group, 23
\mathcal{G}^*	bundle gerbe dual to a bundle gerbe \mathcal{G} , 5
\mathfrak{g}	Lie algebra of a compact Lie group G , 23
\mathcal{G}_f	bundle gerbe obtained from a bundle gerbe \mathcal{G} over M from a morphism f of surjective submersions over M , 9
$H_{\Gamma}^{\bullet}(M, A)$	Γ -equivariant cohomology of M , 104
$H^{\bullet}(M, \mathcal{D}(n))$	Deligne cohomology of M , 13
$H_{\Gamma}^{\bullet}(M, \mathcal{D}(n))$	twisted equivariant Deligne cohomology of M , 130
$\check{H}^{\bullet}(M, \mathcal{K})$	cohomology of the Čech double complex associated to a sheaf complex \mathcal{K}^{\bullet} , 14
$H^{\bullet}(M, Q, \mathbb{R})$	relative cohomology of a smooth manifold M and a submanifold Q , 69
$\text{Hol}_{\mathcal{G}}(\phi, \Sigma)$	holonomy of a bundle gerbe \mathcal{G} around a closed oriented surface Σ , 28
$\text{Hol}_L(\gamma)$	holonomy of a line bundle L around a loop γ , 26
\mathcal{I}_{ρ}	trivial bundle gerbe associated to a 2-form $\rho \in \Omega^2(M)$, 4
$\text{id}_{\mathcal{A}}$	identity 2-morphism associated to a 1-morphism \mathcal{A} , 41
$\text{id}_{\mathcal{G}}$	identity 1-isomorphism associated to a bundle gerbe \mathcal{G} , 8
i_l, i_r	2-isomorphisms associated to an inverse 1-isomorphism, 53
Inv	inversion $g \mapsto g^{-1}$ on a Lie group G , 35
$\mathfrak{I}\mathfrak{s}\mathfrak{o}(\mathcal{G}, \mathcal{H})$	groupoid of isomorphisms between bundle gerbes \mathcal{G} and \mathcal{H} , 53
$\mathfrak{J}\mathfrak{d}\mathfrak{l}(\mathcal{G}, k)$	groupoid of Jandl structures on the bundle gerbe \mathcal{G} with involution k , 103
κ	group homomorphism $H^k(M, \mathcal{D}(n)) \rightarrow H^{k+1}(M, \mathbb{Z})$, 19, 20
$\lambda_{\mathcal{A}}$	natural 2-isomorphism from the 2-category $\mathfrak{B}\mathfrak{e}\mathfrak{r}\mathfrak{b}(M)$, 49
l_h	left multiplication by an element $h \in G$, 34
$\mathfrak{L}\mathfrak{i}\mathfrak{n}_\rho^k(M)$	groupoid of k -equivariant line bundles over M with curvature ρ , 103
$\mathfrak{L}\mathfrak{M}\mathfrak{o}\mathfrak{d}(\mathcal{G})$	category of left \mathcal{G} -modules, 71
$M_{\mathfrak{B}}$	disjoint union of all open sets of an open cover \mathfrak{B} , 1
$o_{i,x}$	the i th obstruction class against twisted equivariant structures, 133–135
$\Omega_{\text{cl}, \mathbb{Z}}^n(M)$	closed n -forms on M with integral class, 19

$\Omega^k(M)$	differential k -forms on M , 2
$\underline{\Omega}_M^k$	sheaf of k -forms on M , 12
$\pi_{i_1 \dots i_r}$	canonical projection $Y^{[k]} \rightarrow Y^{[r]}$, 2
r_h	right multiplication by an element $h \in G$, 34
$\rho_{\mathcal{A}}$	natural 2-isomorphism from the 2-category $\mathfrak{BGrb}(M)$, 49
$\mathfrak{RMod}(\mathcal{G})$	category of right \mathcal{G} -modules, 71
$\hat{\Sigma}$	orientation covering of a surface Σ , 97
σ	canonical involution of an orientation covering, 97
$\bar{\Sigma}$	surface Σ with the opposite orientation, 28
$S_g^{\text{kin}}(\phi, \Sigma)$	kinetic term of a sigma model, 32
$S_{H_1, H_2, \varpi}^{\text{WZ}}$	Wess-Zumino term of a topologically trivial bi-brane, 76
S_H^{WZ}	Wess-Zumino term in Witten's definition, 31
$S_{H, \omega}^{\text{WZ}}$	Wess-Zumino term in a topologically trivial sigma model for worldsheets with boundary, 69
θ	left invariant Maurer-Cartan form on a Lie group G , 13
t_μ	isomorphism $t_\mu : \Delta^*L \rightarrow \mathbb{1}$ associated to any bundle gerbe, 40
$\text{Tot}_\Gamma^\bullet(\mathfrak{V}, \mathcal{D}(n))$	total complex of the Deligne complex-valued group complex, 130
$\text{Tot}^\bullet(\mathfrak{V}, \mathcal{K})$	total complex of a Čech double complex, 13
$\text{tr}(\text{curv}(A))$	trace of the curvature of a vector bundle, identified with a 2-form, 38
\mathfrak{V}	a cover of a smooth manifold M by open sets V_i , 1
x^\otimes	modified pullback 2-functor for twisted equivariant structures on bundle gerbes, 122
$Y^{[k]}$	k -fold fibre product of a surjective submersion with itself, 2

Index

- 1-isomorphism, 52
- 1-morphism, 38
 - invertible, 52
- 2-category, 40, 48
 - of bundle gerbes, 9, 48
 - of Deligne cocycles, 64
 - opposed, 59
- 2-functor, 58, 65
- 2-isomorphism, 9, 39, 42, 43
- 2-morphism, 40
 - invertible, 42
- B-field, 32, 33, 120
- basic bundle gerbe, 23
- bi-brane, 82
 - symmetric, 89, 92, 93
 - topologically trivial, 76
- biconjugacy class, 91, 93
- bundle gerbe, 3
 - dual, 5, 59, 122
 - equivariant, 137
 - flat, 4
 - quotient, 137, 146
 - trivial, 4
 - trivializable, 11, 22
 - twisted equivariant, 127
- bundle gerbe bimodule, 81
- bundle gerbe module, 70
- canonical 3-form, 23
- Chern class, 21
- Chern-Simons theory, 94
- coadjoint orbit, 24
- cochain
 - for a 2-isomorphism, 11
 - for a stable isomorphism, 10, 17
 - for the duality 1-isomor., 17
 - for the identity 1-isomor., 17
- cochains
 - for a Jandl structure, 106, 111
- cocycle
 - for a bundle gerbe, 4, 5, 16, 88
 - for a line bundle, 3, 5, 15
 - for a tensor pr. of bun. ger., 11
 - for a trivialization, 17
- cohomology
 - birelative de Rham, 76, 78, 85
 - Deligne, 13
 - equivariant, 104
 - relative de Rham, 69, 74, 78
 - twisted equivariant Deligne, 130
- complex
 - Čech-Deligne double, 13
 - de Rham, 12
 - Deligne, 13, 128
- composition functor, 43, 44, 48
- composition of 1-morphisms, 43
- composition of 2-morphisms
 - horizontal, 44
 - vertical, 41
- compositor, 66
- conformal field theory, 34, 89, 93
- conjugacy class, 25, 89, 93
- connective structure, 3
- conserved current, 34
- crosscap, 118
- curvature
 - equivariant, 134
 - of a bi-brane, 82
 - of a bundle gerbe, 4, 22
 - of a D-brane, 71
 - of a line bundle, 21
 - of a vector bundle, 38
- curving, 3
- D-brane, 71
 - symmetric, 89, 93
- de Rham isomorphism, 78
- defect line, 75
- descent category, 55
- discrete torsion, 34, 142
- Dixmier-Douady class, 21

- duality 1-isomorphism, 8, 59
- duality 2-functor, 59
- equivalent
 - Jandl gerbes, 108
 - twist. equiv. bundle gerbes, 127
- equivariant smooth map, 97
- equivariant structure
 - on a bundle gerbe, 137
 - on a line bundle, 102, 121
 - on a sheaf, 128
- Feynman amplitude, 32, 76, 86, 88, 98, 117
- field insertions, 87
- field strength, 32
- folding trick, 83
- fundamental alcove, 23
- fundamental domain, 98, 115, 116
- fusion, 93
- gauge equivalent
 - sigma mod. f. oriented worldsh., 32
 - sigma mod. f. unoriented worldsh., 118, 152
- gauge groupoid, 54
- gauge transformation, 32
- geometric quantization, 94
- groupoid
 - of isomorphisms, 53
 - of Jandl structures, 103
- holonomy
 - for a closed loop, 26
 - oriented bi-brane, 83
 - oriented D-brane, 72
 - oriented surface, 27
 - unoriented surface, 108
- Hom-category, 40, 48
- homology
 - birelative, 76
- identity 1-isomorphism, 8
- identity 2-morphism, 41
- isomorphic 1-morphisms, 43
- isomorphism
 - between line bundles, 3
- Jandl gerbe, 107, 144
- Jandl structure, 101
- Kalb-Ramond-field, 120
- kinetic term, 32, 116
- Klein bottle, 114
- level
 - of a WZW model, 33
- line bundle, 3
 - equivariant, 103, 104
 - over a coadjoint orbit, 24
- local data
 - for a gerbe bimodule, 82, 88
 - for a gerbe module, 70, 88
- local orientation, 99
- loop space, 87
- manifold
 - orientable, 96
 - oriented, 96
 - unorientable, 96
- Maurer-Cartan form, 23, 25, 34
- module category, 61, 103
- monodromy, 94
- monoidal structure
 - on the 2-cat. of bun. ger., 58
- morphism
 - betw. twist. equiv. struct., 124
 - between Jandl structures, 102
 - between surjective subm., 9, 54
- multiplication
 - of a bundle gerbe, 2
- obstruction
 - for equivariant line bundles, 104
 - for tw. eq. struc., 132, 136
- open cover
 - good, 14
 - invariant, 111
- orbifold, 142
- orientation
 - on a smooth manifold, 96

- on a surface, 97
- orientation covering
 - of a surface, 97
- orientation-preserving
 - diffeomorphism, 28, 96
 - edge, 99, 112
 - vertex, 113
- orientation-reversing
 - diffeomorphism, 96
 - edge, 99, 112
 - vertex, 113, 116, 118
- orientifold, 148
- orientifold group, 144

- parity symmetry, 35, 98
- parity transformation, 34, 35, 98, 116
- presheaf of categories, 54
- pseudonatural transformation, 66
- pullback
 - of 1- and 2-morphisms, 59
 - of a bundle gerbe, 5

- rank
 - of a bundle gerbe module, 70
- real projective plane, 115

- scattering
 - of bulk fields, 90
- sheaf
 - equivariant, 128
 - of categories, 55
- sigma model
 - for orientable worldsheets, 98
 - for oriented worldsh. with bound., 86
 - for oriented worldsheets, 32, 98
 - for oriented worldsheets with boundary and defects, 88
 - for unoriented worldsheets, 117
 - on the torus, 119
 - topologically trivial, 32, 69
- skeleton
 - of a 2-category, 57, 64
 - of a category, 64

- spectral sequence
 - Lyndon/Hochschild-Serre, 149
- stable isomorphism, 7, 38
- stably isomor. bundle gerbes, 7, 57
- Stokes's Theorem, 27
- symplectic form
 - on an integral coadjoint orbit, 25
 - on the mod. sp. of flat conn., 95

- target space, 32
- tensor product
 - of bimodules, 82
 - of bundle gerbes, 6
- tensor unit, 58
- Thom's Theorem, 31
- torsor, 62, 104
- torsor category, 62, 103
- transgression, 87
- triangulation, 29, 74, 88, 114, 115
- trinion, 94
- trivialization
 - of a bundle gerbe, 11, 58
- twisted equivariant structure, 123
 - descended, 125
 - normalized, 123
- twisted K-theory, 70

- unitor, 66

- vector bundle, 38
 - twisted, 71
- Verlinde formula, 94

- Wess-Zumino term, 69, 76, 117
 - of a top. triv. bi-brane, 76, 80
 - Witten's definition, 31
- Wess-Zumino-Witten model
 - for oriented worldsheets, 33
 - for unoriented worldsheets, 148
- world volume
 - of a bi-brane, 82
 - of a D-brane, 71